



DIGITAL STORAGE OSCILLOSCOPE

SERVICE MANUAL

9314A/C AM/CM/AL/CL

LeCroy Corporation
700 Chestnut Ridge Road
Chestnut Ridge NY 10977-6499 USA
Phone: 1-800-5-LECROY 1-914-425-2000
FAX: 1-914-425-8967
www.lecroy.com

This manual was provided by the Yahoo e-group:

LeCroy_Owners_Group

This manual is free of charge to group members.

The content of this manual is provided courtesy of:

LeCroy Corporation
700 Chestnut Ridge Road
Chestnut Ridge NY 10977

This scan courtesy of S.H. Reaves,
Moderator, LeCroy_Owners_Group

Note: Any copies of this manual must be distributed complete (428 pages inclusive) with this page included, intact and unaltered.

Note: This manual will paginate properly when printed on a duplex 600dpi printer.

LeCroy 9314A, 9314AM & 9314AL
Digital Storage Oscilloscope
Service Manual

Version 1.0

November 1994

First printing

LeCroy
Corporate Headquarters

700 Chestnut Ridge Road
Chestnut Ridge, NY 10977-6499

Tel : (914) 425-2000
Fax : (914) 425-8967

LeCroy
European Headquarters

2, rue du pré-de-la-Fontaine
1217 Meyrin 1 / Geneva, Switzerland

Tel : 41 (022) 719.21.11
Fax : 41 (022) 782.39.15

Table of Contents

Section 1	General Information	Page
1.1	Initial Inspection	1-1
1.2	Warranty	1-1
1.3	Product Assistance	1-1
1.4	Address of Service Centers	1-1
1.5	Maintenance Agreements	1-5
1.6	Documentation Discrepancies	1-5
1.7	Service Procedure	1-5
1.8	Return Procedure	1-5
1.9	Safety Precautions	1-6
1.10	Antistatic Precautions	1-6
Section 2	Specifications	2-1
2.1	9314A/M/L Specifications	2-2
2.2	PCMCIA Hard Disk, Floppy, RAM Card, Internal Printer	2-6
2.3	Active Fet Probes	2-9
2.4	Active Differential Probes	2-11
2.5	Mega Waveform Processing	2-13
2.6	WP01 Waveform Processing Package	2-15
2.7	WP02 Fast Fourier Processing Package	2-18
2.8	LeCalsoft Calibration Software	2-21
Section 3	Block Diagram and Sub-Assemblies	3-1
3.1	9314A Sub-Assemblies	3-1
3.2	9314AM Sub-Assemblies	3-1
3.3	9314AL Sub-Assemblies	3-1
3.4	9314A/M/L Hardware Options	3-1
3.5	9314A Block Diagram	3-2
3.6	9314AM Block Diagram	3-3
3.7	9314AL Block Diagram	3-4
Section 4	Theory of Operation	
4.1	Processor Board for 9314A/M/L	4-1
4.1.1	Parallel Peripherals	4-1
4.1.2	Processor Block Diagram	4-2
4.1.3	Serial Peripherals	4-3
4.1.4	External Interfaces	4-3
4.1.5	Optional Interfaces	4-3
4.2	F9314A/M/L-3 Main Board	4-3
4.2.1	Introduction	4-5
4.2.2	Front End	4-3
4.2.2.1	Channel Description	4-4
4.2.3.2	Digital Controls	4-5
4.2.3.3	Analog Controls	4-6

Section 4	Theory of Operation	Page
4.2.4	Trigger	4-6
4.2.4.1	Digital Controls	4-6
4.2.4.2	Analog Controls	4-7
4.2.4.3	TV Trigger	4-7
4.2.5	Analog to Digital Converter	4-8
4.2.5.1	Introduction	4-8
4.2.6	Time Base	4-8
4.2.6.1	Introduction	4-8
4.2.6.2	Trigger Selection	4-8
4.2.6.3	Smart Trigger	4-8
4.3	F9300-4 GPIB and RS232 Interface	4-9
4.3.1	RS232 Interface	4-9
4.3.2	GPIB Interface	4-9
4.4	F9354-5 Front Panel	4-9
4.5	F9300-6 Centronics Interface	4-9
4.5.1	Centronics Interface Option	4-9
4.5.2	Floppy Disk Drive Interface Option	4-9
4.5.3	Printer Interface Option	4-10
4.6	F9300-7 Printer Controller	4-10
4.7	93XX-Display	4-10
4.7.1	General Description	4-10
4.7.2	Basic Characteristics	4-10
4.7.3	Horizontal Deflection	4-11
4.7.4	Vertical Synchronization	4-12
4.7.5	Horizontal Resolution	4-12
4.7.6	Vertical Resolution	4-12
4.8	93XX-PS1715 Power Supply	4-13
4.8.1	Power Supply Specifications	4-13
4.8.2	Power Supply Block Diagram	4-14
Section 5	Performance Verification	
5.1	Introduction	5-1
5.2	Test Equipment Needed	5-1
5.3	Turn On	5-1
5.4	Input Impedance	5-2
5.4.1	Procedure	5-2
5.4.1.a	DC 1M Ω	5-2
5.4.1.b	DC 50 Ω	5-3
5.4.2	External Trigger Input Impedance	5-4
5.4.2.a	DC 1M Ω	5-4
5.4.2.b	DC 50 Ω	5-5
5.4.3	Internal Protective Resistor Verification	5-6
5.5	Leakage Current	5-7
5.5.1	Procedure	5-7
5.6	Average Noise Level	5-7
5.6.1	Peak to Peak	5-7
5.6.1.a	DC 1M Ω	5-7

Section 5	Performance Verification	Page
5.6.1.b	AC 1M Ω	5-10
5.6.1.c	DC 50 Ω	5-11
5.6.2	Rms Noise	5-12
5.6.2.a	DC 1M Ω	5-12
5.6.2.b	AC 1M Ω	5-14
5.6.2.c	DC 50 Ω	5-14
5.6.3	Inputs Grounded	5-15
5.7	DC Linearity	5-19
5.7.1	Description	5-19
5.7.1.a	DC 50 Ω	5-19
5.7.1.a.1	Positive DC Linearity	5-20
5.7.1.a.2	Negative DC Linearity	5-22
5.7.1.b	DC 1M Ω	5-24
5.8	Offset	5-27
5.8.1	Description	5-27
5.8.1.a	Negative Offset Control	5-27
5.8.1.b	Positive Offset Control	5-30
5.9	Bandwidth	5-33
5.9.1	Description	5-33
5.9.1.a	DC 50 Ω	5-33
5.9.1.a.1	Trigger Bandwidth	5-38
5.9.1.b	DC 1M Ω	5-39
5.10	Trigger Level	5-42
5.10.1	Description	5-42
5.10.2	Channel (Internal)	5-42
5.10.3	External Trigger	5-50
5.10.4	External/10 Trigger	5-58
5.11	Smart Trigger	5-66
5.11.1	Trigger on Pulse Width < 10 nsec	5-66
5.11.2	Trigger on Pulse Width > 10 nsec	5-66
5.11.3	Trigger on Pulse Width < 100 nsec	5-68
5.11.4	Trigger on Pulse Width > 100 nsec	5-69
5.12	Time Base Accuracy	5-70
5.12.1	Description	5-70
5.12.2	100 MHz Clock Accuracy	5-70
5.13	Rise Time and Overshoot	5-74
5.14	Probe Calibrator Verification	5-75
5.15	Overload	5-79
Section 6	Internal Calibration and Diagnostics	
6.1	Introduction	6-1
6.2	Diagnostic Summary	6-2
6.2.1	Gain and Offset Calibration Description	6-3
6.2.2	Trigger Level Calibration	6-3
6.3	Diagnostic Results	6-3
6.3.1	Gain Curves	6-3
6.3.2	Offset Curves	6-4

Section 6	Internal Calibration and Diagnostics	Page
6.3.3	Trigger	6-5
6.3.4	Integral Linearity	6-8
6.4	Board Test Results	6-9
6.5	Probe Bus Verification	6-10
Section 7	Maintenance	
7.1	Introduction	7-1
7.2	Disassembly and Assembly Procedure	7-1
7.2.1	Removal of the Upper Cover	7-1
7.2.2	Removal of the 93XX-PS1715 Power Supply	7-1
7.2.3	Disassembly and Assembly Diagram	7-2
7.2.3.1	Figure 7.1 : 9314A/M/L Assembly	7-3
7.2.3.2	Figure 7.2 : 9314A/M/L Lower Cover Assembly	7-4
7.2.3.3	Figure 7.3 : 9314A/M/L Front Frame Assembly	7-5
7.2.3.4	Figure 7.4 : 9314A/M/L Rear Panel Assembly (ECO 1000)	7-6
7.2.3.5	Figure 7.5 : 9314A/M/L Rear Panel Assembly (ECO 1001)	7-7
7.2.4	Removal of the F9300-4 GPIB and RS232 Interface	7-8
7.2.5	Removal of the Fan	7-8
7.2.6	Removal of the Line Input Module	7-8
7.2.7	Removal of the 93XX-Video	7-8
7.2.8	Removal of the 93XX-Yoke	7-9
7.2.9	Removal of the Front Frame Assembly	7-9
7.2.10	Removal of the 93XX-Deflection	7-9
7.2.11	Removal of the 93XX-CRT	7-10
7.2.12	Removal of the F9354-5 Front Panel	7-10
7.2.13	Removal of the Front Panel Keyboard	7-10
7.2.14	Removal of the Processor	7-11
7.2.15	Removal of the F9314A/M/L-3 Main Board	7-11
7.2.16	Removal of the Handle	7-12
7.2.17	Removal of the Foot Support	7-12
7.2.18	Removal of the 93XX-FD01 Floppy Disk	7-12
7.2.19	Removal of the 93XX-GP01 Graphic Printer	7-12
7.2.19	Removal of the F9300-7 Printer Controller	7-12
7.2.20	Removal of the F9300-6 Centronics Interface	7-12
7.2.21	Figure 7.6 : 9314A/M/L Floppy Option Assembly	7-13
7.2.22	Figure 7.7 : 9314A/M/L Graphic Printer Option Assembly	7-14
7.3	Software Upgrade Procedure	7-15
7.3.1	Upgrading Firmware	7-15
7.3.2	Changing Software Options	7-15
7.3.3	Software Option Selection GAL	7-15
7.3.4	Processor Board Exchange Procedure	7-16
7.4	Equipment and Spare Parts Recommended for Service	7-16
7.4.1	Equipment	7-16
7.4.2	Spare Parts	7-17
7.5	Troubleshooting and Flow Charts	7-18
7.5.1	Introduction	7-18
7.5.2	Line Voltage Autoranging	7-18

Section 7	Maintenance	Page
7.5.3	Initial Troubleshooting Chart	7-18
7.5.4	No Power Supply	7-20
7.5.4.1	Line Fuses Replacement	7-20
7.5.5	No Display	7-21
7.5.6	Front Panel Controls do not Operate	7-22
7.5.7	Abnormal Image on Screen	7-23
7.5.8	No Remote Control GPIB or RS232	7-24
7.5.9	Performance Verification Fails	7-25
7.5.10	Internal Calibration Fails	7-26
7.5.11	Floppy Disk Drive Option Fails	7-27
7.5.12	Graphic Printer Option Fails	7-28
7.5.13	Centronics Option Fails	7-29
7.6	Calibration Procedures	7-30
7.6.1	93XX-PS1715 Power Supply Calibration	7-30
7.6.1.1	Figure 7.8 : Power Supply Adjustment	7-31
7.6.2	93XX-Display Adjustment Procedure	7-32
7.6.2.1	Introduction	7-32
7.6.2.2	Coarse Adjustment	7-33
7.6.2.3	Fine Adjustment	7-34
7.6.3	Front End Test and Calibration Procedure	7-36
7.6.3.1	Introduction	7-36
7.6.3.2	Power Supplies	7-36
7.6.3.2.1	Front End Power Supply Verification	7-36
7.6.3.2.2	Probe Bus Power Supply Verification	7-36
7.6.3.2.3	ADC Power Supply Verification	7-37
7.6.3.3	16 bit DAC Verification	7-37
	Figure 7.9 : 9314A/M/L Front End Adjustment	7-41
7.6.3.4	Input Buffer DC Gain Adjustment	7-42
7.6.3.4.1	Channel 1 DC Gain Adjustment	7-42
7.6.3.4.2	Channel 2 DC Gain Adjustment	7-43
7.6.3.4.3	Channel 3 DC Gain Adjustment	7-44
7.6.3.4.4	Channel 4 DC Gain Adjustment	7-45
7.6.3.5	Overshoot and Risetime Adjustment	7-46
7.6.3.5.1	Channel 1 Overshoot and Risetime Adjustment	7-46
7.6.3.5.2	Channel 2 Overshoot and Risetime Adjustment	7-48
7.6.3.5.3	Channel 3 Overshoot and Risetime Adjustment	7-50
7.6.3.5.4	Channel 4 Overshoot and Risetime Adjustment	7-52
7.6.3.6	Flatness Adjustment	7-54
7.6.3.6.1	Channel 1 HF Adjustment	7-54
7.6.3.6.2	Channel 2 HF Adjustment	7-56
7.6.3.6.3	Channel 3 HF Adjustment	7-58
7.6.3.6.4	Channel 4 HF Adjustment	7-60
7.6.3.7	Trigger Hysteresis Control	7-62
7.6.3.7.1	Channel Trigger Hysteresis Adjustment	7-62
7.6.3.7.2	External Trigger Hysteresis Control	7-63
7.6.3.8	Validate Hysteresis Control	7-63
7.6.3.8.1	Channel Validate Hysteresis Adjustment	7-63
7.6.3.8.2	External Trigger Hysteresis Control	7-64

Section 7	Maintenance	Page
7.6.3.9	DC 50Ω Overload Adjustment	7-65
7.6.3.9.1	Channel 1 DC 50Ω Overload Adjustment	7-65
7.6.3.9.2	Channel 2 DC 50Ω Overload Adjustment	7-66
7.6.3.9.3	Channel 3 DC 50Ω Overload Adjustment	7-67
7.6.3.9.4	Channel 4 DC 50Ω Overload Adjustment	7-68
Section 8	Schematics, Diagrams, Parts List	8-1
8.1.1	9314A Sub Assemblies	8-2
8.1.2	9314AM Sub Assemblies	8-2
8.1.3	9314AL Sub Assemblies	8-2
8.2	F9300-1-2 or F9314M-1 Processor Board Schematic	8-3
8.2.1	F9300-1-2 or F9314M-1 Processor Board Layout	8-10
8.2.2	F9300-1-2 or F9314M-1 Processor Board Parts List	8-13
8.3	F9314A/M/L-3 Main Board Schematic	8-17
8.3.1	F9314A/M/L-3 Microprocessor Control Schematic	8-19
8.3.2	F9314A/M/L-3 Front End Control Schematic	8-22
8.3.2.1	F9314A/M/L-3 Front End Power Supply Schematic	8-23
8.3.2.2	F9314A/M/L-3 Front End Channel 1 Schematic	8-24
8.3.2.3	F9314A/M/L-3 Front End Channel 2 Schematic	8-27
8.3.2.4	F9314A/M/L-3 Front End Channel 3 Schematic	8-30
8.3.2.5	F9314A/M/L-3 Front End Channel 4 Schematic	8-33
8.3.2.6	F9314A/M/L-3 Front End Trigger Schematic	8-36
8.3.2.5	F9314A/M/L-3 Front End Probe Calibrator Schematic	8-38
8.3.3	F9314A/M/L-3 ADC Control Schematic	8-39
8.3.3.1	F9314A/M/L-3 ADC Power Supply Schematic	8-42
8.3.3.2	F9314A/M/L-3 ADC Channel 1 Schematic	8-43
8.3.3.3	F9314A/M/L-3 ADC Channel 2 Schematic	8-45
8.3.3.4	F9314A/M/L-3 ADC Channel 3 Schematic	8-47
8.3.3.5	F9314A/M/L-3 ADC Channel 4 Schematic	8-49
8.3.4	F9314A/M/L-3 TimeBase Schematic	8-51
8.4	F9314A/M/L-3 Layout	8-59
8.4.1	F9314A/M/L-3 Microprocessor Control Layout	8-58
8.4.2	F9314A/M/L-3 Front End Layout	8-72
8.4.3	F9314A/M/L-3 Trigger & Probe Calibrator Layout	8-85
8.4.4	F9314A/M/L-3 ADC Control Layout	8-92
8.4.5	F9314A/M/L-3 ADC Channel 1 & Channel 2 Layout	8-97
8.4.6	F9314A/M/L-3 ADC Channel 3 & Channel 4 Layout	8-101
8.4.7	F9314A/M/L-3 TimeBase Layout	8-103
8.5	F9314A/M/L-3 Parts List	8-110
8.6	F9300-4 GPIB/RS232 Interface Schematic	8-138
8.6.1	F9300-4 GPIB/RS232 Interface Layout	8-139
8.6.2	F9300-4 GPIB/RS232 Interface Parts List	8-142
8.7	F9314A-5 Front Panel Schematic	8-144
8.7.1	F9314A-5 Front Panel Layout	8-146
8.7.2	F9314A-5 Front Panel Parts List	8-150
8.8	F9300-6 Centronics Interface Schematic	8-152
8.8.1	F9300-6 Centronics Interface Layout	8-154

Section 8	Schematics, Diagrams, Parts List	Page
8.8.2	F9300-6 Centronics Interface Parts List	8-157
8.9	F9300-7 Printer Controller Schematic	8-159
8.9.1	F9300-7 Printer Controller Layout	8-161
8.9.2	F9300-7 Printer Controller Parts List	8-164
8.10.1	93XX-Deflection Schematic	8-167
8.10.2	93XX-Video Schematic	8-169
8.10.3	93XX-Deflection Parts List	8-170
8.10.4	93XX-Video Parts List	8-171
8.11	93XX-PS1715 Power Supply Schematic	8-172
8.12	M93XXA Mechanical for 9314A/M/L	8-174
8.13	Accessories for 9314A/M/L	8-175
8.14	93XX-FDGP Option Parts List	8-176
8.15	93XX-FD01 Option	8-177
8.16	93XX-GP01 Option	8-178
Section 9	Mechanical Parts	
9.1	Figure 9.1 : 9314A/M/L Exploded View	9-2
9.1.1	9314A/M/L Assembly Part Description	9-3
9.2	Figure 9.2 : 9314A/M/L Lower Cover Exploded View	9-4
9.2.1	9314A/M/L Lower Cover Assembly Description	9-5
9.3	Figure 9.3 : Front Frame Assembly Exploded View	9-6
9.3.1	Front Panel Assembly Description	9-7
9.4	Figure 9.4 : Rear Panel Assembly Exploded View (ECO1000)	9-8
9.4.1	Rear Panel Assembly Description (ECO1000)	9-9
9.4.2	Figure 9.5 : Rear Panel Assembly Exploded View (ECO1001)	9-10
9.4.3	Rear Panel Assembly Description (ECO1001)	9-11
9.5	Figure 9.6 : 93XX-PS1715 Power Supply Exploded View	9-12
9.5.1	93XX-PS1715 Power Supply Description	9-13
9.6	Figure 9.7 : FD01 Floppy Option Assembly	9-14
9.6.1	FD01 Floppy Option Assembly Description	9-15
9.7	Figure 9.8 : GP01 Printer Option Assembly	9-16
9.7.1	GP01 Printer Option Assembly Description	9-17
9.8	Figure 9.9 : 9314A/M/L Front View	9-18
9.9	Figure 9.10 : 9314A/M/L Rear View	9-19
9.10	Figure 9.11 : 9314A/M/L Dimensions	9-20
Section 10	Connecting the 9314A/M/L to a Plotter or a Printer	
10.1	Introduction	10-1
10.2	Plotters	10-3
10.2.1	HP 7470A Plotter	10-3
10.2.2	HP 7550A Plotter	10-3
10.2.3	Hitachi 672 Graph Plotter (or NSA 672)	10-4
10.3	Printers	10-4
10.3.1	Centronics Printers	10-4
10.3.2	RS 232 Printers	10-5
10.3.2.1	Epson FX80	10-5

Section 10	Connecting the 9314A/M/L to a Plotter or a Printer	Page
10.3.2.2	Citizen 120D	10-5
10.3.2.3	HP LaserJet	10-5
10.3.2.4	HP QuietJet	10-5
10.3.2.5	HP ThinkJet	10-6
10.3.2.6	HP DeskJet	10-6
10.3.2.7	Brother Printers	10-6
10.3.3	GPIB Printers	10-7
10.3.3.1	HP QuietJet	10-7
10.3.3.2	HP ThinkJet	10-7
10.3.3.3	HP PaintJet	10-7
10.4	Information on GPIB	10-8
10.4.1	Introduction	10-8
10.4.2	Functions in the GPIB	10-8

SECTION 1 GENERAL INFORMATION

1.1 Initial Inspection

It is recommended that the shipment be thoroughly inspected immediately upon delivery to the purchaser. All material in the container should be checked against the enclosed Packing List. LeCroy cannot accept responsibility for shortages in comparison with the Packing List unless notified promptly. If the shipment is damaged in any way, please contact the Customer Service Department or local field office immediately.

1.2 Warranty

LeCroy warrants its oscilloscope products to operate within specifications under normal use for a period of two years from date of shipment. Spares, replacement parts and repairs are warranted for 90 days. The instrument's firmware is thoroughly tested and thought to be functional, but is supplied "as is" with no warranty of any kind covering detailed performance. Products not manufactured by LeCroy are covered solely by the warranty of the original equipment manufacturer.

In exercising this warranty, LeCroy will repair or, at its option, replace any product returned to the Customer Service Department or an authorized service facility within the warranty period, provided that the warrantor's examination discloses that the product is defective due to workmanship or materials and that the defect has not been caused by misuse, neglect, accident or abnormal conditions or operation.

LeCroy will return all in-warranty products with transportation prepaid.

This warranty is in lieu of all other warranties, expressed or implied, including but not limited to any implied warranty of merchantability, fitness, or adequacy for any particular purpose or use. LeCroy shall not be liable for any special, incidental, or consequential damages, whether in contract or otherwise.

1.3 Product Assistance

Answers to questions concerning installation, calibration, and use of LeCroy equipment are available from the Customer Service Department, 700 Chestnut Ridge Road, Chestnut Ridge, New York 10977-6499, U.S.A., tel: (914) 578-6060, or 6061, and 2 rue du Pré-de-la-Fontaine, 1217 Meyrin 1, Geneva, Switzerland, tel : (41) 22.719.21.11, or your local field engineering office.

1.4 Addresses**Corporate Headquarters**

LECROY CORPORATION
700 CHESTNUT RIDGE ROAD
CHESTNUT RIDGE, NY 10977-6499
USA

TEL: (914) 425-2000 578-6060 or 6061
FAX: (914) 425-8967

European Headquarters

LECROY SA
2, CHEMIN PRE-DE-LAFONTAINE
CH-1217 MEYRIN 1 GENEVA
SWITZERLAND

TEL: 41 (22) 719-21-11
FAX: 41 (22) 782-39-15

Europe

LECROY GMBH
MANNHEIMERSTRASSE 177
POSTFACH 103767
D-6900 HEIDELBERG GERMANY

TEL: 49.6221.831001
FAX: 49.6221.834655

LECROY LTD
28 BLACKLANDS WAY
ABINGDON, OXON OX14 1DY
GREAT BRITAIN

TEL: 44.23.553.31.14
FAX: 44.23.552.87.96

LECROY SRL
VIA CONCESIO 325
I-00188 ROMA
ITALY

TEL: 39.6.300.97.00
FAX: 39.6.300.96.00

ESSA
EUIPOS Y SISTEMAS SA
APOLONIO MORALES 13-B
E-28036 MADRID

TEL: 34.1.359.0088
FAX: 34.1.359.0298

DEWETRON ELEKTRONISCHE
MESSGERAETE Ges.M.B.H.
FOELLINGERSTRASSE 9E
8044 GRAZ AUSTRIA

TEL: 43.316.391.804
FAX: 43.316.391.052

ORBIS OY
VANHA KAARELANTIE 9
01610 VANTAA
FINLAND

TEL: 358.0.566.4066
FAX: 358.0.531.604

LECROY BV
WAALRESEWEG 17
NL-5554 HA VALKENSWAARD
THE NETHERLANDS

TEL: 31.4902.8.9285
FAX: 31.4902.42628

LECROY SARL
AVENUE DU PARANA
F-91941 LES ULIS CEDEX
FRANCE

TEL: 33.1.69.18.83.20
FAX: 33.1.69.07.40.42

LECROY SA
BAHNOFSTRASSE 18
5600 LENZBURG
SWITZERLAND

TEL: 4164.519.181
FAX: 4164.519.192

M.T. BRANDAO, LDA
RUA DO QUANZA, 150
4000 PORTO
PORTUGAL

TEL: 351.2.815.680
FAX: 351.2.815.630

LUTRONIC APS
NAVERLAND 2
2600 GLOSTRUP
DENMARK

TEL: 45.4342.9764
FAX: 45.4342.9765

HELLENIC SCIENTIFIC REP., LTD
11 VRASSIDA STREET
115 28 ATHENS
GREECE

TEL: 30.1.721.1140 or 721.3154
FAX: 30.1.724.1374

AVANTEC
TVETENVEIEN 6
0661 OSLO NORWAY

TEL: 472.63.05.20
FAX: 472.65.84.14

ABB NERA A/S
KOKSTADVEGEN 23
KOKSTAD BERGEN NORWAY

TEL: 351.2.815.680
FAX: 351.2.815.630

MEASUREMENT SYSTEMS SCANDINAVIA AB
P.O. BOX 393 FORETAGSALLEN 12, HUS 5 BV
184 24 AKERSBERGA SWEDEN

TEL: 46.8.540.68100
FAX: 46.8.540.66536

Eastern Europe

ELSINCO GMBH
ROTENMUEHLGASSE 11
1120 VIENNA
AUSTRIA

TEL: 43.222.812.1751
FAX: 43.222.812.2329

Mideast

AMMO
9, HARUGEI MALKHUT
RAMAT HACHAYAL. P.O BOX 13132,
61131 TEL AVIV ISRAEL

TEL: 972.3.6478740
FAX: 972.3.6478771

Asia

LECROY JAPAN CORPORATION
ESAKA SANSHO BLDG - 3RD FLOOR
16-3, 3-CHOME
TARUMICHO, SUITA CITY
OSAKA 564 JAPAN

TEL: 816.330.0961
FAX: 816.330.8096

LECROY JAPAN CORPORATION
ZAIKEN BLDG 6TH FLOOR
19-3, 2-CHOME
SASAZUKA, SHIBUYA-KU
TOKYO 151 JAPAN

TEL: 813.3376-9400
FAX: 813.3376.9587

SCIENTIFIC DEVICES AUSTRALIA
2 JACKS ROAD
SOUTH OAKLEIGH, VICTORIA
AUSTRALIA

TEL: 61.3579.3622
FAX: 61.3579.0971

TATA-HONEYWELL
55-A/8 & 9 HADAPSPAR
INDUSTRIAL ESTATE
PUNE 411 013 INDIA

TEL: 91.212.670445
FAX: 91.212.672205

E.C. GOUGH, LTD
245 ST.ASAPH STREET
P.O. BOX 22073
CHRISTCHURCH NEW ZEALAND

TEL: 64.3.3798.740
FAX: 64.3.3796.776

ELECTRO TECH CORPORATION
1ST FLOOR, 16 KAZI CHAMBERS
BAHADURSHAH ZAFAR ROAD
KARACHI-74800 PAKISTAN

TEL: 92.21.493-8087
FAX: 92.21.493-7749

SINGAPORE ELECTRONICS
AND ENGINEERING, LTD
24 ANG MO KIO STREET, 65
SINGAPORE 2056

TEL: 65.480.7783
FAX: 65.481.4272

LECOLN TECHNOLOGY CO.,LTD.
4F-1, NO. 214, SEC.1
HO PING E ROAD
TAIPEI TAIWAN R.O.C.

TEL: 886.2.365.0612
FAX: 886.2.367.1792

SCHMIDT ELECTRONICS LTD
18 F, GREAT EAGLE CENTRE
23 HARBOUR ROAD WANCHAI
HONG KONG

TEL: 8.52.827.5656
FAX: 8.52.505.0222

P.T. DWI TUNGGAL JAYA SAKTI
WISMA RAJAWALI, 14TH FLOOR
JL JENDRAL SUDIRMAN
34 JAKARTA 10220INDONESIA

TEL: 62.21.570.4563
FAX: 62.21.583.218

North America

ALLAN CRAWFORD LTD
5835 COOPERS AV, MISSISSAUGA
ONTARIO L4Z 1Y2, CANADA

TEL: 416 890.2010
FAX: 416 890.1959

South America

SEARCH SA
VIAMONTE 1716 - PISO 7
1055 CAPITAL FEDERAL
ARGENTINA

TEL: 54.1.46.6156
FAX: 54.1.394.8374

ABEX ENGINEERING PTE. LTD.
37 KALLANG PUDDING ROAD 08-08
TONG LEE BUILDING BLOCK B
SINGAPORE 1334

TEL: 8412818
FAX: 8415988

MEASURETRONIX
2102/31 RAMKAMHANG ROAD
BANGKOK 10240
THAILAND

TEL: 66.2.375.2733-4
FAX: 66.2.374.9965

WOOJOO HI-TECH CORP.
DONGHYUN BLDG.
102-4 MOONJUNG-DONG,
SONGPA-KU SEOUL 138-200 KOREA

TEL: 82.2.449.5472
FAX: 82.2.449.5475

ATP-HI-TEK
ALAMEDA AMAZONAS
422 ALPHAVILLE 06454-030
BARUEI, SP BRAZIL

TEL: 55.11.421.5477
FAX: 55.11.421.5032

Central America

NUCLEOELECTRONICA, SA
CALZ. LAS AGUILAS 101
DELEGACION ALVARO OBREGON
01710 MEXICO, 20, d.f.
MEXICO

TEL: 52.5593.604
FAX: 52.5593.6021

South Africa

WESTPLEX LTD
TUSCANY HOUSE
376 OAK AVENUE
RANDBURG 2194
REPUBLIC OF SOUTH AFRICA

TEL: 27.11.787.0473
FAX: 27.11.787.0237

1.5 Maintenance Agreements

LeCroy offers a selection of customer support services. Maintenance agreements provide extended warranty and allow the customer to budget maintenance costs after the initial two year warranty has expired. Other services such as installation, training, enhancements and on-site repair are available through specific Supplemental Support Agreements.

1.6 Documentation Discrepancies

LeCroy is committed to providing state-of-the-art instrumentation and is continually refining and improving the performance of its products. While physical modifications can be implemented quite rapidly, the corrected documentation frequently requires more time to produce. Consequently, this manual may not agree in every detail with the accompanying product. There may be small discrepancies in the values of components for the purposes of pulse shape, timing, offset, etc., and, occasionally, minor logic changes. Where any such inconsistencies exist, please be assured that the unit is correct and incorporates the most up-to-date circuitry. In a similar way the firmware may undergo revision when the instrument is serviced. Should this be the case, manual updates will be made available as necessary.

1.7 Service Procedure

Products requiring maintenance should be returned to the Customer Service Department or authorized service facility. LeCroy will repair or replace any product under warranty at no charge. The purchaser is only responsible for one way transportation charges. For all LeCroy products in need of repair after the warranty period, the customer must provide a Purchase Order Number before repairs can be initiated. The customer will be billed for parts and labor for the repair, as well as for shipping.

1.8 Return Procedure

To determine your nearest authorized service facility, contact the Customer Service Department or your field office. All products returned for repair should be identified by the model and serial numbers and include a description of the defect or failure, name and phone number of the user, and, in the case of products returned to the factory, a Return Authorization Number (RAN). The RAN may be obtained by contacting the customer service department in New York, tel: (914)578-6060, or 6061 ; in Geneva, tel: (41)22/719.21.11, or your nearest sales office.

Return shipment should be made prepaid. LeCroy will not accept C.O.D. or Collect Return Shipments. Air-freight is generally recommended. Wherever possible, the original shipping carton should be used. If a substitute carton is used, it should be rigid and be packed such that the product is surrounded with a minimum of four inches of excelsior or similar shock-absorbing material. In addressing the shipment, it is important that the Return Authorization Number be displayed on the outside of the container to ensure its prompt routing to the proper department within LeCroy.

1.9 Safety Precautions

The following servicing instructions are for use by qualified personnel only. Do not perform any servicing other than contained in service instructions. Refer to procedures prior to performing any service.

Exercise extreme safety when testing high energy power circuits. Always turn the power OFF, disconnect the power cord, discharge the cathode ray tube and all capacitors before disassembling the instrument.

The **WARNING** symbol used in this manual indicates dangers that could result in personal injury.

The **CAUTION** symbol used in this manual identify conditions or practices that could damage the instrument.

1.10 Antistatic Precautions

CAUTION

Any static charge that builds on your person or clothing may be sufficient to destroy CMOS components, integrated circuits.

In order to avoid possible damage, the usual precautions against static electricity are required.

- Handle the boards in antistatic boxes or containers with foam specially designed to prevent static build-up.
- Ground yourself with a suitable wrist strap.
- Disassembly the instrument at a properly grounded work station equipped with antistatic mat.
- When handling the boards, do not touch the pins.
- Stock the boards in antistatic bags.

SECTION 2 SPECIFICATIONS

9314A, 9314AM & 9314AL Digital Oscilloscope

9310A Family Digital Oscilloscopes

400 MHz Bandwidth, 100 MS/s

Main Features

- Two and Four Channel Versions
- 50k, 200k and 1M Point Records
- LeCroy ProBus™ Probe System
- Glitch, Window, Qualified, Interval, Dropout and TV Triggers
- 8-bit vertical resolution, 11 with ERES option
- Fully Programmable via GPIB and RS-232-C
- Automatic PASS/FAIL testing
- Persistence, XY and Roll Modes
- Advanced Signal Processing
- DOS Compatible Floppy Disk and Memory Card Options
- Internal Printer Option



The 9310A family forms a range of ideal general-purpose digital oscilloscopes. They capture single-shot events at up to 100 MSamples/s, and repetitive signals at 10 GSamples/s. Record lengths up to 1M points provide high-quality horizontal resolution, and allow fast digitizing of long-duration events. Memories can be segmented, for minimum dead time between acquisitions.

Live waveforms may be viewed simultaneously with up to 3 expansions, showing all of the signal detail. Expansions are shown as highlights on the main trace.

The LeCroy ProBus™ intelligent probe system allows automatic sensing of the probe type. For LeCroy's active FET

probes it also provides variable offset at the probe tip; offset and coupling are controlled from the scope front panel.

SMART Trigger modes like Glitch, Window and Dropout allow you to capture precisely the events of interest. A comprehensive range of signal processing functions, on live or stored waveforms, allows waveform manipulation without destroying the underlying data.

The 9310A family features the proven user-interface of LeCroy's portable scope family. A bright, high-resolution 9" CRT allows optimum waveform viewing under any conditions. Menus and text are arranged around the graticules - they never overwrite the waveforms.

Each of the main control functions has a dedicated single knob, to keep the scope's performance at your fingertips.

DOS compatible floppy disk and memory card options store waveforms and test setups, and make transferring data to a PC easier than ever before. Hardcopies may be made on GPIB, RS-232-C or Centronics printers or plotters. An optional internal printer is also available.

Optional packages provide extensive Waveform Processing including FFT and Enhanced Resolution to 11 bits.

Features and Benefits

PRECISION ACQUISITION

The 9310A family combines all the technologies required for accurate waveform digitizing. Low-noise high-sensitivity amplifiers drive 8-bit ADC's which are clocked simultaneously by a high-precision timebase. Vertical resolution can be extended as high as 12 bits using averaging techniques. All these features are combined with a genuine 2 millivolt sensitivity setting and a big, crisp display to let you see the finest signal details.

MEMORY FOR ALL APPLICATIONS

These oscilloscopes are available in three different memory lengths: 50k points per channel (std. versions), 200k points per channel ("M" versions), 1M points per channel ("L" versions). Long memories provide higher horizontal resolution, and LeCroy's unique memory management system maximizes the benefits of longer memory. Showing the entire waveform onscreen allows immediate location of glitches or other disturbances, and guarantees the highest possible sample rate on all timebases.

EXTENSIVE TRIGGER SYSTEM

In normal operation, the instrument triggers just like an analog oscilloscope. To capture rare or complex conditions, SMART trigger functions are available. These include Glitch trigger down to 2.5 ns and a unique Dropout mode, which causes a trigger to occur when the signal disappears for a selectable period of time. Other trigger modes like Bislope Window, Interval, State- or Edge-Qualified are also available. TV trigger allows individual lines or fields in PAL, SECAM, NTSC and non-standard video to be selected. Pre- and Post-trigger delay are fully variable. Trigger icons show the trigger setup at a glance.

ProBus™ PROBE INTERFACE

The ProBus system provides a complete measurement solution from probe tip to oscilloscope display. ProBus is an intelligent interconnection between LeCroy oscilloscopes and a growing range of innovative probes. ProBus provides automatic sensing of the probe type. For LeCroy's FET probes, it also allows offset at the probe tip and coupling to be controlled from the scope front panel.

AUTOMATIC MEASUREMENTS

The following Parametric measurements are available, together with their Average, Highest, Lowest values and Standard Deviation:

amplitude	falltime	peak to peak
area	f 80-20%	period
base	f@level (abs)	risetime
cycles	f@level (%)	r 20-80%
delay	frequency	r@level (abs)
Δdelay	maximum	r@level (%)
Δt at level (abs)	mean	RMS
Δt at level (%)	median	std dev
Δt at level (t=0,abs)	minimum	top
Δt at level (t=0,%)	overshoot +	width
duty Cycle	overshoot -	

Pass/Fail testing allows up to 5 parameters to be tested against selectable thresholds. Waveform Limit Testing is performed using Masks which may be defined inside the instrument. Any failure will cause preprogrammed actions such as Hardcopy, Save, GPIB SRQ or Pulse Out.

DOS COMPATIBLE MASS STORAGE

All LeCroy 9300-series scopes offer an optional 3.5" 1.44 MB floppy disk drive which stores traces, setups, screen graphics and Pass/Fail templates. Data are stored as DOS files, which may be read directly by a PC. A high-speed DOS compatible PCMCIA memory card option is also available.

BUILT-IN PRINTER

As well as driving most printers and plotters via GPIB, RS-232-C and (optional) Centronics interface, the 9300 series offers an optional internal printer. This thermal printer produces full resolution screendumps, 126 x 90 mm, in under 10 seconds.

FLEXIBLE INTERFACING

GPIB and RS-232-C interfaces may be used for full remote control of the instrument. All front-panel and internal processing functions can be controlled via either interface. For applications where throughput is essential, the GPIB interface transfers hundreds of waveforms per second. A Front-Panel BNC connector may be setup to provide Pass/Fail test output pulses.

MULTIPLE DISPLAY MODES

The high-resolution raster display shows from one to four independent waveform grids. Waveforms are represented as dots joined by vectors which may be turned on or off. Four Zoom/Math traces may be used for zooming waveforms or for signal processing. The area to be zoomed is selected by moving an intensified portion of the main waveform. Persistence display mode allows easy viewing of signal changes over time, and XY mode plots any two sources against one another. Cursors are usable in all display modes.

EXTENSIVE WAVEFORM MATH

Standard built-in waveform processing includes mathematics (Add, Subtract, Multiply and Divide, Negation and Identity) and Summation Averaging (up to 1000 sweeps). Option WP01 provides Summed and Continuous Averaging, Waveform Math Functions, Extrema and Enhanced Resolution Modes. More information is available in the 9300 WP01 datasheet.

OPTIONAL FFT PACKAGE

Option WP02 provides comprehensive Spectral Analysis capabilities, permitting the system designer to identify characteristics which may not be apparent in the time domain. WP02 provides a wide selection of displayed projections and windowing functions, as well as averaging in the frequency domain. For more information, see the 9300 WP02 datasheet.

9310A Family Specifications

ACQUISITION SYSTEM

Bandwidth (-3 dB)

@ 50 Ω: DC to 400 MHz
 Below 200 mV/div: 350 MHz
 At 2mV/div: 300 MHz

@ 1 MΩ DC: DC to 250 MHz typ. at the probe tip.

No. of Channels: 4 (9314A) or 2 (9310A)

No. of Digitizers: 4 (9314A) or 2 (9310A)

Maximum Sample Rate: 100 MS/s simultaneously on each channel.

Acquisition memories, per channel:

9310A-9314A 50k
 9310AM-9314AM 200k
 9310AL-9314AL 1M

Sensitivity: 2 mV/div to 5 V/div, fully variable.

Scale factors: A vast choice of probe attenuation factors are selectable.

Offset Range: 2.0 - 9.9 mV/div: ± 120 mV
 10 - 199 mV/div: ± 1.2 V
 0.2 - 5.0 V/div: ± 24 V

DC Accuracy: ≤ ± 2% full scale (8 divisions) at 0 V offset.

Vertical Resolution: 8 bits.

Bandwidth Limiter: 30 MHz.

Input Coupling: AC, DC, GND.

Input Impedance: 1 MΩ/15 pF or 50Ω ± 1%.

Max Input:

1 MΩ: 250 V (DC+peak AC ≤ 10 kHz)
 50 Ω: ± 5 V DC (500 mW) or 5 V RMS

TIME BASE SYSTEM

Timebases: Main and up to 4 Zoom Traces.

Time/Div Range: 1 ns/div to 1000 s/div.

Clock Accuracy: ≤ ± 0.002 %.

Interpolator resolution: 10 ps.

Roll Mode: Ranges 500 ms to 1,000 s/div.

For > 50k points: 10 s to 1,000 s/div.

External Clock: ≤ 100 MHz on EXT input with ECL, TTL or zero crossing levels.

TRIGGERING SYSTEM

Trigger Modes: Normal, Auto, Single, Stop.

Trigger Sources: CH1, CH2, Line, Ext, Ext/10 (9314A: CH3, CH4). Slope, Level and Coupling for each can be set independently.

Slope: Positive, Negative, Window (BiSlope).

Coupling: AC, DC, HF (up to 500 MHz), LFREJ, HFREJ.

Pre-trigger recording: 0 to 100% of full scale (adjustable in 1% div increments).

Post-trigger delay: 0 to 10,000 divisions (adjustable in 0.1 div increments).

Holdoff by time: 10 ns to 20 s.

Holdoff by events: 0 to 99,999,999 events.

Internal Trigger Sensitivity Range: ± 5 div.

EXT Trigger Max. Input:

1 MΩ/15 pF: 250 V (DC+peak AC ≤ 10 kHz)
 50 Ω ± 1%: ± 5 V DC (500 mW) or 5 V RMS
EXT Trigger Range: ± 0.5V (± 5V with Ext/10).

Trigger Timing: Trigger Date and Time are listed in the Memory Status Menu.

SMART TRIGGER TYPES

Signal Width: Trigger on width between two limits selectable from 2.5ns to 20s.

Signal Interval: Trigger on interval between two limits selectable from 10ns to 20s.

Dropout: Trigger if the input signal drops out for longer than a time-out from 25ns to 20s.

State/Edge Qualified: Trigger on any source only if a given state (or transition) has occurred on another source. The delay between these events can be defined as a number of events on the trigger channel or as a time interval.

TV: Allows selection of both line (up to 1500) and field number (up to 8) for PAL, SECAM, NTSC or non-standard video.

ACQUISITION MODES

Random Interleaved Sampling (RIS):

for repetitive signals from 1 ns/div to 10 μs/div.

Single shot: for transient and repetitive signals from 50 ns/div.

Sequence: Stores multiple events in segmented acquisition memories.

Number of segments available:

9310A-9314A 2-200
 9310AM-9314AM 2-500
 9310AL-9314AL 2-2,000

Dead Time between segments: ≤ 150 μs

DISPLAY

Waveform style: Vectors connect the individual sample points, which are highlighted as dots. Vectors may be switched off.

CRT: 12.5 x 17.5 cm (9" diagonal) raster.

Resolution: 810 x 696 points.

Modes: Normal, X-Y, Variable or Infinite Persistence.

Real-time Clock: Date, hours, minutes, seconds.

Graticules: Internally generated; separate intensity control for grids and waveforms.

Grids: 1, 2 or 4 grids.

Formats: YT, XY, and both together.

Vertical Zoom: Up to 5x Vertical Expansion (50x with averaging, up to 40 μV sensitivity).

Horizontal Zoom Factors:

9310A-9314A 1000x
 9310AM-9314AM 5,000x
 9310AL-9314AL 20,000x

Waveforms can be expanded to give 4-5 points/division. This implies zoom factors up to 20,000x for the 9314AL.

INTERNAL MEMORY

Waveform Memory: Up to four 16-bit Memories (M1, M2, M3, M4).

Processing Memory: Up to four 16-bit Waveform Processing Memories (A, B, C, D).

Setup Memory: Four non-volatile memories. Optional Cards or Disks may also be used for high-capacity waveform and setup storage.

CURSOR MEASUREMENTS

Relative Time: Two cursors provide time measurements with resolution of ± 0.05% full-scale for unexpanded traces; up to 10% of the sampling interval for expanded traces. The corresponding frequency value is displayed.

Relative Voltage: Two horizontal bars measure voltage differences up to ± 0.2% of full-scale in single-grid mode.

Absolute Time: A cross-hair marker measures time relative to the trigger and voltage with respect to ground.

	9310A	9310AM	9310AL	9314A	9314AM	9314AL
Number of Channels	2			4		
Acquisition Memory per Channel	50k	200k	1M	50k	200k	1M

WAVEFORM PROCESSING

Up to four processing functions may be performed simultaneously. Functions available are: Add, Subtract, Multiply, Divide, Negate, Identity and Summation Averaging.

Average: Summed averaging of up to 1,000 waveforms in the basic instrument. Up to 10^6 averages are possible with Option WP01.

Envelope*: Max, Min, or Max and Min values of from 1 to 10^6 waveforms.

ERES*: Low-Pass digital filter provides up to 11 bits vertical resolution.

Sampled data is always available, even when trace is turned off. Any of the above modes can be invoked without destroying the data.

FFT*: Spectral Analysis with four windowing functions and FFT averaging.

*Envelope and ERES modes are provided in Math Package WP01. FFT is in WP02.

AUTOSETUP

Pressing Autosetup sets timebase, trigger and sensitivity to display a wide range of repetitive signals. (Amplitude 2mV to 40V; frequency above 50Hz; Duty cycle greater than 0.1%).

Autosetup Time: Approximately 2 seconds.

Vertical Find: Automatically sets sensitivity and offset.

PROBES

Model: One PP002 (10:1, 10 M Ω // 15 pF) probe supplied per channel.

The 9310A family is fully compatible with LeCroy's range of FET Probes, which may be purchased separately.

Probe calibration: Max 1 V into 1 M Ω .

500 mV into 50 Ω , frequency and amplitude programmable, pulse or square wave selectable, rise and fall time 1 ns typical.

Alternatively, the Calibrator output can provide a trigger output or a PASS/FAIL test output.

INTERFACING

Remote Control: Of all front-panel controls, as well as all internal functions is possible by GPIB and RS-232-C.

RS-232-C Port: Asynchronous up to 19200 baud for computer/terminal control or printer/plotter connection.

GPIB Port: (IEEE-488.1) Configurable as talker/listener for computer control and fast data transfer. Command Language complies with requirements of IEEE-488.2.

Centronics Port: Optional hardcopy parallel interface.

Hardcopy: Screen dumps are activated by a front-panel button or via remote control. TIFF and BMP formats are available for importing to Desktop Publishing programs. The following printers and plotters can be used to make hardcopies: HP DeskJet (color or BW), HP ThinkJet, QuietJet, LaserJet, PaintJet and EPSON printers. HP 7400 and 7500 series, or HPGL compatible plotters. An optional internal printer is also available.

GENERAL

Auto-calibration ensures specified DC and timing accuracy.

Temperature: 5° to 40° C (41° to 104° F) rated 0° to 50° C (32° to 122° F) operating.

Humidity: <80%.

Shock & Vibration: Meets MIL-STD-810C modified to LeCroy design specifications and MIL-T-28800C.

Power: 90-250 V AC, 45-66 Hz, 150 W.

Battery Backup: Front-panel settings maintained for two years.

Dimensions: (HWD) 8.5"x14.5"x16.25", 210mm x 370mm x 410mm.

Weight: 12.5kg (27.5lbs) net, 18kg (40lbs) shipping.

Warranty: Two years.

Ordering Information**Oscilloscope and Options**

9310A/AM/AL	Digital Oscilloscope
9314A/AM/AL	Digital Oscilloscope
9XXX-WP01	Waveform Math
9XXX-WP02	FFT Processing
9XXX-MC01/04	Memory Card Reader w/512KB Memory Card
93XX-FD	Internal 3.5" Floppy Drive
93XX-GP	Internal Graphics Printer

Oscilloscope Accessories**Supplied with Instrument:**

931X-OM	Operator's Manual
93XX-RCM	Remote Control Manual
93XX-FC	Front Cover
PP002	350MHz, 10M Ω Passive Probe (1 per channel)

Ordered separately:

93XX-W5	5 years extended warranty
93XX-CC	Calibration Certificate
931XA-SM	Service Manual
9XXX-MC02	128K Memory Card
9XXX-MC04	512K Memory Card
DC/GPIB-2	2 Meter GPIB Cable
SG9001	High Voltage Protector
OC9001	Oscilloscope Cart
AP020	1 GHz, 10:1 FET Probe
AP021	800 MHz, 5:1 FET Probe
AP030	15 MHz Differential Probe
P9011	10:1 / 1:1 Probe
PP012	100:1 Probe
PP062	1 GHz, 10:1, 500 Ω Passive Probe
PP090	ProBus 75 to 50 Ω adapter
93XX-RM01	Rackmount
93XX-TC1	Transit Case
93XX-TC2	Carrying Bag

USA Direct Sales: 1 (800) 5LE-CROY**LeCroy Worldwide Sales Offices**

ASIA/PACIFIC	LeCroy Pty Ltd	61.38.90.7358
BENELUX	LeCroy BV	04902.8.9285
FRANCE	LeCroy SARL	(1).69.18.83.20
GERMANY	LeCroy GmbH	06221 83.10.01
ITALY	LeCroy SRL	06.336.797.00
JAPAN Osaka	LeCroy Japan	0816.330.0961
JAPAN Tokyo	LeCroy Japan	0813.3376.9400
SWITZERLAND Geneva		022.719.21.11
SWITZERLAND Lenzburg		064.51.91.81
United Kingdom	LeCroy Ltd	(0235) 533114

Other sales and service representatives throughout the world.

LeCroy

The Digital Scope Specialists

9300 Series PCMCIA Hard Disk Adapter, Internal Printer, 3.5" Floppy Disk Drive and Ram Card

Main Features

- PCMCIA Type III compatible Hard Disk Adapter, DOS Compatible
- High-resolution Printer, ideal for fast, on-the-spot documentation
- 3.5" Floppy disk drive, DOS format - affordable and convenient
- Ultra-fast RAM card, DOS format, ideal for PASS/FAIL testing
- Convenient Hardcopy storage to card/disk



3.5" Floppy

The floppy drive is a convenient storage medium, not only for saving and retrieving waveforms or instrument settings, but also for storing hardcopies that can be printed from a PC when desired. The floppy supports both 720k and 1.44M DOS formats so that it can be read back on any PC with a 3.5" drive, avoiding the need to interface the oscilloscope to your PC. As with the RAM-card option, the floppy system capabilities include automatic storage of data under pre-programmed conditions.

PCMCIA Storage

PCMCIA Interfaces for RAM card and Hard Disk allow the use of fast, removable and compact storage media for saving and retrieving waveforms and instrument settings. They comply fully with the PC industry's PCMCIA and JEIDA standards. With the special Autostore feature, waveforms can be automatically stored after every acquisition and "played back" when desired. When used in combination with the PASS/FAIL feature, failure data can be saved automatically for later analysis.

Printer

The internal printer is an invaluable tool for instant, on-the-spot documentation. It generates a clear, crisp hardcopy of the screen in just a few seconds. The large size of the printout, combined with its high resolution, provide you with an excellent document that matches the screen's superior quality to its finest details. And because it frees you from the trouble of carrying and interfacing a bulky printer, it is the ideal solution for field measurements.

Mass Storage Features and Benefits

LeCroy's mass storage capabilities provide a range of benefits:

- Easy data transfers to PCs
- Waveform logging
- Waveform archiving for future use
- Faster troubleshooting
- Faster, more reproducible testing
- Shared oscilloscope resources

EASY DATA TRANSFER TO PC

Because the 9300 series oscilloscope uses DOS-formatted floppy disks, hard disks and memory cards, transferring waveform data to a PC is simple. The removable storage allows transfers without cables, programming, or any knowledge of GPIB, RS-232, or other interfaces.

In addition, LeCroy provides free of charge, a binary-to-ASCII format conversion program for the PC, accommodating those PC-based analysis packages (such as spreadsheets) that require ASCII format.

WAVEFORM LOGGING

By using Glitch or Dropout triggering in combination with the powerful AUTO-STORE mode, LeCroy oscilloscopes can monitor and log intermittent problems automatically. To store a waveform, the oscilloscope opens and names a DOS-compatible file and then stores the waveform data in the file. This logging feature requires no operator intervention and maintains data and the operational setup through power line failures. Logged waveforms can be selectively played back by trigger time/date or by sequence number, or can be scrolled through sequentially.

WAVEFORM ARCHIVING FOR FUTURE USE

- Recallable proof of performance
- Additional data analysis as needed
- Accurate trend or drift monitoring
- Calibration procedure verification

When storing waveforms, LeCroy DSOs also archive a header of setup information and the acquisition time/date. After recalling an archived waveform, the several hundred byte header ensures correct time and voltage scaling. When recalled into the oscilloscope, the waveform can be zoom expanded,

compared, or analyzed just like a live waveform. The time/date offers proof of measurement authenticity and trend sequence.

All LeCroy DSOs store raw waveform data using one byte per sample point. Signal averaged, Enhanced Resolution (ERES) filtered, and other processed data use two bytes per point, to take advantage of the added resolution.

HARDCOPY ARCHIVING

Hardcopies of the screen can also be stored for future use. For instance, a screen saved in TIFF format can be imported into a Word Processor to illustrate a report. Additionally, field-measurement screens can be saved in LaserJet format on the memory card or floppy disk, and then printed from a PC back in the lab.

FASTER FIELD MEASUREMENTS

Recallable reference waveforms and oscilloscope setups for each test point on a Device Under Test (DUT) can make fault troubleshooting faster and more accurate. A dedicated memory card or floppy disk will hold all of the correct test point waveforms and associated DSO setups for a particular DUT.

The technician can recall stored setups quickly and consistently, thereby avoiding incorrect measurement conditions. He can then compare actual waveforms to recalled reference waveforms taken from a known working system. He will therefore spend less time probing a large number of test points and verifying that the correct waveforms exist.

If a problem is found, the aberrant waveform may be saved. It can later be shown to laboratory-based engineers, for example, for problem-solving guidance or for improvement of DUT design.

Memory cards - rugged and pocket-sized - are ideal for this application.

FASTER, MORE REPRODUCIBLE TESTING

LeCroy oscilloscopes will compare measured waveforms against upper and lower waveshape tolerances or against parameter limits, such as risetime, overshoot, or peak voltage, and make PASS/FAIL decisions. This PASS/FAIL

testing decreases test times in GPIB-based ATE systems by reducing data transfers. It increases reproducibility and accuracy in manual tests by eliminating human errors. Once defined, these tests may be saved by storing instrument setups which include the specified tolerances and/or reference waveforms. Different test personnel can easily share a common test library via a PC network.

Waveshape test limits can be generated by capturing a "golden" waveform and by then selecting amplitude and timing limits (in fractions of screen graticule divisions). Or a user can create standard waveform limit templates on a computer (e.g. ANSI/CCITT telecommunication templates).

With the LeCroy 9300 series DSOs, specific parameter tolerance test procedures are created by selecting limits for any five out of twenty pulse parameters with Boolean AND / OR conditions between them. During testing, FAIL responses can include an audible beep, GPIB SRQ, hardcopy output, or store to memory card.

SHARED OSCILLOSCOPE RESOURCES

By plugging-in your *personal* floppy disk, RAM card or PCMCIA Hard Disk you can restore your setup in seconds. Individual users can keep preferred setups on separate disks or cards or within separate directories.

COPY FILES	
Direction	
<input checked="" type="checkbox"/>	Card -> Flpy
<input type="checkbox"/>	Flpy -> Card
<input type="checkbox"/>	Card -> HDD
<input type="checkbox"/>	HDD -> Card
Which Files	
<input type="checkbox"/>	Panels
<input type="checkbox"/>	Prints
<input type="checkbox"/>	Auto Wfms
<input type="checkbox"/>	Norm Wfms
<input checked="" type="checkbox"/>	All Files
DO COPY	
!OVERWRITES FILES WITH SAME NAME	

A selection of files can be copied between the available mass storage devices.

Hardcopy Features and Benefits

The internal printer adds a whole range of benefits to the LeCroy 9300 series:

- Ultra-fast printouts
- High resolution printing
- Easy transportation
- Trouble-free interfacing
- Auto Print on Trigger

ULTRA-FAST PRINTOUTS

Measurement documentation is made easier and faster since the internal printer produces a hardcopy in less than 10 seconds. In addition the document is date- and time-stamped: a real bonus for archiving test results.

HIGH RESOLUTION PRINTING

With a resolution of 190 dots-per-inch, the internal printer matches the screen's superior quality. And for even higher resolution, the printout can be stretched to a full 70 meter length so you can see those traces down to their finest details.

EASY TRANSPORTATION

A printer that is totally integrated in the instrument makes life much easier for field-measurement applications. Imagine carrying a scope, a printer (and perhaps a floppy drive) in one hand!

TROUBLE-FREE INTERFACING

The internal printer frees your mind from the struggle with cable schematics, baud rates, gender-changers and dip switches, for more productive tasks. Select the internal printer in the scope's utilities menu, hit the SCREEN DUMP button, and you're in business!

AUTO PRINT ON TRIGGER

The Auto Print feature is used to print a screen image on each acquisition.

The 9300 series oscilloscope supports a whole range of popular printers and plotters. Hardcopies can be either sent directly to the peripheral device or to the floppy disk, Ram Card or Hard disk for future use.



OTHER HARDCOPY SOLUTIONS

High quality project reports, presentation materials, technical manuals, and troubleshooting instructions often require integration of text and graphics on the same page.

Advanced PC desktop publishing and word processors such as Word-for-Windows, WordPerfect, or AMI Pro can directly import graphic files, size them, and position them anywhere on the page. Written text can then wrap around or be positioned within the graphics.

LeCroy 9300 oscilloscopes will save screens in TIFF (Tagged Image Format File), or BMP. After transferring the file to a PC, the DTP software can import and manipulate the document like any other graphic object.

The LeCroy 9300 series also offers a wide range of interfacing capabilities with external hardcopy devices:

- Plotters. HPGL, HP 7400 and 7500 compatible
- Printers. HP LaserJet, ThinkJet, Paintjet (including color), DeskJet (including color) and Epson
- Interfacing. RS-232, GPIB, or even Centronics (optional)

Specifications

MASS STORAGE

	Floppy Disk	Ram Card	Hard Disk
Compatibility	3.5" Floppy Drive	PCMCIA I, II JEIDA 3.0, 4.0	PCMCIA III
Supported Formats	DOS Format	Read/Write: SRAM Read: OTP, ROM, Flash DOS Format	DOS Format
Size	720k byte, 1.44M byte	Up to 8M byte	Up to 512M byte * Note 1
Max Transfer Rate	18k byte/sec	500k byte/sec	150k byte/sec
Typical waveform Transfer Speed (Store/Recall)			
1000 point	1.1s / 0.4s	40ms / 30ms	140ms / 120ms
10000 point	1.8s / 1.0s	70ms / 60ms	240ms / 220ms
100000 point	7.5s / 6.5s	300ms / 300ms	1.0s / 0.9s
1M point	57s / 55s	2s / 2s	7.0s / 6.5s

Waveform File size: A channel-trace will use 1 byte per sample plus approximately 360 bytes of waveform descriptor. A processed trace will use 2 bytes per sample.

Template Size: Approximately 21k bytes.

Panel Setup Size: Approximately 3k bytes.

*Note 1: When available

PRINTER

Type: Raster printer, thermal.

Resolution: 190 DPI.

Printout Size: 126 mm x 90 mm

Paper: Thermal printer paper, 30 meter roll, 110 mm width, type Seiko or similar.

Printing speed: 6 seconds approx. for one screen.



LeCroy

The Digital Scope Specialists

AP003, AP020 and AP021 Active FET Probes

Main Features

- Bandwidths to 1 GHz
- LeCroy ProBus™ interface for the AP020 and the AP021
- 1 MΩ input Impedance
- Low capacitance at probe tip
- Rugged mechanical construction
- Automatic sensing and control on scopes equipped with ProBus™

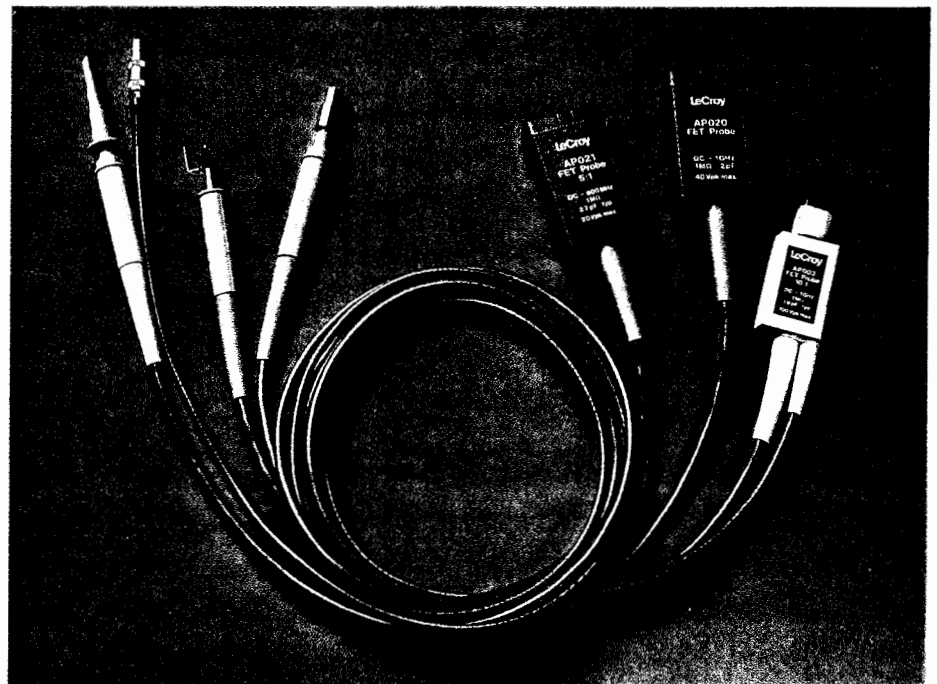

FET Probes provide the oscilloscope user with a higher level of measurement capability. Compared with passive probes, they offer low circuit loading, low capacitance and high bandwidth. This combination makes them the ideal tools for working on sensitive or high-speed electronics.

This performance is achieved by the integration of a high-impedance Field Effect Transistor (FET) amplifier into the probe tip. The circuit under test sees only the amplifier's input impedance - it is effectively buffered from the scope's input impedance and the probe cable.

LeCroy's AP series of FET probes are mechanically rugged in design, while their miniature construction allows them to be used in hand-held PCB probing applications. Their detachable tips are designed for simple replacement, and they are supplied with a full set of accessories.

Models AP020 and AP021 offer 1 GHz and 800 MHz Bandwidth respectively. AP020 features X10 signal attenuation and is especially recommended for LeCroy's 9320 and 9324 1 GHz oscilloscopes. The AP021 offers X5 attenuation when used with the new 9360.

As an active device, the FET probe requires a stabilized power supply. LeCroy provides an elegant solution to this with the ProBus™ probe interface.

ProBus™ provides probe power and signal connection in one integrated package. It also allows the scope to control other probe functions, such as input coupling and DC offset. The ProBus™ interface is now available on a growing range of LeCroy oscilloscopes and probes. AP003 has an external power connector for use with scopes which are not ProBus™ compatible. All other models use the ProBus™ interface.

Features and Benefits

Connecting a probe to a circuit can significantly distort its signals by adding undesired loading - mostly capacitive and resistive. FET probes offer high resistance and low capacitance therefore they present minimal loading to the circuit under test, and protect from making erroneous measurements.

HIGH RESISTANCE

Low resistance probes have significant DC effects when used in high impedance circuits. They can greatly affect the behaviour of the device under test by changing the swing and the DC offset of the probed signal. A 1 MΩ impedance FET probe will not affect gain or offset in virtually all the cases.

LOW CAPACITANCE

Although not important in DC measurements, capacitive loading is very

disruptive at high signal frequencies. The capacitive loading effects can be drastic. When probed with a 10 MΩ, 15

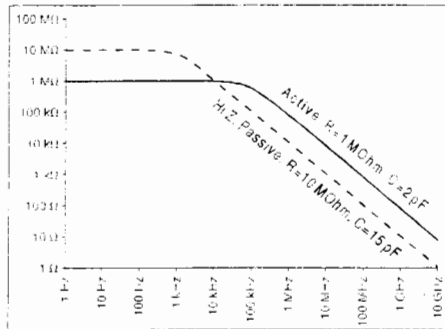

Probe Impedance versus Frequency

pF passive probe, a 100 MHz signal "sees" a 100 Ω load as illustrated on the picture below.

With only 2 pF of capacitance at the probe tip, LeCroy's FET probes reduce

circuit loading at high frequencies by a factor of 10. Minimizing tip capacitance can also push the probe's resonant frequency beyond the system bandwidth. Sensitivity to ground lead inductance is also minimized.

PROBUS

The ProBus™ system is a complete measurement solution from probe tip to oscilloscope display. It supplies power to active probes, while automatically sensing probe attenuation. ProBus™ enables direct control of the probe offset and input coupling from the scope's front panel, extending the instrument's accuracy up to the probe tip. In addition, ProBus™ automatically optimizes scope and probe offset adjustments, calibrates the gain at the probe tip and compensates for non-linearities, providing most accurate measurements.

Specifications

MODEL	AP003	AP020	AP021	MODEL	AP003	AP020	AP021
Bandwidth (MHz)	DC-1000	DC-1000	DC-800	Dynamic Range	±7 V	±5 V	±2.5 V
Risetime (psec)	< 350	< 350	< 437	DC Offset Range	N/A	±20 V	±10 V
Attenuation	10:1 ±2%	10:1±2%	5:1±2%	Input Coupling	DC	DC/AC	DC/AC
Output R (MΩ)	1 ±5%	1±2%	1±2%	Total length (m)	1.5	1.5	1.5
Input C (pF)	1.9 ±0.3	1.8 ±0.2	2.7 ±0.2	Power requirement	±12 V	±12 V	±12 V
Max Input Voltage	±100 V	±40 V	±20 V	Interface	N/A	ProBus™	ProBus™

Recommended Matching

LeCroy Model	AP-003	AP-020	AP-021
9304-10-14	XX		
9360-61			X
9320-24		X	
94XX	X		
7200	XX		
7200A	X		
ScopeStation	X		

X: External Power Supply not required

XX: External Power Supply required

Ordering Information

AP003	1 GHz active FET probe
AP020	1 GHz active FET probe
AP021	800 MHz active FET probe with ProBus™ interface. All probes are shipped with the following accessories: 1x Retractable hook 1x Ground Lead 1x BNC Adaptor 1x IC Tip
	3x Ground Bayonets Adaptor
AP501	Power Supply for the AP003

USA Direct Sales: 1 (800) 5LE-CROY

LeCroy Worldwide Sales Offices

ASIA/PACIFIC	LeCroy Pty Ltd	61.38.90.7358
BENELUX	LeCroy BV	04902.8.9285
CANADA	LeCroy Cnd	514.928.4707
FRANCE	LeCroy SARL	(1).69.18.83.20
GERMANY	LeCroy GmbH	06221.83.10.01
ITALY Milano	LeCroy SRL	02.204.70.82
ITALY Rome	LeCroy SRL	06.336.797.00
JAPAN Osaka	LeCroy Japan	0816.330.0961
JAPAN Tokyo	LeCroy Japan	0813.3376.9400
SWITZERLAND Geneva		022.719.21.11
SWITZERLAND Lenzburg		064.51.91.81
United Kingdom	LeCroy Ltd	0235-533114

Other sales and service representatives throughout the world.

Copyright © May, 1993. LeCroy is a registered trademark of LeCroy Corporation. All rights reserved. Information in this publication supersedes all earlier versions. Specifications subject to change without notice.

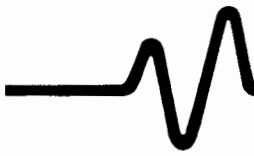

LeCroy

The Digital Scope Specialists

AP030, SI 9000 and SI 9000A Active Differential Probes

Main Features

- Bandwidths to 25 MHz
- Multiple:
 - Attenuations
 - Differential Voltage Ranges
 - Common Mode Voltages
- High Input Impedance
- Rugged and Lightweight
Mechanical Construction

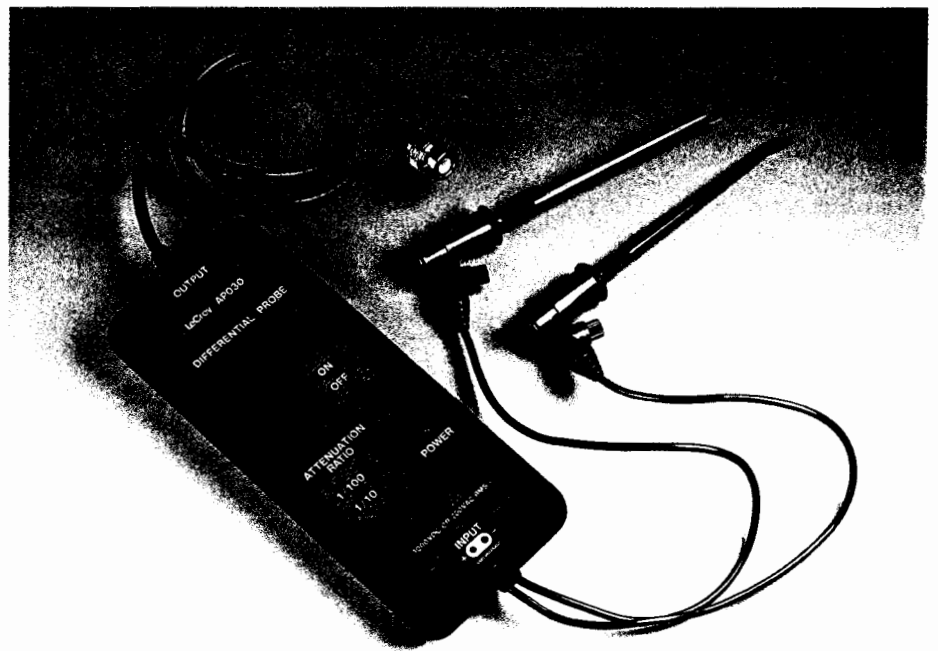

The Models AP030, SI 9000 and SI 9000A are fully differential active probes designed for applications where electric signals must be measured relative to a floating voltage, other than ground potential.

These probes are designed specifically for situations where:

- the reference voltage may be several hundreds volts above or below ground;

- measurements require the rejection of common-mode signals, (e.g. to evaluate small amplitude pulses riding on big common-mode signals);
- ground loops and currents produce so much interference that small signals cannot be detected.

With these differential probes the oscilloscope user avoids both the dangerous practice of floating the

scope, and the technique of using two scope channels in "Invert and Add" mode, which is limited both in common mode rejection and in dynamic range.

Models AP030, SI 9000 and SI 9000A are lightweight and easy to use. They have the rugged mechanical construction required for laboratory, manufacturing and field service environments, and are battery powered for greater safety and convenience.

Features and Benefits

FULLY DIFFERENTIAL INPUTS

The probes are fully differential active devices. The differential technique allows measurements to be made between two points in a circuit without reference to ground. The two input signals are processed inside the probe (as illustrated in figure) and the resulting single-ended signal may be measured by any grounded oscilloscope.

HIGH COMMON MODE VOLTAGE

The three probes offer a range of Common Mode Voltages from 40 V to 1000 V.

RUGGED CONSTRUCTION

The probes are designed to be compact and lightweight with power provided by four AA size 1.5 V batteries. A rubber casing enhances the probes' resistance to shocks.

SAFETY

Use of differential probes is safe within the specified voltages. Their

use avoids less reliable alternatives, or possible dangerous practices.

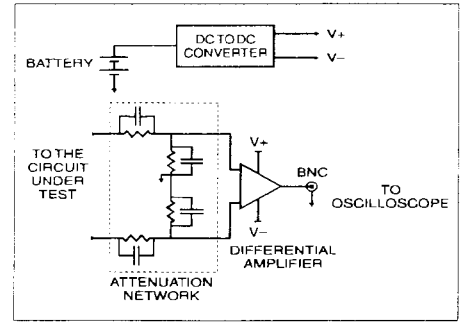

Specifications

MODEL	AP030	SI 9000	SI 9000A
Bandwidth (MHz)	15 MHz	15 MHz	15 MHz
Risetime	24 ns	24 ns	24 ns
Attenuation	1:10/1:100	1:20/1:200	1:50/1:500
Atten. Accuracy	2%	2%	2%
Input Resistance	2 MΩ	2 MΩ	2 MΩ
Input Capacitance	12 pF each side to ground		
Input Configuration	Differential		
Input Voltage			
Differential Max	±400 VDC or 280 Vrms for 1:100 ±40 VDC or 28 Vrms for 1:10	±700 VDC or 500 Vrms for 1:200 ±70 VDC or 50 Vrms for 1:20	±1000 VDC or 700 Vrms for 1:500 100 VDC or 70 Vrms for 1:50
Common Mode Max	±420 VDC or 300 Vrms	±700 VDC or 500 Vrms	±1000 VDC or 700 Vrms
Absolute Max	±1000 VDC or 700 Vrms		
CMRR			
50Hz	-90db	-80db	-80db
1KHz	-80db	-70db	-70db
1MHz	-53 db	-45db	-45db
Output Voltage			
Amplitude Max	±4 V	±3.5 V	±2 V
Offset	<± 5 mV	<±10 mV	<±10 mV
Noise	typical -10° C to +40° C 1.5 to 2mV typical		
Source Impedance	1Ω at 1 KHz, 8Ω at 1 MHz typical		
Ambient Temperature			
Operating	-10° C to +40° C		
Storage	-30° C to +70° C		
Power requirement	Four internal 1.5 V AA size batteries or external AC to 6 Vdc adaptor Typical consumption 50 mA		
Dimensions	6.6" (168mm) x 2.4" (62mm) x 0.79" (20mm) excluding casing		
Weight	9.35 oz (265 gr) excluding batteries and casing		

Ordering Information

AP030	25 MHz differential probe 1:10 / 1:100
SI 9000	25 MHz differential probe 1:20 / 1:200
SI 9000A	25 MHz 1:50 / 1:500

All models are delivered with rubber casing. Batteries not included

USA Direct Sales: 1 (800) 5LE-CROY

LeCroy Worldwide Sales Offices

ASIA/PACIFIC	LeCroy Pty Ltd	61.38.90.7358
BENELUX	LeCroy BV	04902.8.9285
FRANCE	LeCroy SARL	(1).69.18.83.20
GERMANY	LeCroy GmbH	06221.83.10.01
ITALY	LeCroy SRL	06.336.797.00
JAPAN Osaka	LeCroy Japan	0816.330.0961
JAPAN Tokyo	LeCroy Japan	0813.3376.9400
SWITZERLAND Geneva		022.719.21.11
SWITZERLAND Lenzburg		064.51.91.81
United Kingdom	LeCroy Ltd	(0235) 533114

Other sales and service representatives throughout the world.

Copyright October, 1993. LeCroy is a registered trademark of LeCroy Corporation. All rights reserved. Information in this publication supersedes all earlier versions.

Specifications subject to change without notice.

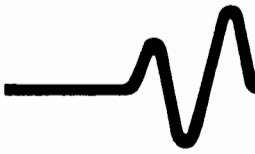

LeCroy

The Digital Scope Specialists

"Mega" Waveform Processing (MWP) for the 9304AM, 9310AM-L and 9314AM-L

Main Features

- Larger system memory extends math processing capacity on long waveforms.
- 1 M point waveforms can be read back into the oscilloscope.
- Improved processing speed.
- System memory is dynamically allocated to traces.

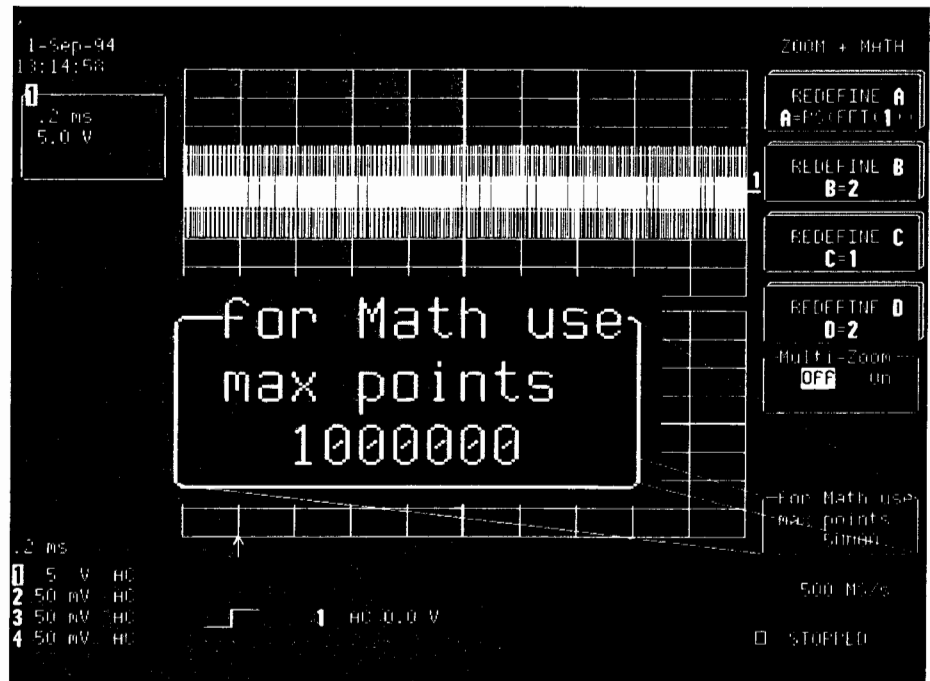

Extended processing

The "No Math on Large Waveforms" message has been consigned to the archives. The MWP option stretches the math processing frontier for these machines, which you can now upgrade to average a 1 million point "mega" trace. MWP also extends the capacity of the oscilloscope's internal memories.

Smart memory allocation

With up to 16MB of system memory, the MWP option dramatically improves the processing power of the machine. And with the smart memory allocation, all of this memory can be dynamically dedicated to one demanding task, an FFT for example, freeing up the memory unused by other traces.

Faster update

This new processor enhances the processing speed to yield an essential improvement in the overall DSO response. The trace update rate is amazingly fast – analog fast. Also, the data processing functions have never looked so "live", providing the instantaneous response needed when fine-tuning a critical circuit under test.

Why more memory?

The example illustrated in the following screenshots clearly demonstrates the advantage of processing memory for the FFT computation. For a given time window and a given acquired record length, more processing memory dramatically expands the frequency spectrum of an FFT.

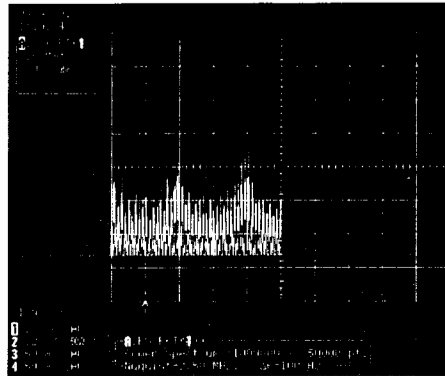

Without MWP option: The FFT processing of a 1 M point record length is limited to 50k; as a result the spectrum is limited to 2.5 MHz.

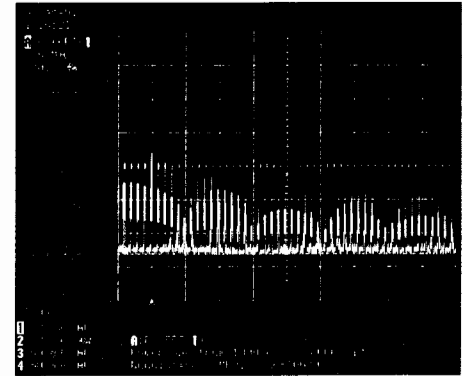

With MWP option: The same signal processed with a 500k FFT shows a full spectrum of 50 MHz.

Specifications

SYSTEM MEMORY

The MWP option increases the standard system memory (2 MB) to 8 MB for "M" models and to 16 MB for "L" models.

PROCESSOR

The MWP option upgrades the standard 16 MHz 68020/68881 processor system, to a 32 MHz 68EC030/68882 system.

Task example	Without MWP	With MWP
Retrieve a 1M waveform saved on a floppy, to the scope	Impossible; requires more than 2MB of memory	Possible.
Perform an FFT on a 200k waveform	Possible, by limiting the input points, which also limits the resulting FFT bandwidth	Possible without reducing the input points. The FFT spectrum will cover the full bandwidth.
Average 1000-point waveforms at a 100 Hz sweep rate	Impossible, the maximum rate is 80 Hz: some events will be missed.	Possible, the maximum rate can actually reach 125 Hz – a 56% improvement!

Ordering Information

- 93XX-MWP-M MWP option for:
9304AM
9310AM
9314AM
- 93XX-MWP-L MWP option for:
9310AL
9314AL
- 93XX-RK-MWPM Retrofit kit for:
9304AM
9310AM
9314AM
- 93XX-RK-MWPL Retrofit kit for:
9310L
9314L
9310AL
9314AL

USA Direct Sales: 1 (800) 5LE-CROY

LeCroy Worldwide Sales Offices

- ASIA/PACIFIC LeCroy Pty Ltd 61.38.90.7358
- BENELUX LeCroy BV 04902.8.9285
- FRANCE LeCroy SARL (1).69.18.83.20
- GERMANY LeCroy GmbH 06221.83.10.01
- ITALY LeCroy SRL 06.336.797.00
- JAPAN Osaka LeCroy Japan 0816.330.0961
- JAPAN Tokyo LeCroy Japan 0813.3376.9400
- SWITZERLAND Geneva 022.719.21.11
- SWITZERLAND Lenzburg 064.51.91.81
- United Kingdom LeCroy Ltd (01235) 533114

Other sales and service representatives throughout the world.



Copyright October, 1994. LeCroy is a registered trademark of LeCroy Corporation. All rights reserved. Information in this publication supersedes all earlier versions.

Specifications subject to change without notice.

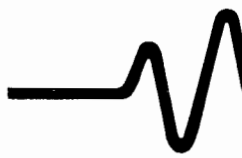

LeCroy

The Digital Scope Specialists

WP01 Waveform Processing Firmware for the 9300 Family of Digital Oscilloscopes

Main Features

- High-precision averaging up to 1 million sweeps
- Extended digital filtering capabilities
- Rescale function, with $(ax + b)$ correction factor
- Envelope mode
- Integration
- Differentiation
- $\text{Log}(e)$ and $\text{Log}(10)$
- $\text{Exp}(e)$ and $\text{Exp}(10)$
- Absolute, Reciprocal
- Square, Square root
- Powerful function chaining feature

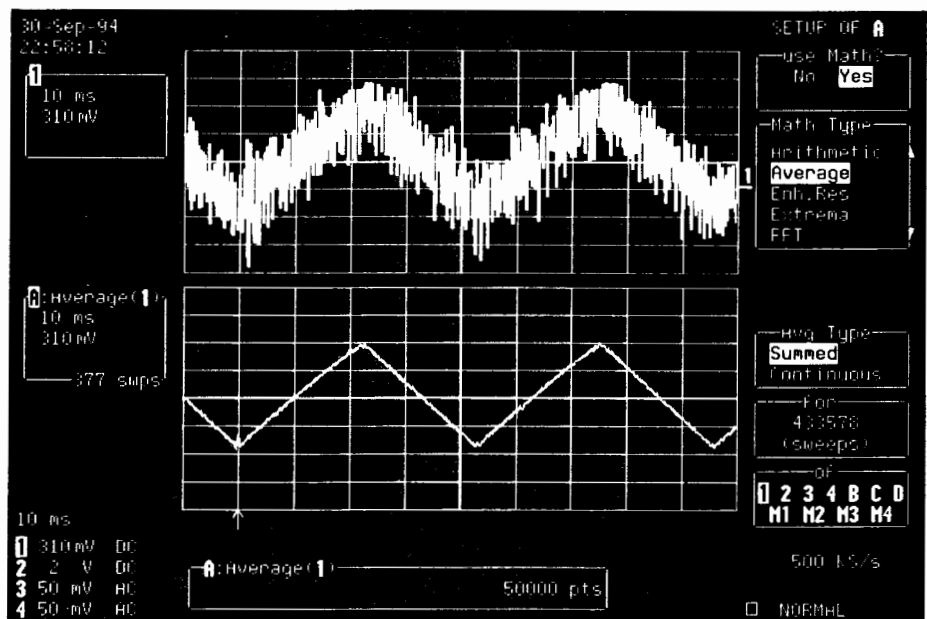

Summed Averaging is applied to the signal in Channel 1, to remove random noise. Trace A shows the result after 377 sweeps: the noise has practically disappeared.

The LeCroy WP01 Waveform Processing package features a powerful toolset that extends the processing power inside the 9300 oscilloscope, well beyond the capabilities of a traditional instrument.

In fact, all the processing is built-in to eliminate the need for external computers and controllers. High-speed microprocessors are used to ensure real-time updates of computed waveforms on the screen.

The package is fully programmable over GPIB or RS-232-C interfaces, and hard copies can be made directly on to a wide range of printers (including the optional internal printer), plotters or graphic formats.

Features and Benefits

EXTENSIVE SIGNAL AVERAGING

WP01 offers two powerful, high-speed averaging modes that can be used to reduce noise and improve the signal-to-noise ratio. Vertical resolution can be extended by several bits to improve dynamic range and increase the overall input sensitivity to as much as 50 $\mu\text{V}/\text{div}$.

Summed averaging, where up to 1,000,000 sweeps are repeatedly summed, with equal weight, in a 32-bit accumulation buffer for improved accuracy. The accumulated result is then divided by the number of sweeps.

Continuous/exponential averaging where a weighted addition of successive waveforms can be performed with weighting factors from 1:1 to 1:1023. The averaging goes on indefinitely with the contribution of "older" sweeps gradually decreasing. The method is particularly appropriate to reduce noise on signals drifting very slowly in time or amplitude.

ENHANCED RESOLUTION BY DIGITAL FILTERING

Allows low-pass F.I.R. filtering of the digitized signals, with 6 different cut-off frequencies per sampling rate setting. As a result, the vertical resolution of the captured signals – single-shot or repetitive – increases from 8 bits to 11 bits in 0.5-bit steps. This feature is ideal to strip off unwanted high-frequency noise on transient events.

RESCALING

Allows an input signal to be rescaled using a $(ax + b)$ correction factor to compensate for gain and offset. This is very useful when dealing with various types of transducers, to read the correct temperature or pressure value directly from the scope's cursor.

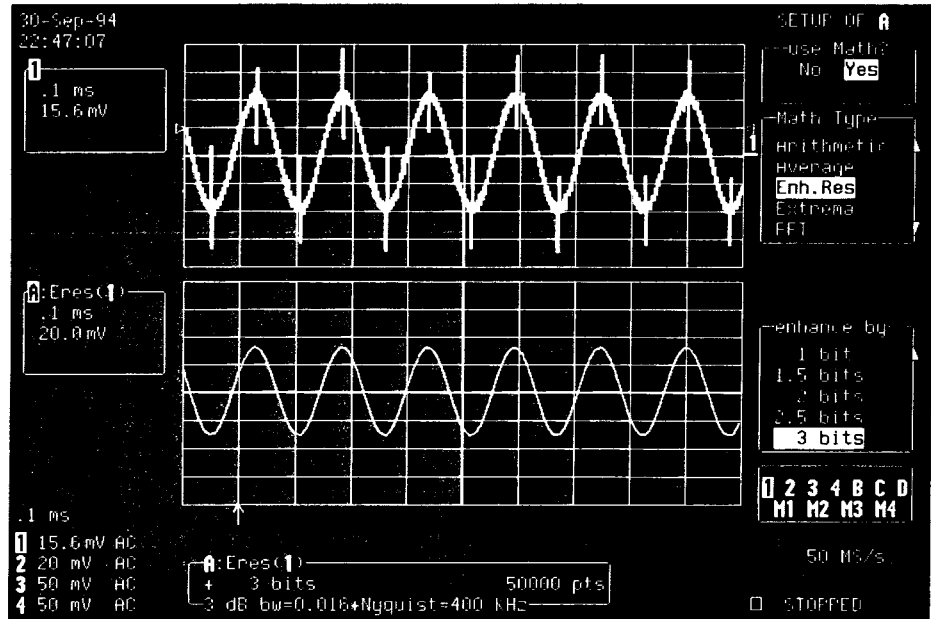

High-frequency glitches in Channel 1 have been dramatically reduced in Trace A by using the low-pass filtering properties of the Enhanced Resolution Function.

ENVELOPE MODE

Shows the signal envelope by retaining only the highest and lowest amplitudes for every sampling interval, over a user-definable number of sweeps. Ideal to visualize the time or amplitude jitter in a signal.

POWERFUL MATH TOOLSET

In addition to the basic arithmetic functions found in the standard models (+, -, ×, ÷), WP01 adds an impressive set of functions such as integration, differentiation, logarithms and exponential – in both bases 10 and e – square, square root, reciprocal, absolute, and a $\sin(x)/x$ interpolation function.

All these functions are updated automatically each time a new waveform is acquired, showing a "live" representation of a computed trace. This would be impossible to achieve on a separate computer.

FUNCTION CHAINING

When more than one math function is needed in the equation, WP01 supports function chaining, and allows the user to multiply, for instance, the "Voltage" and the "Current" channel and to integrate the result to get an instantaneous energy curve.

REMOTE CONTROL

All of the waveform processing can be controlled via GPIB or RS-232-C remote control. And the function traces do not even need to be called up on screen to be updated, an important feature that speeds up the computation.

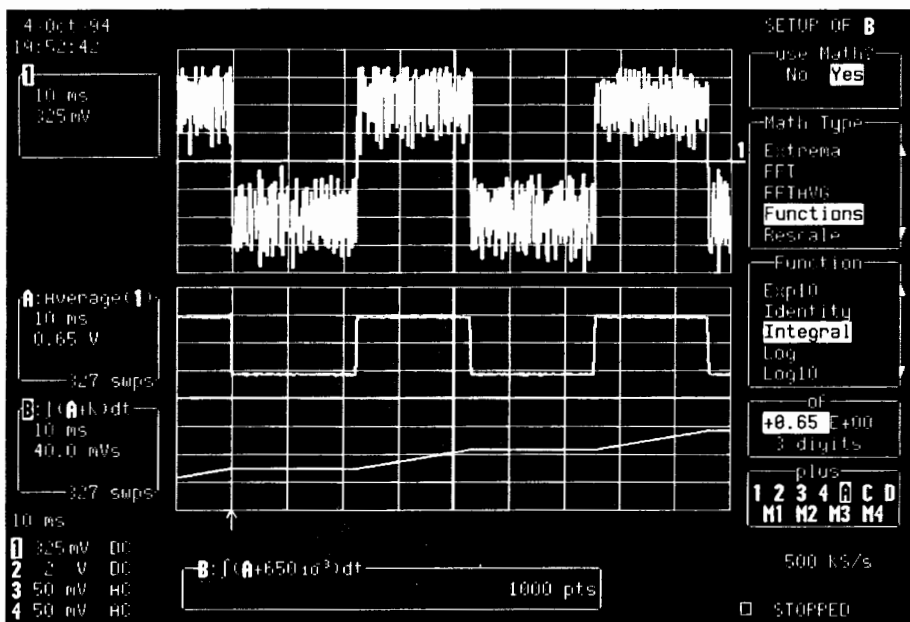

To illustrate WP01's function chaining ability, the noisy signal in Channel 1 has been averaged in Trace A to remove undesired noise, and the result integrated in trace B.

WP01 Specifications

GENERAL

Max. number data points: only limited by the available amount of system memory (indicated in the "memory used" status menu).

Min. number data points: Data points can be reduced down to 50 in the processing function to improve update rate.

Vertical Zoom: supported, 50× maximum.

Horizontal Zoom: supported, maximum zooming to a point where 50 samples of the source trace occupy the full screen.

Maximum Sensitivity: 50 μ V/div after vertical expansion.

SUMMATION AVERAGING

Number of Sweeps: 1 to 1,000,000.

Speed: up to 200,000 points/s.

CONTINUOUS AVERAGING

Possible Weighting Factors: 1:1, 1:3, 1:7, 1:15, 1:31, 1:63, 1:127, 1:255, 1:511 and 1:1023.

ENHANCED RESOLUTION

Choice of six low-pass filters to improve vertical resolution improvement from 8 to 11 bits in 0.5-bit steps.

Resulting bandwidth:

0.5 bit	$0.5 \times$ Nyquist BW
1 bit	$0.241 \times$ Nyquist BW
1.5 bit	$0.058 \times$ Nyquist BW
2 bit	$0.029 \times$ Nyquist BW
2.5 bit	$0.016 \times$ Nyquist BW

Nyquist BW = $1/2 \times$ sample frequency.

RESCALE

ax + b rescaling with a and b ranging from ± 0.00001 E-15 to ± 9.99999 E+15

ARITHMETIC

Addition, subtraction, multiplication and ratio on any two waveforms.

FUNCTIONS

Identity, negation, integration (including additive constant), differentiation, square, square root, logarithm and exponential (base e and 10), sin x/x, reciprocal and absolute value of any waveform.

EXTREMA

Shows the signal envelope by retaining only the highest and lowest amplitudes for every sampling interval. Logs all extreme values of a waveform over a programmable number of sweeps. Maxima and minima can be displayed together, or separately by choosing *roof* or *floor* traces.

Number of Sweeps: 1 to 1,000,000.

FUNCTION CHAINING

Up to four functions can be automatically chained using traces A, B, C and D. Using memories M1 to M4 for intermediate results, any number of operations can be chained manually or via remote control.

REMOTE CONTROL

All controls and waveform processing functions are fully programmable using simple commands over the oscilloscope's GPIB or RS-232-C interfaces.

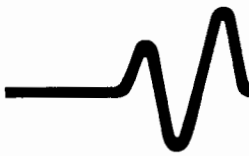

WP02 Spectrum Analysis Firmware for the 9300 Family of Digital Oscilloscopes

Main Features

- Frequency range from DC up to the instrument's full bandwidth
- Simultaneous FFTs on up to 4 channels
- Frequency resolution down to 100 μ Hz
- Frequency domain averaging
- Wide selection of scaling formats
- 5 window functions
- Up to 5 1000-point FFTs per second
- Full support of cursors and automatic waveform parameters
- Full PASS/FAIL testing support

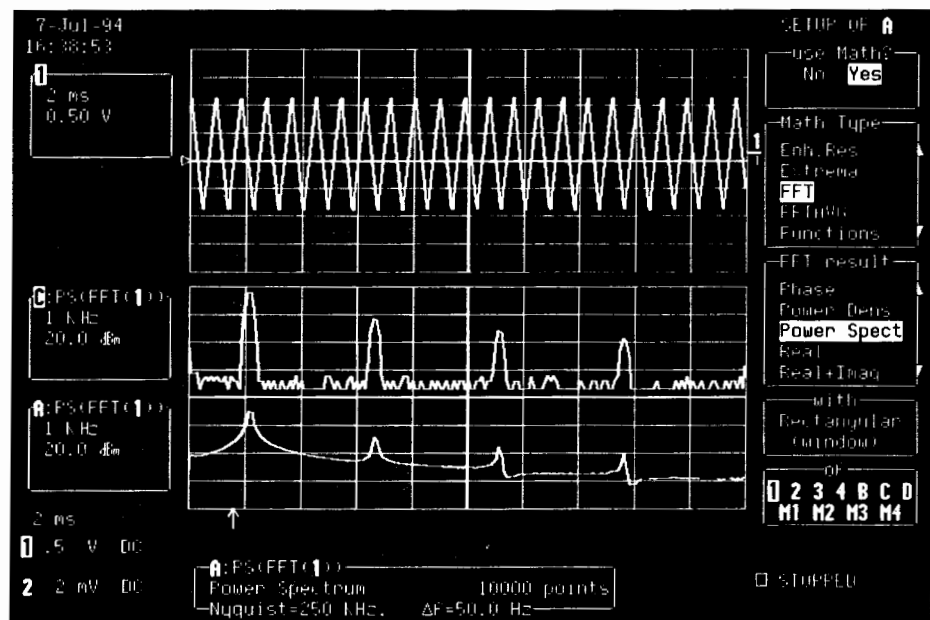

Adding the WP02 Spectrum Analysis Package to the 9300 family of digital oscilloscopes provides a fast and economical solution to frequency domain applications.

The WP02 Spectrum Analysis package provides the 9300 oscilloscope with a powerful frequency-domain toolset that extends its processing capabilities, well beyond the realm of a standard instrument. In fact, all the processing is built-in to eliminate the need for external computers and controllers.

High-speed microprocessors are used to ensure real-time update of computed waveforms on the screen. Fast Fourier Transforms (FFTs) rapidly convert time domain waveforms into frequency domain records to reveal valuable spectral information such as phase, magnitude and power.

The package is fully programmable over GPIB and RS-232-C interfaces, and hardcopies can be made directly on to a wide range of printers (including the optional internal printer), plotters or graphic formats.

Features and Benefits

WHY FFT IN A SCOPE?

The FFT package on a LeCroy 9300 has at least four clear advantages over common swept spectrum analyzers:

- It can show the spectrum of a **transient signal**.
- Both **time and frequency** information can be monitored **simultaneously**.
- Phase information is **available**.
- The price is **attractive**.

It has two definite advantages over FFT analyzers:

- It can show higher-frequency components.
- Both **time and frequency** information can be monitored **simultaneously**.
- The price is **attractive**.

BROAD SPECTRUM COVERAGE

The frequency spectrum ranges from DC to the full bandwidth of the oscilloscope for repetitive signals, and to one half of the maximum sampling frequency for transients.

MULTI-CHANNEL ANALYSIS

All input channels can be analyzed simultaneously to look for common frequency-domain characteristics in independent signals.

VERSATILE SCALING FORMATS

Frequency-domain data may be presented as magnitude, phase, real, imaginary, complex, log-power and log-PSD (Power Spectral Density).

STANDARD WINDOW FUNCTIONS

Use rectangular for transient signals; von Hann (Hanning) and Hamming for continuous waveform data; Flattop for accurate amplitude measurements; Blackman-Harris for maximum frequency resolution.

FREQUENCY DOMAIN AVERAGING

Up to 50,000 FFT sweeps may be averaged to reduce base-line noise, enable analysis of phase-incoherent signals or signals which cannot be triggered on.

FREQUENCY CURSORS AND WAVEFORM PARAMETERS

Cursors can be set on the FFT trace to show up to 0.004% frequency resolution (up to 0.002% for 10,000 point memory) and measure power or voltage differences to 0.2% of full scale. Automatic waveform param-

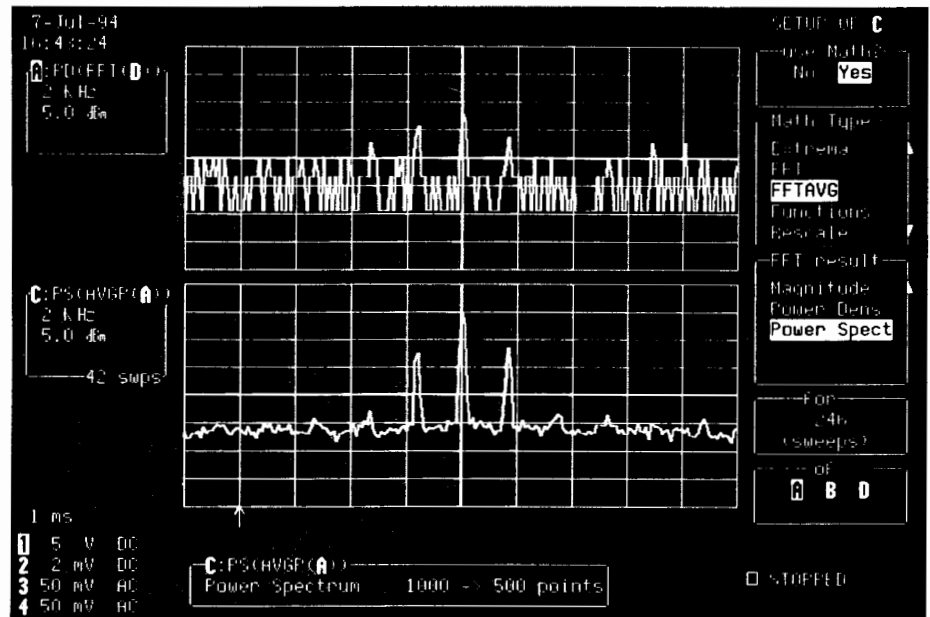

An FFT (top trace) with spectral components buried in noise. By applying the power averaging function (lower trace), all the baseline noise is removed, and the spectral components of an AM signal are clearly visible.

eters can also be applied to FFT traces.

PASS/FAIL TESTING ON FFT TRACES

PASS/FAIL testing is fully supported on FFT traces. The instrument can be setup to test incoming spectra against tolerance masks. In case the signal "fails", the instrument can be programmed to perform a choice of actions (screen dump, waveform storage, pulse out, etc.)

RESCALING

Allows an input signal to be rescaled using a $(ax + b)$ correction factor to compensate for gain and offset. This is very useful when dealing with various types of transducers, to read the correct temperature or pressure value directly from the scope's cursor.

FUNCTION CHAINING

When more than one math function is needed in the equation, WP02 supports function chaining, and allows the user to multiply, for instance, the "Voltage" and the "Cur-

rent" channel and to integrate the result to get an instantaneous energy curve.

REMOTE CONTROL

All of the waveform processing can be controlled via GPIB or RS-232-C remote control. And the function traces do not even need to be called up on screen to be updated, an important feature that speeds up the computation.

FOURIER PROCESSING

Fourier processing is a mathematical technique which enables a time-domain waveform to be described in terms of frequency-domain magnitude and phase, or real and imaginary spectra. It is used, for example, in spectral analysis where a waveform is sampled and digitized, then transformed by a Discrete Fourier Transform (DFT). Fast Fourier Transforms (FFT) are a set of algorithms used to reduce the computation time (by better than a factor of 100 for a 1000 point FFT) needed to evaluate a DFT.

WP02 Specifications

GENERAL

Max. number data points: only limited by the available amount of system memory (indicated in the "memory used" status menu).

Min. number data points: Data points can be reduced down to 50 in the processing function to improve update rate.

Vertical Zoom: supported, 50× maximum.

Horizontal Zoom: supported, maximum zooming to a point where 50 samples of the source trace occupy the full screen.

Maximum Sensitivity: 50 μV/div after vertical expansion.

Frequency Range:

Repetitive signals: DC to instrument bandwidth.

Transient signals: DC to 1/2 maximum single-shot sampling frequency

Frequency Scale Factors: 0.05 Hz/div to 0.2 GHz/div in a 1-2-5 sequence.

Frequency Accuracy: 0.01%.

AMPLITUDE AND PHASE

Amplitude Accuracy: Better than 2%. Amplitude accuracy may be modified by the window function (see the window functions table).

Signal Overflow: A warning is provided at the top of the display when the input signal exceeds the ADC range.

Number of Traces: Time domain and frequency domain data can be displayed simultaneously (up to 4 waveforms).

Phase Range: -180° to +180°.

Phase Accuracy: ±5° (for amplitudes > 1.4 div).

Phase Scale Factor: 50° /division.

SPECTRUM SCALING FORMATS

Horizontal Scale: Linear, in Hz

Vertical Scales:

Power Spectrum in dBm (1 mW into 50 Ω).

Power Spectral Density (PSD) in dBm.

Magnitude, Real, Imaginary: Linear, in V/div

Phase Display: Linear, in degrees.

WINDOW FUNCTIONS

Rectangular, von Hann (Hanning), Hamming, Flattop and Blackman-Harris (see table below).

FFT EXECUTION TIMES*

100 points in less than 0.03 s.

1000 points in less than 0.3 s.

10000 points in less than 3 s.

* Only valid for 9350, 9360, and 9304/10 with MWP option. Other models, add 50%

FREQUENCY DOMAIN POWER AVERAGING

Summation averaging of power, PSD or magnitude for up to 50,000 sweeps.

FUNCTION CHAINING

Up to four functions can be automatically chained using traces A, B, C and D. Using memories M1 to M4 for intermediate results, any number of operations can be chained manually or via remote control.

REMOTE CONTROL

All controls and waveform processing functions are fully programmable using simple commands over the oscilloscope's GPIB or RS-232-C interfaces.

FILTER PASS BAND AND RESOLUTION

Window type	Filter bandwidth at -6 dB [freq. bins]	Highest side lobe [dB]	Scallop loss [dB]	Noise bandwidth [freq. bins]
Rectangular	1.21	-13	3.92	1.0
von Hann	2.00	-32	1.42	1.5
Hamming	1.81	-43	1.78	1.36
Flattop	1.78	-44	0.01	2.96
Blackman-Harris	1.81	-67	1.13	1.71

Filter Bandwidth at -6 dB characterizes the frequency resolution of the filter.

Highest Side Lobe indicates the reduction in leakage of signal components into neighboring frequency bins.

Scallop Loss is the loss associated with the picket fence effect.

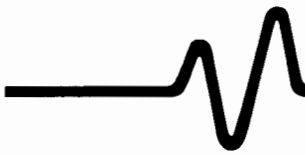

LeCroy

Innovators in Instrumentation

LeCalsoft—Calibration Software for LeCroy Digital Oscilloscopes

Main Features

- Traceability to reference standards
- Computer check of key specifications
- Computer-aided readjustment
- Fully automated configurations available
- Supports all 93XX and 94XX models
- IBM[®] PC-AT compatible



The LeCalsoft package enables a fast and thorough verification of all key specifications.

General

The LeCroy LeCalsoft (94XXCS05) test and calibration package provides a convenient, unambiguous check of LeCroy oscilloscopes. Designed for users who require traceability to reference standards (NIST, etc.), this package is ideally suited for use in calibration laboratories where the oscilloscopes are checked at fixed intervals.

Results of the calibration check are fully documented on hard copy, or they can be archived on hard disk or diskette.

LeCalsoft works on any PC compatible with the IBM[®]-AT standard. It controls the oscilloscope and the calibration sources through a National Instruments[®] GPIB interface.

Features

Calibration Check

All the essential specifications of the Digital Oscilloscope, such as bandwidth, linearity, noise, trigger, timebase and effective-bit count are tested. Deviations from nominal values are calculated and displayed on the screen, printed, or archived on hard disk or diskette.

Comprehensive Documentation of the Test Results

At the end of each calibration check, two types of documentation are available: a long form printout which gives details of the results of all the tests executed, and states whether or not the results are within the specifications, and a short form printout which gives a summary of the test results.

Calibration Traceable to National Standards (NIST, etc.)

By using signal sources traceable to a standard, the calibration will be traceable to the same standard, provided the relevant documentation is maintained.

Manual and Automated Calibration Check

Both manual operation with computer assistance, and automated operation are possible. Automated operation requires programmable multiplexer and signal sources. See the list of supported devices below.

Assisted Adjustment of the Oscilloscope

A computer-aided adjustment procedure is also provided. By following instructions on the screen, the trained technician is guided through the adjustments required to correct the settings of the oscilloscope so that it is within the specifications.

Calibration Certificate

On request, LeCroy will perform calibration traceable to National Standard Organizations. Calibration certificates are provided as part of this service.

Functional Description

Calibration Practice

LeCroy oscilloscopes are auto-calibrating digital oscilloscopes and therefore do not require regular calibration like analog oscilloscopes. However, for users who require traceability to reference standards (such as those provided by the National Institutes of Standards and Technology), and for calibration laboratories which must inspect incoming instruments and perform recalibration at prescribed intervals, the LeCalsoft computer-aided test and calibration packages provide an easy solution.

Under guidance of the LeCalsoft program, some adjustments to the oscilloscope can be made by an electronics technician. However major deviations from specifications usually require repair by a trained service engineer. LeCroy regularly schedules training classes. If no in-house trained person is available, the nearest LeCroy service center can carry out repairs and calibration, and provide traceability to reference standards.

Using the LeCroy LeCalsoft Packages

For calibration checking, digital oscilloscopes have a great advantage over analog oscilloscopes because waveforms can be transferred to a host computer. This simplifies the calibration procedure enormously, makes it potentially faster and allows an extensive range of tests with unambiguous interpretation of the results.

LeCalsoft performs an extensive series of tests which verify the specifications of the oscilloscope. It includes many tests relevant to analog scopes such as Noise and Linearity tests. Although these tests are difficult and time consuming on an analog oscilloscope, they can be computer controlled and are quickly and easily performed on a digital oscilloscope. Tests which are specific to digital oscilloscopes, such as Sinefit tests are also included.

The various test options in LeCalsoft are presented to the operator in the form of a simple menu system. The user has the choice of performing an automated calibration check of the oscilloscope, or individually testing any of the specifications. Some of the tests require the use of high-quality external signal generators. The user receives instructions on

the screen when it is necessary to change the cable connections, but apart from this minor intervention, the tests are fully computer controlled when supported GPIB-programmable instruments are used.

Supported Instrumentation

LeCalsoft software works on any AT-compatible equipped with a math coprocessor and a National Instruments GPIB interface. Automated calibration checking is possible using a set of instruments from the following list. (For an automated calibration check, either the LeCroy or Keithley programmable multiplexer is required to feed the calibration signals to the oscilloscope input.)

RF sinewave generators:
Marconi 2019A, 2022C, 2030, 2031
Fluke 6060B, 6061A
Hewlett-Packard 8642A, 8642B
Rohde & Schwarz SMX

AF sinewave generators:
Marconi 2019A, 2022C, 2030, 2031
Hewlett-Packard 8642A, 8642B
Rohde & Schwarz SMX
Tektronix FG5010
LeCroy AFG 9100

DC Precision Power Supply:
Tektronix PS5004
Datron 4708 Autocal Multifunction Standard

Fast Pulse Generator:
Tektronix CG5001/CG551AP

Power Meters:
Hewlett-Packard HP436A, HP437B

Multiplexers:
Keithley 199 SYSTEM DMM/
SCANNER with LeCroy interface board.
LeCroy 4951, 4973-1, 4973-2
Multiplexers.

Frequency standard:
WWV or HBG1500

Recommended Accessories

A full kit of calibration connectors and interfaces is available from LeCroy. It includes all the necessary cables, adapters, splitters and filters, as well as the Programmable Multiplexer. Also available is a repair package including special tools, board extenders, etc., for computer-aided adjustment.

Use of Other Instruments

It is possible to perform the calibration check with some other unsupported signal sources. However, the user is then required to set up these instruments manually and to perform one measurement at a time. The LeCalsoft package

guides the user step by step, and controls the oscilloscope data acquisition and the computation of the results.

LeCalsoft compares the signal measured by the oscilloscope with the signal it would expect to receive from the generator. Warning messages are displayed

whenever tolerances are exceeded. Some of the adjustments may be carried out by the user when the test sequence is finished. In this case, the software will guide the user through the correct adjustment procedure. At the end of the calibration check, a printout can be generated to list the results.

Specifications

Computer Required: Any PC compatible with the IBM-AT standard, and equipped with a mathematical coprocessor and a National Instrument Inc. GPIB interface.

Operating System: DOS 3.0 upward

Medium: 3¹/₂" 1.44 Mb
5¹/₄" 1.2 Mb diskette

Major Tests Supported by LeCalsoft

Internal

To ensure proper calibration of the oscilloscope, internal auto-calibration tests are automatically executed during normal operation. This standard sequence of internal auto calibration tests is initiated by the software and the results are transferred to the PC for analysis.

The tests are:

- Calibration of the resolution of the time-to-digital converter with respect to the system clock
- Determination of the gain constants of the input amplifiers
- Offset compensation versus gain variation
- Global internal non-linearity
- General functionality check

Bandwidth

To calculate the bandwidth, the amplitudes of sine waves of increasing frequencies are measured. The sine wave generator is first set to 500 kHz with an amplitude 75% of full screen, i.e. ± 3 vertical divisions. The frequency is then swept up to the point where an amplitude drop of 3 dB is observed. This indicates the bandwidth.

This test is executed on all channels for 1 M Ω and 50 Ω input impedance and for all vertical sensitivities. It requires a sine wave generator with good flatness.

Generators supported under program

control are listed on page 2.

Linearity

15 different known voltages, varying from 5% to 95% of full screen, are applied by the external voltage reference source. For each voltage value, a full waveform is acquired, and the mean value is compared to the known input voltage. The linearity is determined through a linear regression fit to the 15 measurements. The slope, the offset and the chi-square of the fit are computed.

With the linearity test, many other related tests are performed: response time of the overload protection of the 50 Ω input, linearity of the variable gain calibration, range and linearity of the offset setting, and quality of the input coupling.

This procedure is executed on all channels for both 1 M Ω and 50 Ω input impedance. The test requires a DC source with a precision and time stability of 0.1%, a voltage range of 0 V to 20 V adjustable in steps of 5 mV, and an output current capability of 300 mA.

Power supplies supported under program control are listed on page 2.

Noise

The noise tests are executed on all channels for both 1 M Ω and 50 Ω input impedance, with AC and DC coupling, five different time-base settings, and open inputs. Full waveforms are acquired with different offset values. The peak-to-peak as well as the RMS values of each measurement are computed, and the maximum values are recorded. The program also indicates the occurrence of any "flyers", i.e. short noise peaks generated by the ADC's.

The noise tests also include:

- checking the linearity of the variable offsets of all channels between 2.5% and 97.5% of full screen.

- checking the stability of the ground line when switching the inputs between GROUND and DC coupling modes.

Rise time/Overshoot

Executed on all channels for both 1 M Ω and 50 Ω input impedance, these tests measure the rise time of the oscilloscope response to the input voltage step, as well as the amount of pre-shoot and overshoot. They require a voltage step generator with calibrated fast rise-time amplitude.

The Voltage Step Generator supported under program control is the Tektronix CG5001.

Sinefit

The performance of the analog-to-digital converter is evaluated in terms of the number of effective bits (a measure of the signal-to-noise ratio). It is measured on all channels, at a sensitivity of 50 mV/div., by applying a pure sine wave at varying frequencies and timebase settings.

This test is a measurement of dynamic linearity. It shows the effect of such errors as noise, non-linearities and aperture jitter.

Timebase

The timebase test compares the internal clock with a very precise and stable external timebase reference (clock generator) such as the WWV standard or HBG 1500.

Trigger

The trigger capabilities are tested for all possible configurations. These include:

- Internal and external trigger sources
- DC, AC, HF-reject, and LF-reject couplings
- Trigger level settings in all slope modes.

ORDERING INFORMATION

LeCalsoft and Options

94XXCS05 Complete LeCalsoft for 93XX and 94XX (software and hardware), incl. cables, switch card, adapters, etc.
94XXCS01 LeCalsoft software for 93XX and 94XX
9400CS01 Calsoft software for 9400A

LeCalsoft Accessories

93XXKCS02 Calibration kit for 93XX and 94XX
9400KCS02 Calibration kit for 9400A
Individual system components available on request

U.S. REGIONAL SALES OFFICES 1 800-5-LeCroy (1-800-553-2769):

automatically connects you to your local sales office.

LeCroy has sales engineers in most major metropolitan areas, coordinated through a system of five Regional Sales and Service Offices:

NORTHEAST: 700 Chestnut Ridge Rd,
Chestnut Ridge, NY 10977

SOUTHEAST: 410 Ware Blvd Ste 716,
Tampa, FL 33619

FARWEST: 5912 Stoneridge Mall Rd
Ste 150, Pleasanton,
CA 94588

CENTRAL:

Midwest: 4811 S 76th St Ste 415,
Greenfield, WI 53220

Southwest: 14800 Central Ave SE
Albuquerque, NM 87123

WORLDWIDE

Argentina: Search SA, (01) 394-5882

Australia: Scientific Devices Pty Ltd,
(03) 579-3622

Austria: Dewetron GmbH, (0316) 391804

Benelux: LeCroy BV (0031) 4902-89285

Brazil: ATP-Hi-Tek, (011) 421-5477

Canada: LeCroy Canada Inc,
(514) 928-4707

Denmark: Lutronic, (42) 459 764

Eastern Europe: Elsinco GmbH, Vienna,
222 812 1751

Finland: Labtronic OY, (80) 847 144

France: LeCroy Sarl (1) 69 073 897

Germany: LeCroy GmbH, (06221) 831001

Greece: Hellenic S/R Ltd., (01) 721 1140

Hong Kong: Euro Tech (Far East) Ltd,
(052) 814-0311

India: Electronic Ent, (022) 4137096

Israel: Ammo, (03) 453157

Italy: LeCroy Srl, Roma (06) 300.97.00
or 331 31 46; Milano (02) 2940 5634

Japan: LeCroy Japan,
Tokyo (0081) 33 376 9400;
Osaka (0081) 6 330 0961

Korea: WOOJOO Hi-Tech Corp,
(02) 449-5472

Mexico: Nucleoelectronica SA,
(05) 5593 6043

New Zealand: E.C. Gough Ltd,
(03) 798-740

Norway: Avantec AS (02) 630520

Pakistan: Electronuclear Corp, (021) 418087

Portugal: M.T. Brandao, Lta, (02) 815680

Singapore: Sing. Electr. and Eng. Ltd
(65) 481-8888

S. Africa: Westplex Test & Meas.
(011) 787 0473

Sweden: MSS AB, (0764) 68100

Switzerland: LeCroy SA (064) 51 91 81

Taiwan: Topward El.Inst., Ltd, (02) 601 8801

Thailand: Measuretronix Ltd, (02) 374 2516

United Kingdom: LeCroy Ltd, (0235) 533 14

LeCroy

Innovators in Instrumentation

LeCROY CORPORATE HEADQUARTERS

700 Chestnut Ridge Road
Chestnut Ridge, NY 10977-6499
Phone: (914) 425-2000
TWX: (710) 577-2832
Fax: (914) 425-8967

LeCROY EUROPEAN HEADQUARTERS

2, rue du Pré-de-la-Fontaine
P.O.Box 341
1217 Meyrin 1 - Geneva, Switzerland
Telephone: (022) 719-21-11
Fax: (022) 782-39-15

SECTION 3	Block Diagram and Sub-Assemblies
------------------	---

3.1 9314A Sub-Assemblies

F9314M-1	Processor, 2 Mbyte RAM (DSO's manufacturing date < 19/08/94)
or F9300-1-2	Processor, 2 Mbyte RAM (DSO's manufacturing date > 19/08/94)
F9314A-3	Main card, quad 400 MHz, 100 MS/s, 50 Kb, Frontend, ADC, TDC
F9300-4	GPIB + RS232 interface
F9354-5	Quad channel front panel
93XX-PS1715	Power supply +/- 5V, +/- 15V.
93XX-Display	Video, deflection, CRT, yoke
M93XXA	Mechanical for 93XXA series

3.2 9314AM Sub-Assemblies

F9314M-1	Processor, 2 Mbyte RAM (DSO's manufacturing date < 19/08/94)
or F9300-1-2	Processor, 2 Mbyte RAM (DSO's manufacturing date > 19/08/94)
F9314AM-3	Main card, quad 400 MHz, 100 MS/s, 200 Kb, Frontend ADC TDC
F9300-4	GPIB + RS232 interface
F9354-5	Quad channel front panel
93XX-PS1715	Power supply +/- 5V, +/- 15V.
93XX-Display	Video, deflection, CRT, yoke
M93XXA	Mechanical for 93XXA series

3.3 9314AL Sub-Assemblies

F9314M-1	Processor, 2 Mbyte RAM (DSO's manufacturing date < 19/08/94)
or F9300-1-2	Processor, 2 Mbyte RAM (DSO's manufacturing date > 19/08/94)
F9314AL-3	Main card, quad 400 MHz, 100 MS/s, 1 Mb, Frontend, ADC, TDC
F9300-4	GPIB + RS232 interface
F9354-5	Quad channel front panel
93XX-PS1715	Power supply +/- 5V, +/- 15V.
93XX-Display	Video, deflection, CRT, yoke
M93XXA	Mechanical for 93XXA series

3.4 9314A, 9314AM and 9314AL Hardware Options

9314-FDGP	Graphic Printer & Floppy Disk F9300-6 : Centronics, Floppy, Printer interface F9300-7 : Printer controller
9314-GP01	Graphic Printer F9300-6 : Centronics, Floppy, Printer interface F9300-7 : Printer controller
9314-FD01	Floppy Disk F9300-6 : Centronics, Floppy, Printer interface

Section 3 Block Diagram and Sub-Assemblies

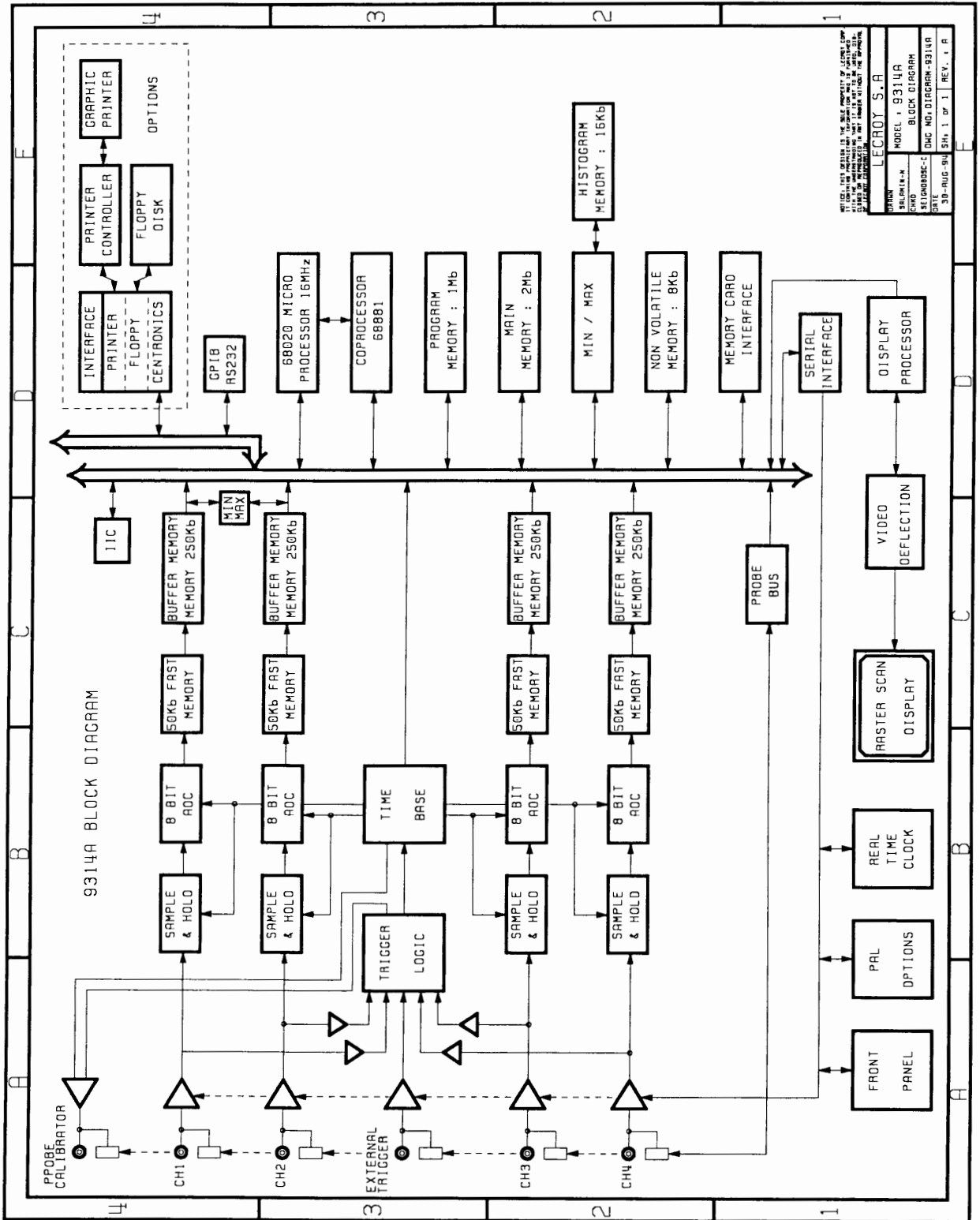

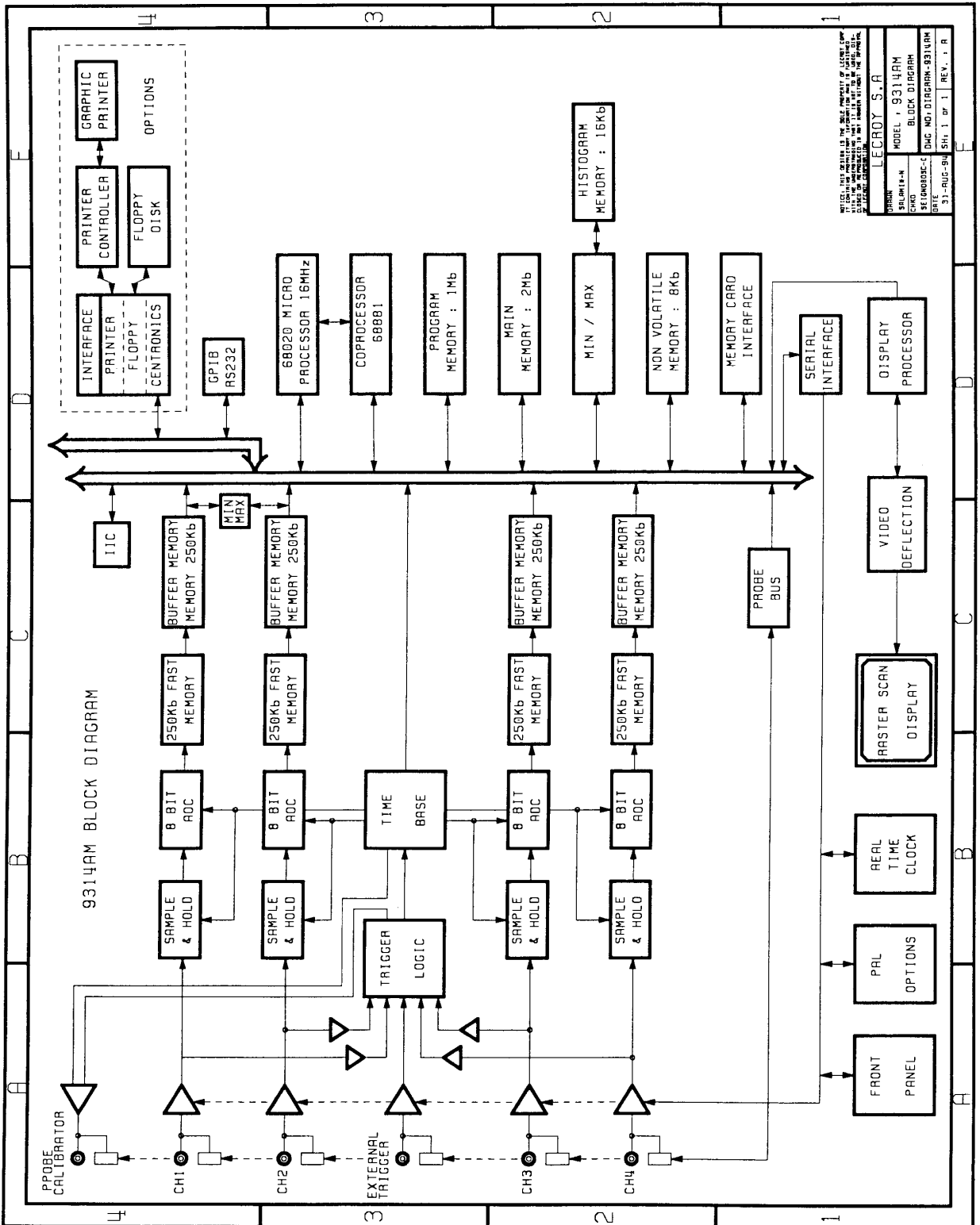

Section 3 Block Diagram and Sub-Assemblies

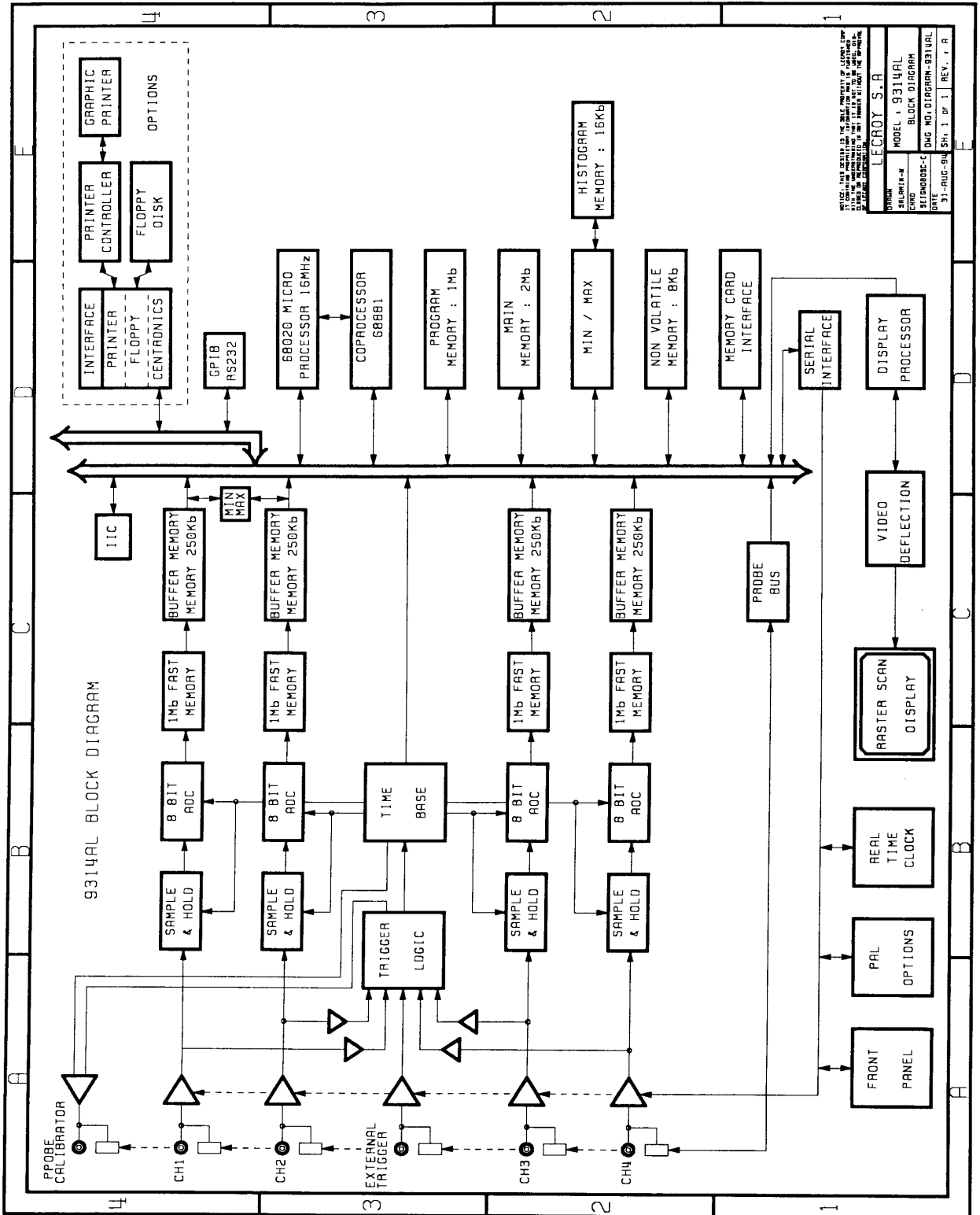

THIS DOCUMENT CONTAINS THE BASIC PRINCIPLES OF OPERATION OF THE INSTRUMENT. IT IS NOT TO BE USED AS A REFERENCE FOR THE INSTRUMENT'S OPERATION. FOR MORE INFORMATION, CONTACT THE INSTRUMENT MANUFACTURER.

ORIGIN	LECROY S.A.
REVISION #	MODEL 9314AL
DATE	BLOCK DIAGRAM
	SET 9314005E-C
	DWG NO. DIAGRAM-9314AL
	DATE 31-AUG-94 SH. 1 OF 1 REV. 1 A

SECTION 4 THEORY of OPERATION

4.1 Processor Board : F9314M-1 or F9300-1-2 for 9314A, 9314AM and 9314AL

This processor board is based on to the 68020 and 68881 coprocessor, with an internal clock frequency of 16 MHz, and 2 Mbytes RAM memory. The peripheral Data Bus set 8 or 16 bits, the Address Bus has 27 bits (A0-25 & A31).

Program memory (EPROM)

1 Mbytes	: 4 x 2 Mbit Eproms or 2 x 4 Mbit Eproms
Data Bus	: 16 bits.
Address	: 0000 0000 to 000D FFFE.

Working memory (PS RAM)

2 Mbytes memory	: 4 Pseudo static RAM of 4 Mbit.
Data Bus	: 16 Bits.
Address	: 0040 0000 to 004F FFFE or 005F FFFE.

Non volatile memory

A static RAM of 8 Kbytes contains the parameters used at power on to initialize the scope and the stored parameters (panels). This memory is battery backed up.

4.1.1 Parallel Peripherals

F9314A/M/L-3 main board interface : Data bus 16 bits.

The main board is connected to the processor via a 32 bits address bus.
See section 4.2.

Min/Max calculation : Data bus 16 bits.

A gate array MNX401 makes a histogram in its associated 16 Kbytes memory and remembers the minimum and maximum data values it sees.

Memory card : Data bus 8 bits.

An interface is implemented to support an external memory card, PCMCIA / JEIDA 4, type 68 pins, whose size can range from 16 Kbytes to 4 Mbytes, with the extension to support flash memory and I/O cards.

Graphic processor : Data bus 8 bits.

The graphic processor of the raster scan display is a gate array designated MDS410.

Clock frequency	: 48 MHz.
Trace and characters memory	: 32 Kbytes (SRAM).
Bitmap memory	: 128 Kbytes (BMRAM).
Character font	: 32 Kbytes (SRAM).

DAC command of the display intensity : Data bus 8 bits.

The control of the display intensity is done by a RAMDAC, up to 8 traces.

Status and command registers : Data bus 8 bits.

Status (read) and command (write) registers of 12 bits address, control the memory card and front panel interface during the boot process or after a RESET.

4.1.2 Processor Block Diagram

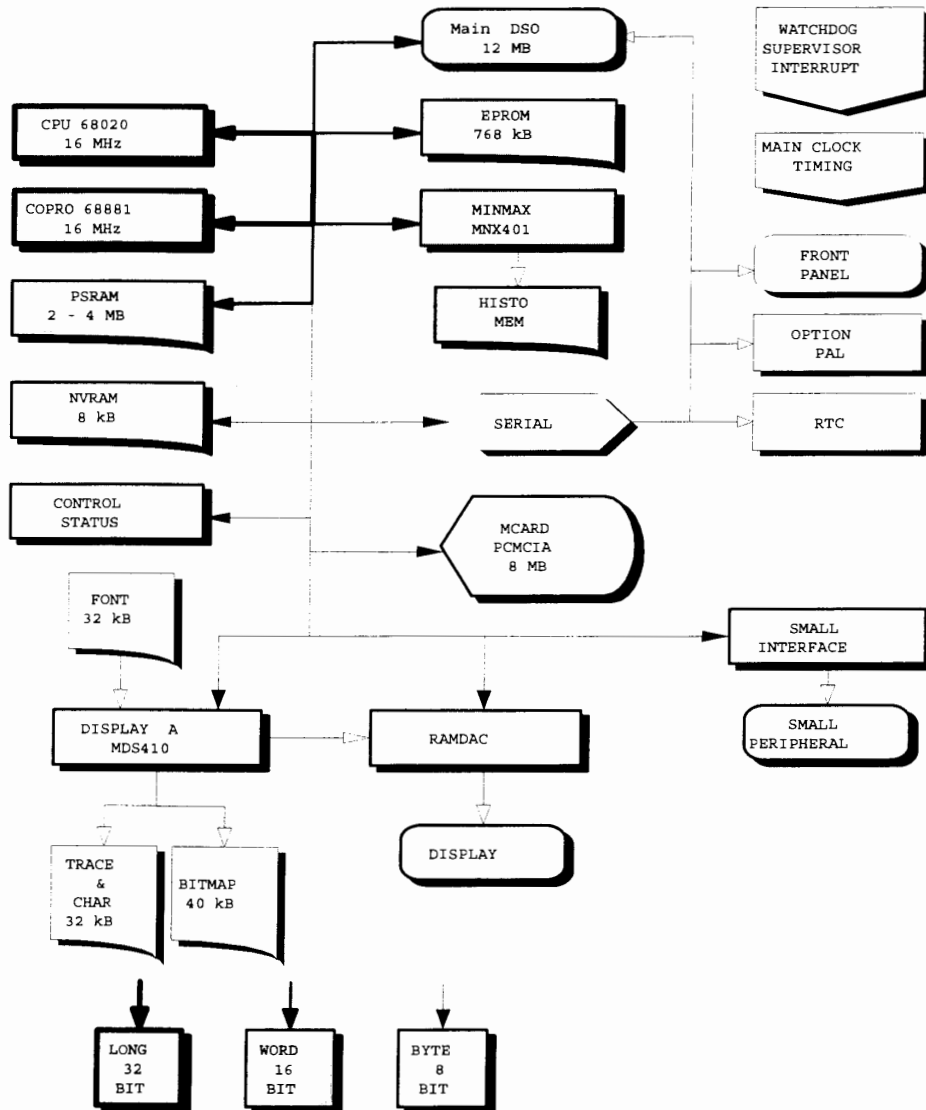

4.1.3 Serial Peripherals

The processor controls the digital and analog section with a dual serial controller.

DAC's registers (read/write)
 Front panel registers (68HC05C4)
 RTC registers (68HC68T1)
 Probe detection
 Software options (GAL)
 Front end control
 Trigger control (MTR408)

Real time clock

Integrated circuit 68HC68T1 (Motorola or RCA).
 Resolution : 1 sec to 99 years.
 Clock frequency : 32.768 KHz.
 Non volatile memory : 32 Kbytes.
 Data & Address bus : 8 bits.
 Interrupt level : 5.

4.1.4 External Interfaces

Serial RS232 interface and Parallel GPIB interface : See F9300-4 description, section 4.3.

4.1.5 Optional Interfaces

Graphic Printer : F9300-6 interface and F9300-7 printer controller.
 Floppy Disk Drive : F9300-6 interface
 Centronics Printer : F9300-6 interface
 Hard Disk : F9300-8 interface

4.2 F9314A/M/L-3 Main Board

4.2.1 Introduction

The board is divided into five sections :

- Microprocessor control.
- Front-end
- Trigger
- Analog to Digital Converter
- Time base

4.2.2 Front End

The front end system provides the signal conditioning for the ADC system.
 The main functions are :

- four channels operation, calibration with Software control
- input protection and coupling : AC, DC, 1 M Ω , 50 Ω
- amplitude normalisation for the ADC system : 320 mV full scale
- fine gain control
- offset control
- bandwidth limit filter : BWL 30 MHz
- triggering with standard coupling and TV trigger on two channels and External

4.2.2.1 Channel Description

The four channels are identical, thus only one channel will be described for brevity.

- Input coupling and protection : Relay RL1 (RECAL) connects the front-end input to the calibration source and disconnects the BNC which is then terminated on a 1 M Ω high impedance. Switch SW1 (VCAL/10) selects between a divide by 4 or a divide by 40 for the DC calibration signal. Relay RL2 (RE50) sets the 1M Ω /50 Ω coupling.

A diode circuit senses the temperature of the 50 Ω termination resistor and sets the _OVL status bit low if overheating is detected. The BNC input is then disconnected by the hardware, the DC calibration signal being connected to the front-end input (automatic activation of RL1).

Relay RL3 (_IN/20) selects between a divide-by-20 or a direct path for the signal.

Relay RL4 (REAC) sets the AC/DC coupling, which is preceded by a divide by 10 amplifier.

- High impedance buffer : A0 is a high impedance buffer with a gain of 10. The same buffer is used for the offset control. Switch SW2 (of/10) selects a direct or a divide by 10 amplifier.

- The MFE409 is a monolithic circuit with the following main features :

- Differential input with 6 fixed sensitivities (2 mV/div. to 100 mV/div. in a 1-2-5 sequence).

- Continuously variable gain amplifier with gain ratio of almost 3.5.

- A2 is a second variable gain amplifier used to reach the gain needed for the 2 mV/div. setting.

▪ A3 delivers two complementary outputs, one for the ADC system and one for the trigger circuit (MTR408). A3 can be trimmed for gain and linearity. Typically, A1 will be set with 20 mV/div. and a gain of 3.0, A2 with a gain of 2.0 and A3 will be trimmed to have 320 mV FS into the ADC system input with the lowest non-linearity.

- The bandwidth control, connected through switch SW3 (BWL), is implemented with a one pole RC filter with a -3 dB cut-off frequency of almost 30 MHz.

▪ Another bandwidth control, connected through switch SW4 (BWLD), is here to correct the shape of the signal when the divide-by-20 attenuation is selected (gain > 100 mV) in 1 M Ω high impedance coupling.

4.2.3.2 Digital controls

Send by the processor in a 16 bits word.

Address : 0141 0000 write channel 1 control register
 0141 1000 write channel 2 control register
 0141 2000 write channel 3 control register
 0141 3000 write channel 4 control register

15								8
_VCAL	_IN/20	2mV	5mV	10mV	20mV	50mV	100mV	
7								0
---	---	BWL			OF/10	DC	_HZ	

range mV	OF/10	_IN/20	2mV	5mV	10mV	20mV	50mV	100mV	gain to ADC
2	1	1	1	0	0	0	0	0	+20
5	1	1	0	1	0	0	0	0	+8
10	1	1	0	0	1	0	0	0	+4
20	0	1	0	0	0	1	0	0	-2
50	0	1	0	0	0	0	1	0	-0.8
100	0	1	0	0	0	0	0	1	-0.4
200	1	0	0	0	1	0	0	0	+0.2
500	0	0	0	0	0	1	0	0	-0.08
1000	0	0	0	0	0	0	1	0	-0.04
2000	0	0	0	0	0	0	0	1	-0.02

_VCAL 0 = DC calibration (external BNC is disconnected),
 1 = input coupling.
 IN/20 0 = attenuation is ON, 1 = attenuation is OFF.
 BWL 0 = bandwidth limit is OFF, 1 = bandwidth limit is ON.
 OF/10 0 = offset control attenuation is OFF, 1 = ON.
 DC 0 = AC coupling, 1 = DC coupling.
 _HZ 0 = 1 M Ω high impedance coupling, 1 = 50 Ω coupling.

0140 4000 - 0140 40ff read channels overload

7							0
_INTWD	_INTIC	_OVL_T	PPOFF	_OVL_4	_OVL_3	_OVL_2	_OVL_1

_INTWD watchdog ADC interrupt,
 _INTIC I²C protocol interrupt,
 _PPOFF probe power overload interrupt,
 _OVL_n overload indicator (Ch 1, 2, 3, 4).

A low state indicate that overload or interrupt is detected.

0140 5000 - 0140 50ff read overload sum

OVLSUM bit 5, 0 = OK, 1 = problem occurred (read channels overload)

4.2.3.3 Analog controls

- One precision DAC with associate circular memory (μP system) drives and refreshes a multiple sample-and-hold system. The DC calibration control is common to all channels. Each channel has two analog controls.
- VCAL and VOFFSET are voltage controls. The DAC dynamic range ($\pm 10V$) is scaled to the proper range by means of resistor dividers and thus the conversion can be said to be linear. The gain controlled amplifiers inside the MFE409 needs current mode controls. A voltage to current converter follows the sample-and-hold IVGAIN signal and provides the appropriate range. The addresses are :

```

0300 0014 write DC calibration level control (VCAL)
0300 0000 write channel 1 gain control
0300 0002 write channel 1 offset control
0300 0004 write channel 2 gain control
0300 0006 write channel 2 offset control
0300 0008 write channel 3 gain control
0300 000a write channel 3 offset control
0300 000c write channel 4 gain control
0300 000e write channel 4 offset control
    
```

4.2.4 Trigger

The different trigger couplings are :

- DC
- AC : cut off frequency is almost 10 Hz.
- LF REJ : set a single pole high pass filter with a cut off frequency at 50 kHz.
- HF REJ : set a single pole low pass filter with a cut off frequency at 50 kHz.
- TBWL : single pole low pass filter at 30 MHz.

The amplitude at the input of the MTR408 is 320 mV FS (identical to the ADC system),

4.2.4.1 Digital Controls

The 40 bit shift register, is allocated as follows : 0141 4000 - 0141 40ff write trigger control register

39	---	TBWL_1	HFR_1	AC_1	DC_1	---	SNEG_1	SPOS_1	32
31	TEXT50	TBWL_2	HFR_2	AC_2	DC_2	---	SNEG_2	SPOS_2	24
23	---	TBWL_3	HFR_3	AC_3	DC_3	---	SNEG_3	SPOS_3	16
15	---	TBWL_4	HFR_4	AC_4	DC_4	---	SNEG_4	SPOS_4	8
7	EXT/10	TBWL_EXT	HFR_EXT	AC_EXT	DC_EXT	---	SNEG_EXT	SPOS_EXT	0

TEXT50 0 = 1 M Ω external input coupling, 1 = 50 Ω external input coupling.
EXT/10 0 = attenuation is ON, 1 = OFF.

4.2.4.2 Analog Controls

A sample and hold fed by the precision DAC provides the threshold level.

The addresses are :

0300 0010 write EXT threshold control
 0300 0018 write channel 1 threshold control
 0300 001a write channel 2 threshold control
 0300 001c write channel 3 threshold control
 0300 001e write channel 4 threshold control

4.2.4.3 TV Trigger

Each channel has a pick-off after the MFE409 or after the high impedance buffer for external trigger. The TV trigger source is selected via bit TVS and drives a times 10 amplifier with complementary outputs. These outputs are selected (_TVINV) depending on the state of the selected MFE409 gain.

The TV trigger uses a commercial chip (LM1881) and provides two outputs, TV1 & TV2. This circuit is able to trigger on different TV line number standards.

▪ Digital Controls

The 16 bit shift register, written using the serial protocol, is allocated as follows :

0141 5000 - 0141 50ff write trigger TV and MST412 oscillator control register

15	8
_TVINV	MA
TVS2	TVS1
TVS0	HDTV
875	MB
---	---
---	---
7	0
_STI	_STW
_SVS	_STS
---	---

_TVINV 0 = inverting TV trigger (to compensate for inversion in MFE409).
 _SVS 0 = enable TV1 source.
 _STS 0 = enable TV2 source.
 _STI 0 = enable interval width mode for MST412 oscillator control.
 _STW 0 = enable pulse width mode for MST412 oscillator control.

TVS2	TVS1	TVS0	TV trigger source	HDTV	875	line setting
0	0	1	channel 1	0	0	525-625 TVLO
0	1	0	channel 2	0	1	875 (MED)
0	1	1	channel 3	1	0	1225 (HIGH)
1	0	0	channel 4	1	1	2500 (HDTV)
1	0	1	external trigger			

4.2.5 Analog to Digital Converter

4.2.5.1 Introduction

The analog to digital converter system does the signal conversion to 8 bits.

- Sample and Hold : the HSH410 Hybrid performs the track and hold before the ADC.
- Flash ADC : the SP975088 is a flash ADC working at a maximum clock speed of 100 Ms/s.
- Demultiplexer : the MDX407 monolithic is used to demultiplex the ADC output.
- ADC Memory : 50K points for 9314A, 200K for 9314AM, 1M points for 9314AL
- Buffer Memory : 250K bytes

4.2.6 Time Base

4.2.6.1 Introduction

The 100 MHz main clock is directly used by the sample-and-hold, the analog-to-digital converter and the time-to-digital converter for real time measurement. It is also used for synchronization inside the MDX407 demultiplexer. The main clock can also be driven from the external trigger BNC, this path is selected by a control bit (SEXTCK).

4.2.6.2 Trigger Selection

A logical function of the TCx signals can be selected (bit STCx) for the pattern generator. A few single ended signals can also be selected one at a time (bit STn). These signals are TV1 and TV2 for television trigger, TRT for test and calibration of MST412, _VALOUT for drop-out trigger.

Then there is a selection between the pattern and the single ended sources (bit SPAT). The signal obtained is inverted (bit INVPAT) and used to drive TRCKL (bit STRCKL). There is also a choice between this signal and TV1 to drive VALCKL (bit SVAL0). The pattern trigger logic function is any "AND" combination of TCx input signals, inverted or not.

All the control are done through a 16 bit serial register.

4.2.6.3 Smart Trigger

The VALCKL source drives the MST412. The TRCKL source goes through a buffer to drive the MST412 and control the smart trigger 400 MHz start/stop oscillator.

The MST412 oscillator is usually free running, but when using glitch trigger mode the oscillator is enable only during the pulse duration (bit _STW), and when using interval width trigger mode the oscillator is restarted at each edge (bit _STI).

There is also a time base mode control register with roll mode interrupt enable (RMIE), external clock control (SEXTCK, EXTCTH1 and EXTCTH2), buzzer (BUZZ) and calibration front panel output signal selection (PCSn).

4.3 F9300-4 GPIB and RS 232 Interface

This board is connected to the processor through a flat cable.
Data bus is 8 bits, address bus: 12 bits.
Address 0180 000 to 0180 00FF.

4.3.1 RS 232 Serial Interface

Based on the 2661A IC from Signetics or Philips.

- Clock frequency 4.9152 MHz.
- 4 internal registers of 8 bits.
- Interrupt level 2.
- Connector type DB9 with 9 male pins.

4.3.2 GPIB Interface

Based on the circuit 7210 IC from NEC.

- Clock frequency 5 MHz.
- 8 internal registers of 8 bits.
- Tri-state external GPIB drivers. - Low level output.
- Interrupt level 3.

The GPIB address is set by software and stored in non-volatile memory.

4.4 F9354-5 Front Panel

The front panel is connected to the processor board with a flat cable. Power supply and control signals are supplied from the processor. The front panel is divided in two sections:

- One board with Motorola 68HC05C4 processor, coders, and serial data interface.
- One matrix Keyboard with push buttons.

4.5 F9300-6 Centronics, Floppy, Printer interface option

4.5.1 Centronics interface option

This Centronics interface makes direct connection possible to external parallel printer.

- Address 0130 0180 to 0130 01A0
- Interrupt level 2

4.5.2 Floppy Disk drive interface option

Based on the circuit MCS3201 from Motorola.

- Address 0130 01C0 to 0130 01C7
- Interrupt level 4

Address	Read	Write
0130 01C0	Input register	-----
0130 01C2	-----	Digital output register
0130 01C4	Main status register	-----
0130 01C5	Data register	Data register
0130 01C7	Data input register	Disk control register

4.5.3 Printer Interface option

Internal graphic printer : Seiko LPT5446

- Address 0130 0140 to 0130 0160
- Interrupt level 2

4.6 F9300-7 Printer Controller option

Based on the LPT5000 series control chip set from Seiko instrument Inc

- PT501P01 CPU
- PT500GA1 Gate array
- Technical reference 39019-2234-01
- Address 0130 0100

4.7 93XX-Display

4.7.1 General Description

The raster scan display module is divided into five sections:

- Graphic processor
- Deflection
- Video
- Yoke
- Cathode ray tube

4.7.2 Basic Characteristics

- Nine inches diagonal monochrome, yellowish, orange.
- CRT anti-glare treated
- Non interlaced resolution of (X)810 x (Y)696 pixels at 60 Hz or 50 Hz frequency.
- Landscape vertical raster
- Electromagnetic deflection.
- Intensity control rise and fall time > 12 ns.
- Analog intensity input
- TTL synchronization input.

- Horizontal nominal size: 165 mm for X-on = 15.39 Ms.
- Horizontal size adjustment: > +/- 5 mm.
- Horizontal offset adjustment: +/- 5 mm.
- Vertical nominal size: 120 mm for Y-on = 14.5 μ s.
- Vertical size adjustment: > +/- 5 mm.
- Vertical offset adjustment: +/- 5 mm.
- X and Y differential non linearity: 10%.

The line deflection is vertical, from bottom to top. The field deflection is horizontal, from left to right and is resynchronized to the power line frequency.

4.7.3 Horizontal Deflection

The horizontal deflection is synchronized to the 50 or 60 Hertz power line frequency. The on time display is the same for both frequencies, therefore the deflection is calculated for 60 Hz. The horizontal deflection is controlled by the HSYNC signal.

The trailing edge of HSYNC resets the horizontal spot position to a hardware predefined position at the left side of the screen: MAX_left. When ever HSYNC is high, the spot stays at this position.

The falling edge of HSYNC starts the horizontal deflection ramp. The ramp has the same rate for either 50 or 60 Hertz frequency.

When ever HSYNC is low, the horizontal deflection will rise left to right, until HSYNC becomes high, or the system has reached the maximum right position (MAX_RIGHT).

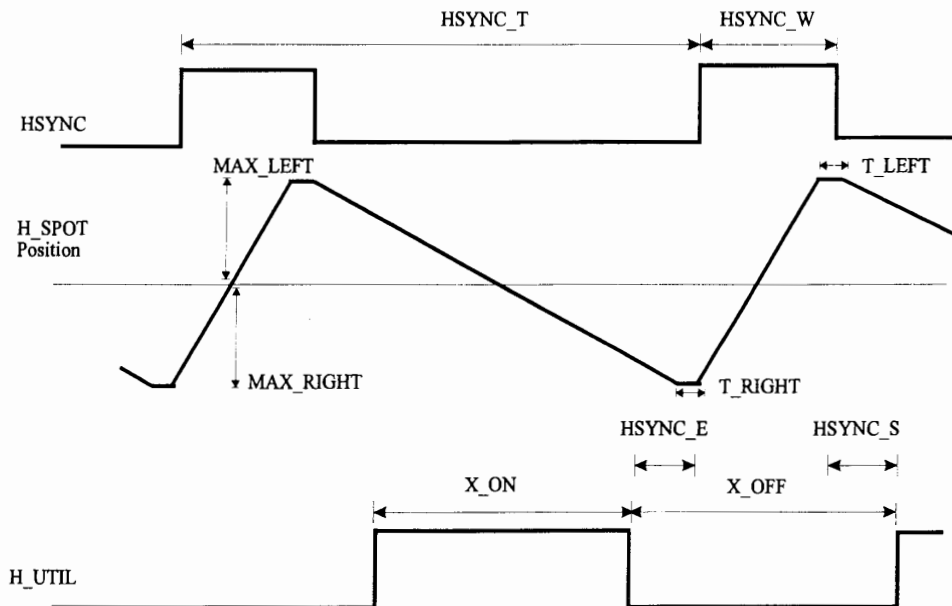

4.7.4 Vertical Synchronization

The timing of both VSYNC and HSYNC is synchronized to the pixel clock (PCLK).

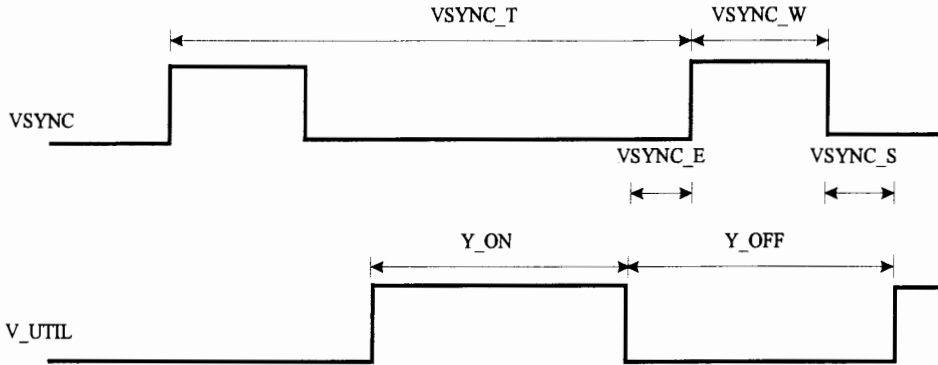

The pixel rate is 48 MHz.

4.7.5 Horizontal Resolution

	# of vertical line	Time in ms
HSYNC_T	842	15.998
HSYNC_W	22	0.418
HSYNC_E	4	0.076
HSYNC_S	6	0.114
X-ON	810	15.390
X-OFF	32	0.608

Values of the horizontal timing for the maximum field refresh frequency.

4.7.6 Vertical Resolution

	# of Pixels	Time in μ s
VSYNC_T	912	19.000
VSYNC_W	136	2.833
VSYINC_E	0	0.000
VSYINC_S	80	1.666
Y-ON	696	14.500
Y-OFF	216	4.500

4.8 93XX-PS1715 Power Supply

4.8.1 Power Supply Specifications

Input voltage	: 90 to 130 V or 180 to 250 V. Auto ranging line voltage.
Input frequency	: 45 Hz to 66 Hz.
Input rush current	: Max. 40 A peak at start up.
Environmental	: Operating temperature range 0 °C to + 55 °C Storage temperature range - 55 °C to + 85 °C Relative humidity from 5% to 95%.
Output voltages	: - 5.2 VDC, 8 amp Max. + 5.1 VDC, 4.5 amp Max. - 15 VDC, 4.5 amp Max + 15 VDC, 4.5 amp Max.
Output adjustment	: +/- 5%.
Regulation	: +/- 1%.
Transient response	: -5.2 V < 400 mV +5.2 V < 250 mV +/-15.1 V < 1.5 V Maximum recover time 1.5 msec
Ripple and noise	: Peak to peak value < 1% Line frequency rejection < 5mV
Hold up time	: 20 msec at full load
Overshoot	: < 5% at start up
Output short circuit protection	: Yes.
Output over voltage protection	: No.
Input protection	: 5 amp fuses.
Thermal protection	: Yes.
Shock vibration	: MIL-STD-810D MIL-T-28000C, para 4.5.5.4.2
Safety	: VDE 0806, IEC 380, 435, 950 & UL1012, 478, CSAC22.2#1402C
EMI	: VDE 0871 class A, FCC 20780 class A.

4.8.2 Power Supply Block Diagram

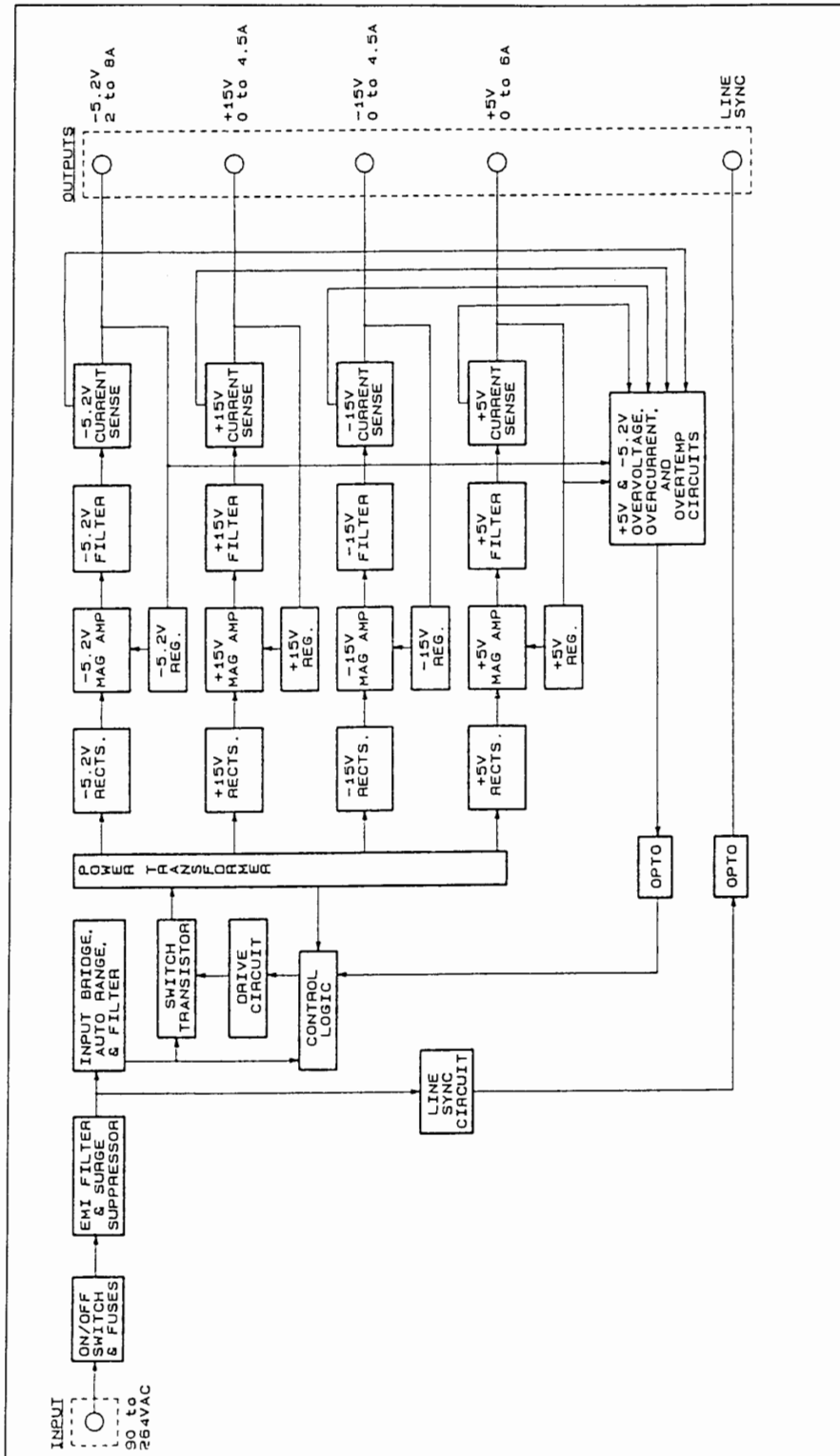

SECTION 5 Performance Verification

5.1 Introduction

This procedure can be used to verify the main operating specifications of the LeCroy 9314A/M/L digital storage oscilloscope, it is useful as a calibration verification procedure, as well as an incoming inspection checkout. It is time consuming and requires extensive test equipment. If you are not familiar with operating the 9314A/M/L oscilloscope, read the operator's manual.

5.2 Test Equipment Required

Instrument	Qty	Specifications	Recommended	Where used
Signal Generator (sine wave)	1	Frequency : .5 MHz to 1 GHz Frequency Accuracy : 1 ppm Amplitude : 1 V peak to peak	Marconi 2030 or equivalent	5.9.1.a 5.11 5.12
Leveled Sine wave generator	1	Frequency : .5 MHz -250 MHz Amplitude : 5 V peak to peak	Tektronix SG503 or equivalent	5.9.1.b
Fast pulse Generator	1	Rise time < 500 psec	LeCroy 4969 or equivalent	5.13
Sine Wave Generator	1	Frequency : 5 KHz Amplitude : 6 V peak to peak	any Generator	5.10
DC precision Power Supply	1	Amplitude : 10 V, DC Accuracy : < 0.1 %	Tektronix PS5004	5.7, 5.8 5.15
Digital Multimeter	1	4 digits	Keithley 199 or equivalent	5.4 5.5
Cable	1	BNC, 50 Ω , length 20 cm, 1ns (7.87 inches)	LeCroy 4802432001	5.10.3 5.10.4
Cable	1	BNC, 50 Ω , length 100 cm, 5 ns (39.37 inches)	LeCroy 480020101	5.XX
Attenuator	1	50 Ω , 20 dB, 1% accuracy	Suhner	5.7
Attenuator	1	1 M Ω , 20 dB, 1% accuracy	Suhner	5.7
Attenuator	1	50 Ω , 3 dB, 1% accuracy	Suhner	5.10
Terminator	1	50 Ω Feed through	Suhner	5.13
BNC T adapter	1	BNC, 50 Ω , T adapter	LeCroy 402222002	5.10.3 5.10.4

Table 5-1 : Test Equipment**5.3 Turn On**

- Switch on the power using the power switch on the rear panel and verify :
- The display turns on after about 10 seconds and is stable
- The range of intensity and grid intensity is reasonable
- Wait for about 10 minutes for the scope to reach a stable operating temperature.

5.4 Input Impedance

Specifications

DC $1\text{M}\Omega \pm 1\%$
 DC $50\ \Omega \pm 1\%$

5.4.1 Procedure

The input impedance is tested in working conditions, with a high precision digital multimeter.

5.4.1.a DC $1\text{M}\Omega$

- Set DSO Channel 1 : **On**
- Input Coupling : **DC $1\text{M}\Omega$**
- Input gain : **100 mV/div.**
- Trigger on : **Channel 1**
- Trigger mode : **Auto**
- Time base : **50 $\mu\text{sec/div.}$**

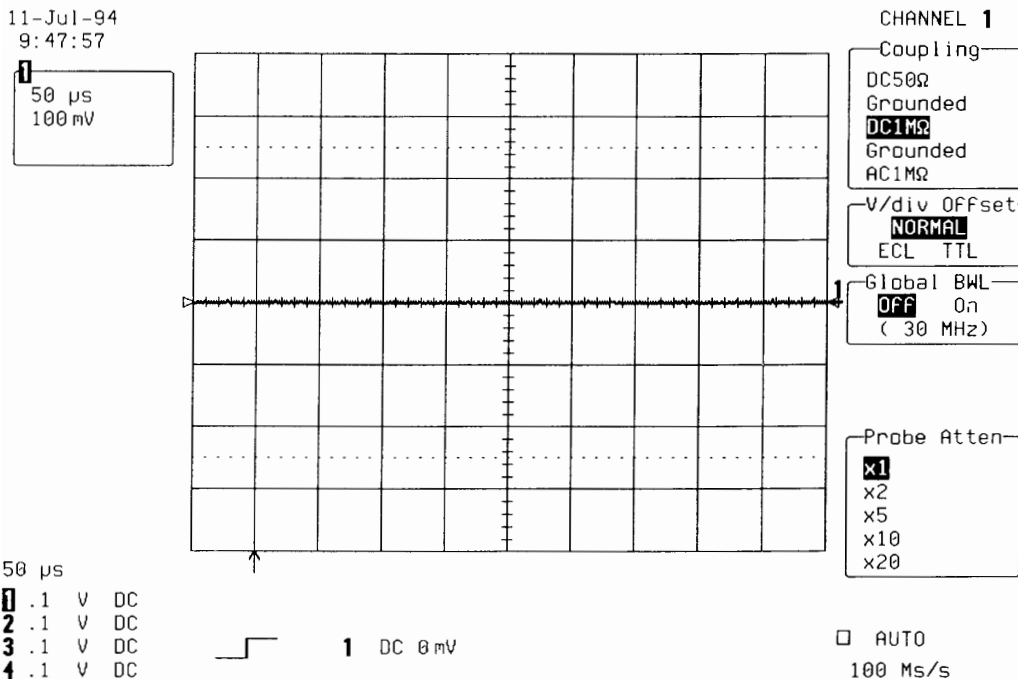

- Measure the impedance using a high precision DMM with sense : must be **$1\text{M}\Omega \pm 1\%$** .
- Repeat the above test for input volt/div. of **200 mV**.

5.4.1.b DC 50Ω

- Set DSO Channel 1 : **On**
- Input Coupling : **DC 50Ω**
- Input gain : **100 mV/div.**
- Trigger on : **Channel 1**
- Trigger mode : **Auto**
- Time base : **50 μsec/div.**

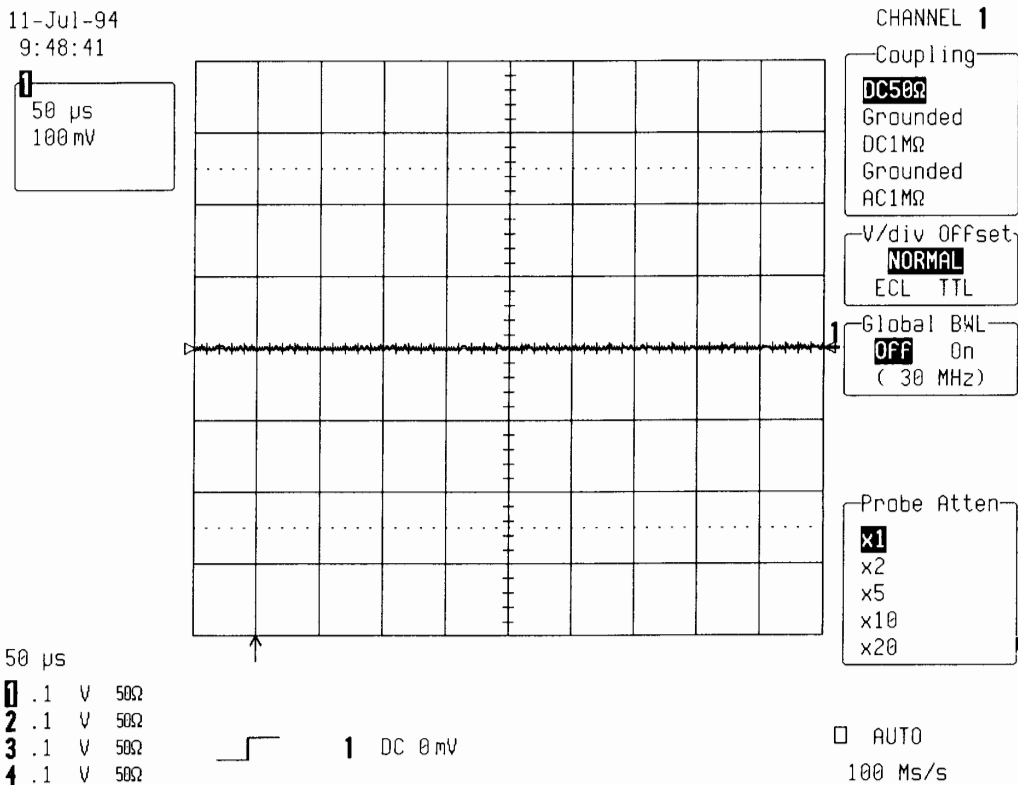

- Measure the impedance using a high precision DMM with sense : must be **50 Ω ± 1%**
- Repeat steps 5.4.1.a, and 5.4.1.b for Channel 2, Channel 3 and Channel 4.

5.4.2 External Trigger Input Impedance

5.4.2.a DC 1MΩ

The External Trigger input impedance is tested with any time base and gain.

- Set Trigger on : EXT
- Trigger mode : Auto
- Coupling Ext : DC
- External : DC 1MΩ

11-Jul-94
9:49:51

50 μs
100 mV

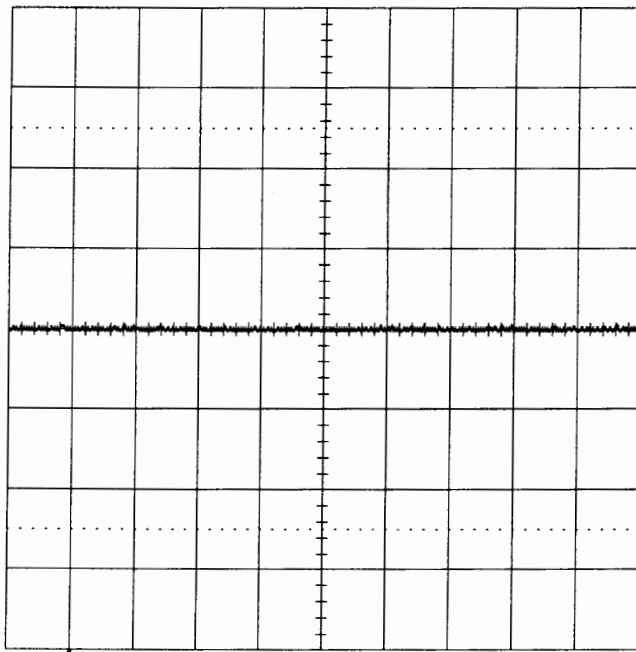

TRIGGER SETUP

Edge SMART

trigger on
1 2 3 4 Ext
Ext10 Line

cplg Ext
DC AC LFREJ
HFREJ HF

slope Ext
Pos Neg
Window

External
atten x1
DC50Ω DC1MΩ

holdoff
- - -
OFF Time Evts

50 μs

- 1 .1 V 50Ω
- 2 .1 V 50Ω
- 3 .1 V 50Ω
- 4 .1 V 50Ω

Ext DC 0mV 1MΩ

AUTO
100 Ms/s

- Measure the impedance using a high precision DMM with sense : must be 1MΩ ±1%.

5.4.2.b DC 50Ω

With any time base and gain.

- Set Trigger on : **EXT**
- Trigger mode : **Auto**
- Coupling Ext : **DC**
- External : **DC 50Ω**

11-Jul-94
9:50:18

50 μs
100 mV

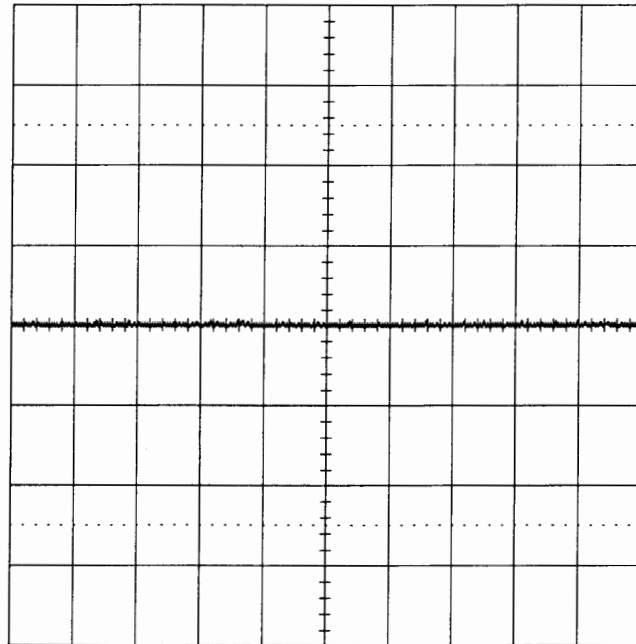

TRIGGER SETUP

Edge SMART

trigger on
1 2 3 4 Ext
Ext10 Line

cplg Ext
DC AC LFREJ
HFREJ HF

slope Ext
Pos Neg
Window

External
atten x1
DC50Ω DC1MΩ

holdoff
Off Time Evts

50 μs

- 1 .1 V 50Ω
- 2 .1 V 50Ω
- 3 .1 V 50Ω
- 4 .1 V 50Ω



Ext: DC 0mV 50Ω

AUTO
100 Ms/s

- Measure the impedance using a high precision DMM with sense : must be **50 Ω ± 1%**.
- Repeat steps 5.4.2.a, 5.4.2.b for **Ext/10**, and check as above.

5.4.3 Internal Protective Resistor Verification

With any time base and gain, set DSO as follows :

- Input Coupling : **Grounded**
- Check with a high precision DMM : input impedance must be **1 MΩ ± 2%**.
- In case of problem check SM 1MΩ resistor R1004, troubleshoot relay RL1000 .
- Repeat the above test for Channel 2, Channel 3 and Channel 4.
- In case of problem check SM 1MΩ resistors R2004, R3004, R4004 or troubleshoot relays RL2000, RL3000, RL4000.

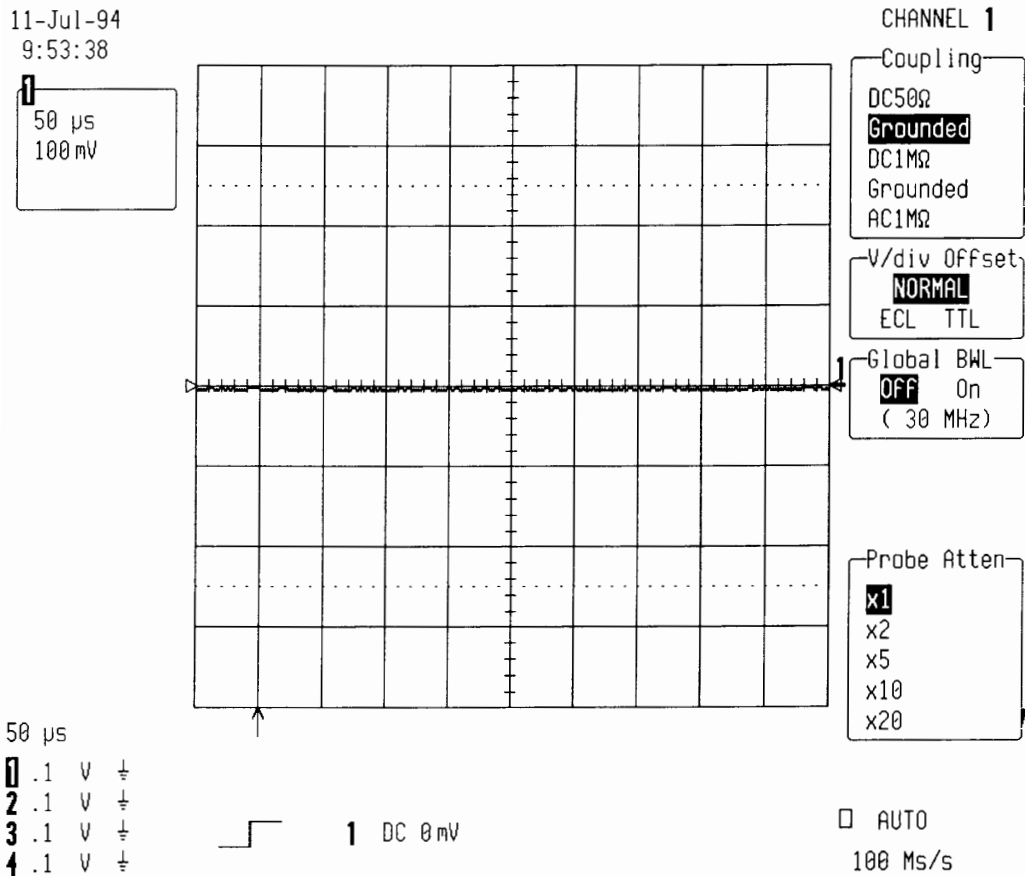

5.5 Leakage Current

Specifications

DC 1 M Ω , AC 1 M Ω , DC 50 Ω : ± 1 mV

5.5.1 Procedure

- Set DSO Ch1 : **On**
- Input Coupling : **DC 50 Ω**
- Input gain : **100 mV/div.**
- Trigger on : **Channel 1**
- Trigger mode : **Auto**
- Time base : **10 μ sec**

- Connect a high precision DMM to Channel 1, and verify that the reading is not larger than ± 1 mV.

- Repeat the procedure for **1M Ω DC** and **1M Ω AC**.

- Repeat step 5.5.1 for Channel 2, Channel 3, Channel 4 and check as above.

5.6 Average Noise Level

Description

The 9314A/M/L inputs average noise level is tested at 5 mV/div., with 0 mV offset. This is to verify the proper operation of the main board, front-end and ADC's. The scope parameters functions are used to measure the RMS and Peak amplitude of the noise.

5.6.1 Peak to Peak Noise

Specifications

< ± 3.6 mV Peak to Peak at 5 mV/div.

5.6.1.a DC 1M Ω

Procedure

- With no signal connected to the inputs, set 9314A/M/L DSO settings as follows :

- Turn on trace : **Ch1, Ch2, Ch3, Ch4**
- Display setup : **Standard, Dot Join on, Persistence off, Single grid**
- Input Coupling : **DC 1M Ω**
- V/div. offset : **Normal**
- Probe atten : **X1**
- Global BWL : **Off**

Section 5 Performance Verification

- Input gain : **5 mV/div.**
- Trigger setup : **Edge**
- Trigger on : **1**
- Coupling 1 : **DC**
- Slope 1 : **Pos**
- Holdoff : **Off**
- Trigger Mode : **Auto**
- Timebase : **20 msec/div.**
- Record up to : **50 K**

11-Jul-94
10:01:47

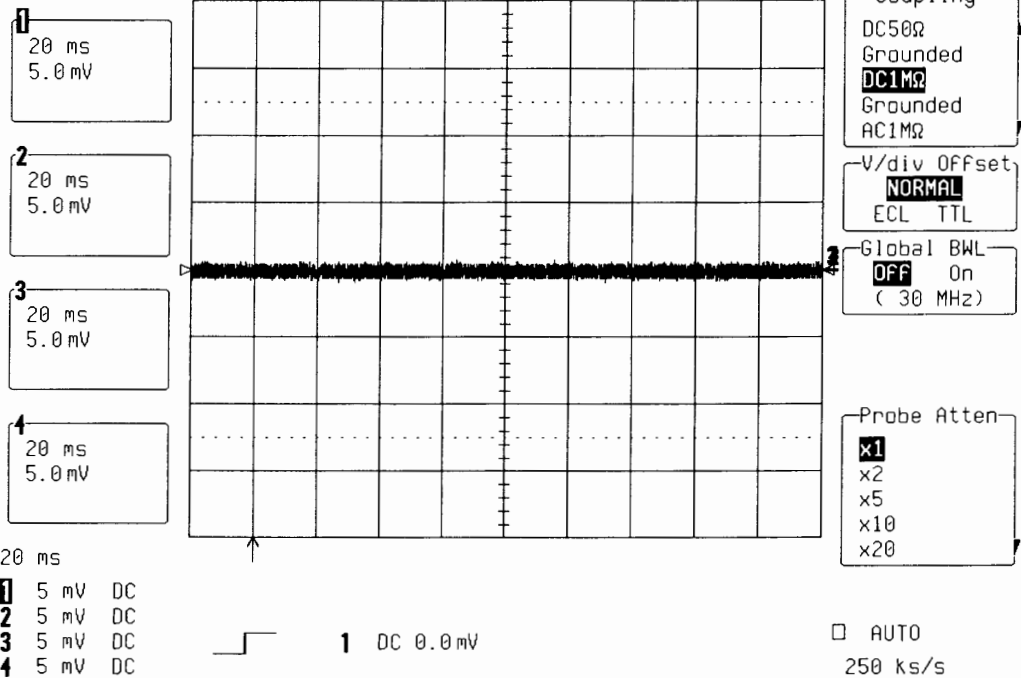

- Press : **Cursors/Measure**
- Measure : **Parameters**
- Mode : **Custom**
- Statistics : **On**

▪ **Change parameters**

- On line 1 : **Measure pkpk of Ch1**
- On line 2 : **Measure pkpk of Ch2**
- On line 3 : **Measure pkpk of Ch3**
- On line 4 : **Measure pkpk of Ch4**

11-Jul-94
10:02:34

1 20 ms
5.0 mV

2 20 ms
5.0 mV

3 20 ms
5.0 mV

4 20 ms
5.0 mV

20 ms
1 5 mV DC
2 5 mV DC
3 5 mV DC
4 5 mV DC

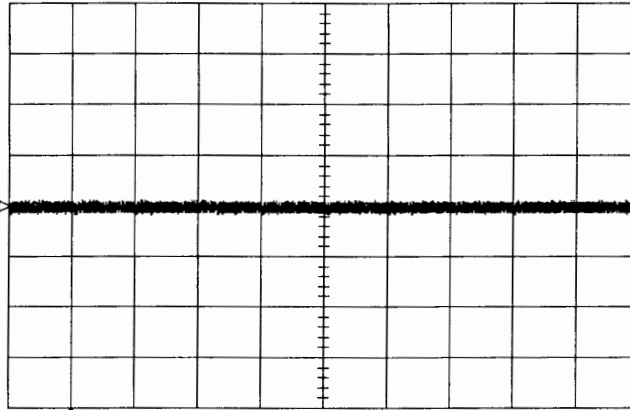

186 sweeps: average low high sigma

	average	low	high	sigma
pkpk (1)	1.53 mV	1.41	1.72	0.10
pkpk (2)	1.62 mV	1.41	1.87	0.10
pkpk (3)	1.52 mV	1.25	1.72	0.11
pkpk (4)	1.48 mV	1.25	1.87	0.11

1 DC 0.0 mV

MEASURE

OFF Cursors
Parameters

mode
Std Voltage
Std Time
Custom
Pass
Fail

statistics
OFF On

CHANGE
PARAMETERS

from
0.00 div
Track OFF On

to
10.00 div

AUTO
250 ks/s

11-Jul-94
10:02:55

1 20 ms
5.0 mV

2 20 ms
5.0 mV

3 20 ms
5.0 mV

4 20 ms
5.0 mV

20 ms
1 5 mV DC
2 5 mV DC
3 5 mV DC
4 5 mV DC

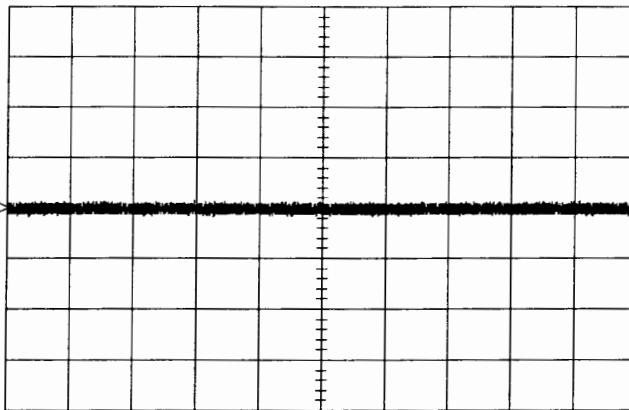

225 sweeps: average low high sigma

	average	low	high	sigma
pkpk (1)	1.53 mV	1.41	1.72	0.11
pkpk (2)	1.62 mV	1.41	1.87	0.10
pkpk (3)	1.53 mV	1.25	1.72	0.10
pkpk (4)	1.48 mV	1.25	1.87	0.11

1 DC 0.0 mV

CHANGE PARAM

On line
1 2 3 4 5

DELETE ALL
PARAMETERS

measure
over-
period
pkpk
points
rise

of
1 2 3 4
A B C D

AUTO
250 ks/s

Section 5 Performance Verification

- Check after at least 100 sweeps that : high pkpk readout is less than $\pm 3.6 \text{ mV}$, corresponding to **9% of full scale**.
- Repeat the test for Timebase : **2 msec/div, .2 msec/div, 20 $\mu\text{sec/div}$, and 10 $\mu\text{sec/div}$.** and check as above.

5.6.1.b AC 1M Ω

- Select Coupling Ch1, Ch2, Ch3, Ch4 : **AC 1M Ω**
- Check after at least 100 sweeps that the high pkpk readout is less than $\pm 3.6 \text{ mV}$, corresponding to **9% of full scale**.
- Repeat the test for Timebase : **2 msec/div, .2 msec/div, 20 $\mu\text{sec/div}$, and 10 $\mu\text{sec/div}$.** and check as above.

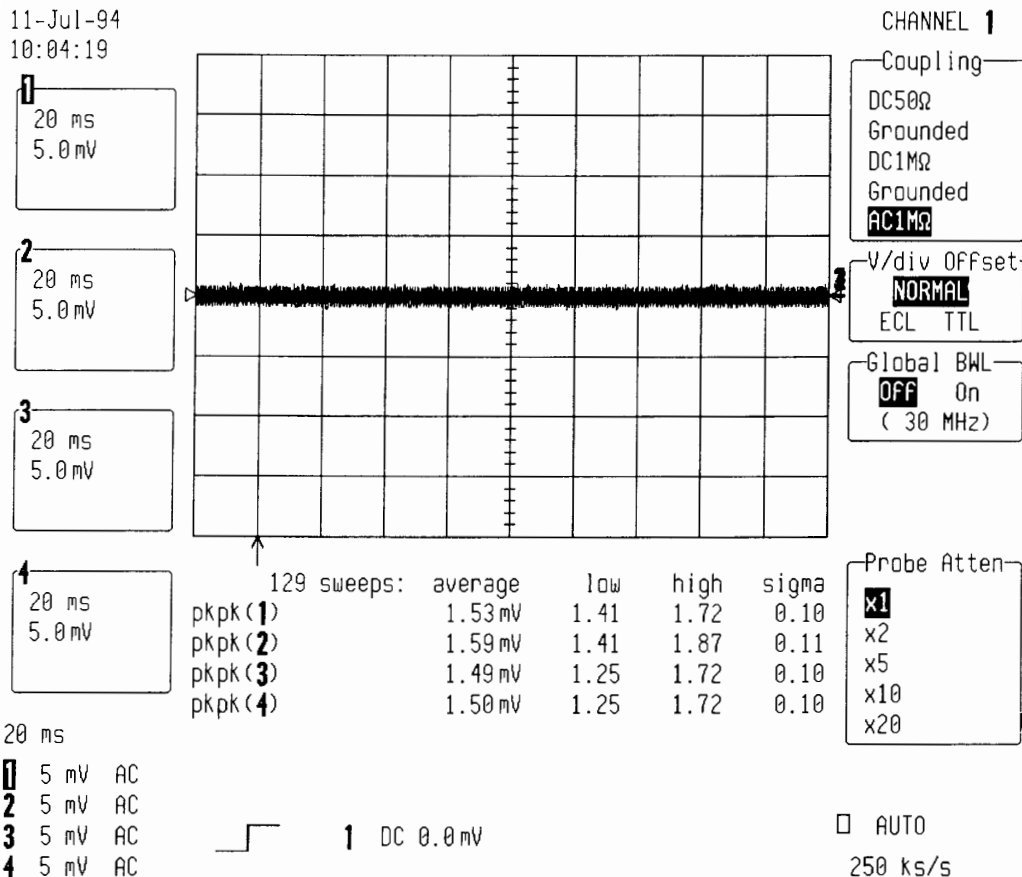

5.6.1.c DC 50Ω

- Select Coupling Ch1, Ch2, Ch3, Ch4 : DC 50Ω
- Check after at least 100 sweeps that the high pkpk readout is less than ± 3.6 mV, corresponding to 9% of full scale.
- Repeat the tests for Timebase : 2 msec/div, .2 msec/div, 20 μsec/div, and 10 μsec/div. and check as above.

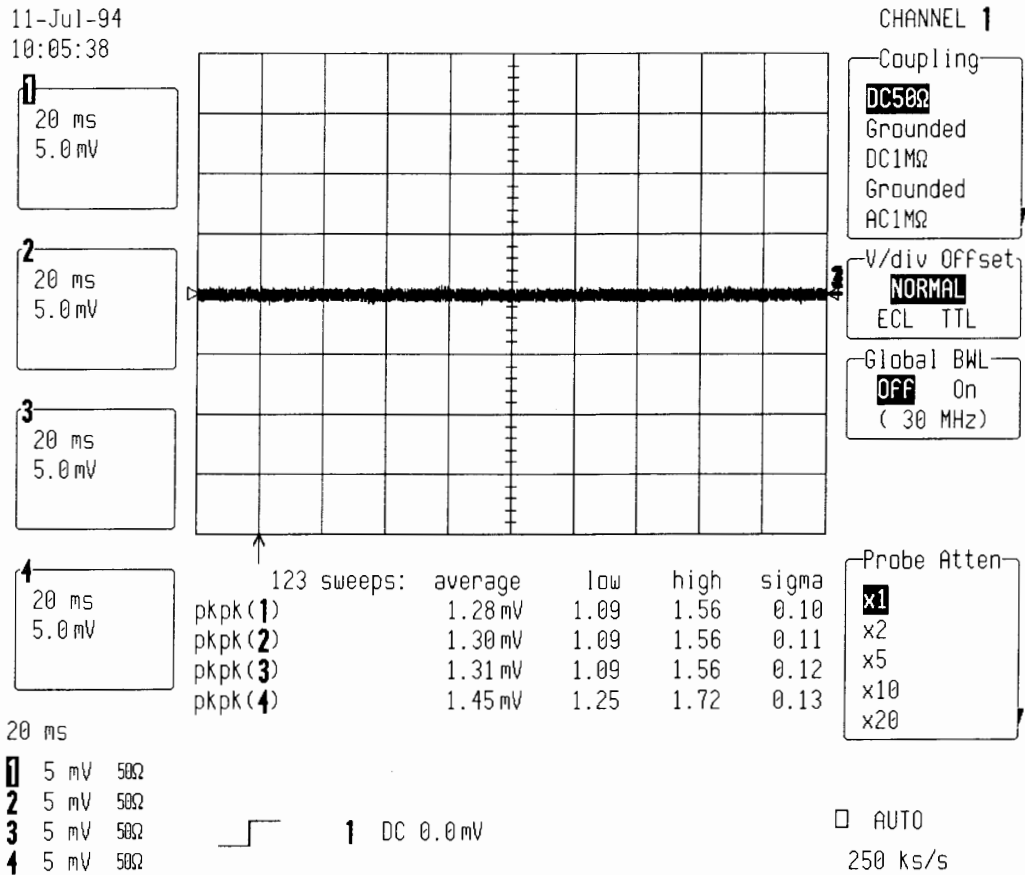

5.6.2 Rms Noise

Specifications

< $\pm 360 \mu\text{V}$ at 5 mV/div.

5.6.2.a DC $1\text{M}\Omega$

Procedure

- With no signal connected to the inputs, set 9314A/M/L DSO settings as follows :
 - Turn on trace : **Ch1, Ch2, Ch3, Ch4**
 - Display setup : **Standard, Dot Join on, Persistence off, Single grid**
 - Input Coupling : **DC $1\text{M}\Omega$**
 - V/div. offset : **Normal**
 - Probe atten : **X1**
 - Global BWL : **Off**
 - Input gain : **5 mV/div.**
 - Trigger setup : **Edge**
 - Trigger on : **1**
 - Coupling 1 : **DC**
 - Slope 1 : **Pos**
 - Holdoff : **Off**
 - Trigger Mode : **Auto**
 - Timebase : **20 msec/div.**
 - Record up : **50 K**

 - Press : **Cursors/Measure**
 - Measure : **Parameters**
 - Mode : **Custom**
 - Statistics : **On**

 - Change parameters
 - On line 1 : **Measure sdev of Ch1**
 - On line 2 : **Measure sdev of Ch2**
 - On line 3 : **Measure sdev of Ch3**
 - On line 4 : **Measure sdev of Ch4**

- Check after at least 100 sweeps that : high sdev readout is less than $\pm 360 \mu\text{V}$, corresponding to **.9% of full scale**.

- Repeat the test for Timebase : **2 msec/div, .2 msec/div, 20 $\mu\text{sec/div}$, and 10 $\mu\text{sec/div}$.** and check as above.

11-Jul-94
10:12:00

CHANGE PARAM

1
20 ms
5.0 mV

2
20 ms
5.0 mV

3
20 ms
5.0 mV

4
20 ms
5.0 mV

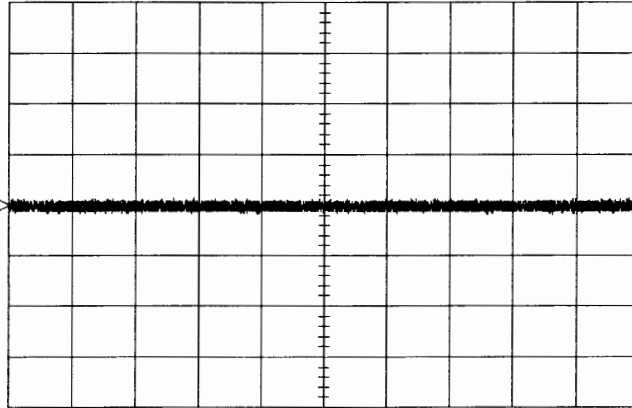

102 sweeps:

	average	low	high	sigma
sdev(1)	180.9 μ V	178.0	183.0	1.1
sdev(2)	175.3 μ V	171.8	177.3	0.8
sdev(3)	172.9 μ V	167.0	195.5	3.3
sdev(4)	159.6 μ V	156.9	178.4	2.2

On line
1 2 3 4 5

DELETE ALL
PARAMETERS

measure
r@level
rms
sdev
top
width

of
1 2 3 4
A B C D

- 20 ms
- 1 5 mV DC
 - 2 5 mV DC
 - 3 5 mV DC
 - 4 5 mV DC

1 DC 0.0 mV

AUTO
250 ks/s

11-Jul-94
10:19:43

CHANNEL 1

1
20 ms
5.0 mV

2
20 ms
5.0 mV

3
20 ms
5.0 mV

4
20 ms
5.0 mV

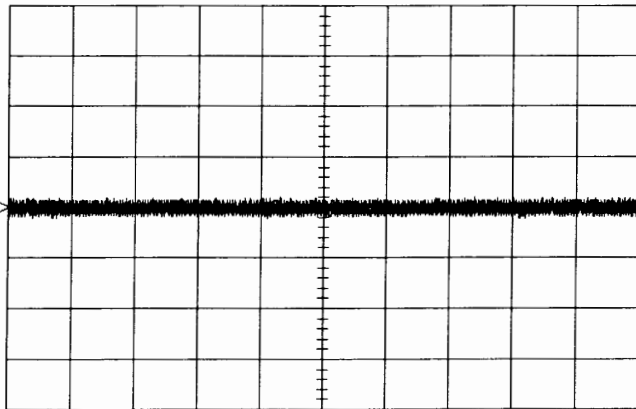

152 sweeps:

	average	low	high	sigma
sdev(1)	189.0 μ V	187.4	190.7	0.6
sdev(2)	205.8 μ V	203.2	209.8	1.2
sdev(3)	184.3 μ V	182.3	186.0	0.7
sdev(4)	162.9 μ V	161.3	164.8	0.6

Coupling
DC50 Ω
Grounded
DC1M Ω
Grounded
AC1M Ω

V/div Offset
NORMAL
ECL TTL

Global BWL
OFF On
(30 MHz)

Probe Atten
x1
x2
x5
x10
x20

- 20 ms
- 1 5 mV AC
 - 2 5 mV AC
 - 3 5 mV AC
 - 4 5 mV AC

1 DC 0.0 mV

AUTO
250 ks/s

5.6.2.b AC 1MΩ

- Select Coupling Ch1, Ch2, Ch3, Ch4 : **AC 1MΩ**
- Check after at least 100 sweeps that the high pkpk readout is less than $\pm 360 \mu\text{V}$, corresponding to **.9% of full scale**.
- Repeat the test for Timebase : **2 msec/div, .2 msec/div, 20 μsec/div, and 10 μsec/div.** and check as above.

5.6.2.c DC 50Ω

- Select Coupling Ch1, Ch2, Ch3, Ch4 : **DC 50Ω**
- Check after at least 100 sweeps that the high pkpk readout is less than $\pm 360 \mu\text{V}$, corresponding to **.9% of full scale**.
- Repeat the tests for Timebase : **2 msec/div, .2 msec/div, 20 μsec/div, and 10 μsec/div.** and check as above.

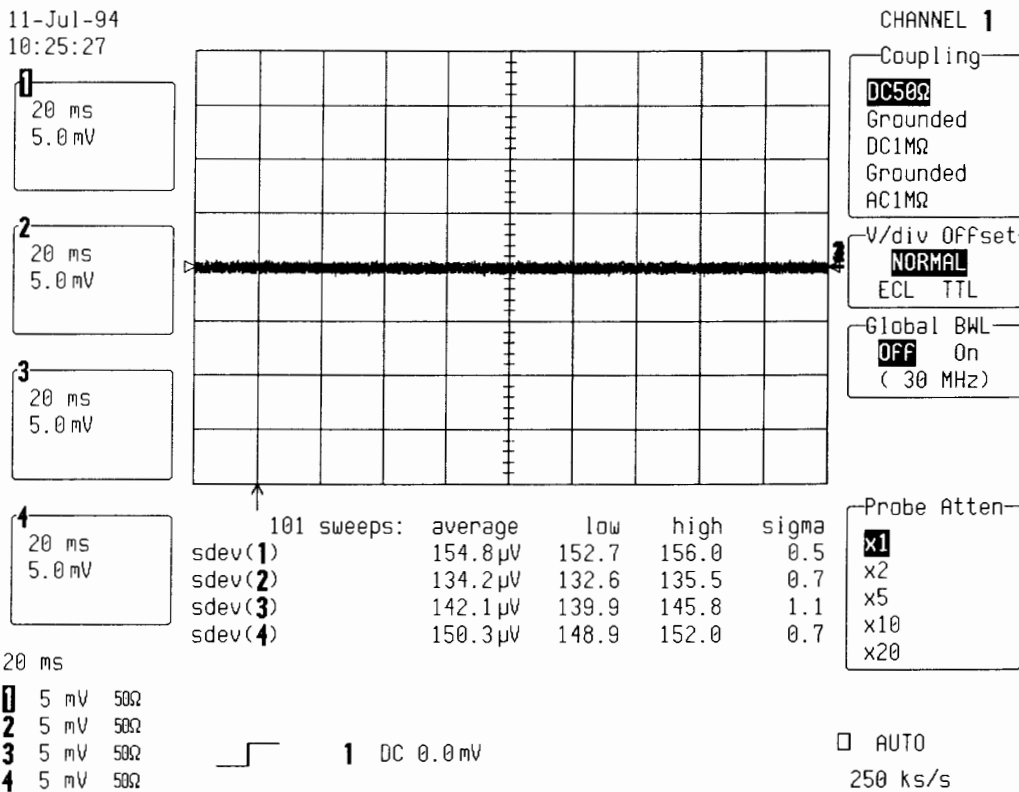

5.6.3 Inputs Grounded

With no cable plugged into scope, set the DSO as follows :

- Turn on trace : **Channel 1, Channel 2, Channel 3, Channel 4**
- Input Coupling : **DC 50 Ω**
- Input gain : **10 mV/div.**
- Offset : **Zero**
- Trigger on : **Channel 1, DC**
- Trigger mode : **Auto**
- Timebase : **50 μ sec/div.**
- Record up : **50 K**
- Turn off trace : **Channel 1, Channel 2, Channel 3, Channel 4**

- Turn on trace : **A, B, C, D**
- Select Math Setup
- For Math : **Use at most 5000 points**
- Redefine A, B, C, D : **Channel 1, Channel 2, Channel 3, Channel 4**
- Use Math ? : **Yes**
- Math Type : **Average**
- Avg Type : **Summed**
- For : **1000 sweeps**

- Cursors/Measure : **Parameters**
- Mode : **Custom**
- Statistics : **off**
- Change parameters
- On line 1 : **Measure mean of A**
- On line 2 : **Measure mean of B**
- On line 3 : **Measure mean of C**
- On line 3 : **Measure mean of D**

- Check after at least 100 sweeps that the **mean** value of **A, B, C, D** is less than **± 1.6 mV**, corresponding to $\pm 2\%$ of full scale.
- Switch Channel 1, Channel 2, Channel 3 and Channel 4 between coupling **DC 50 Ω** and **Grounded**.
- Check after at least 100 sweeps that the **mean** value of **A, B, C, D** is less than **± 1.6 mV**, corresponding to $\pm 2\%$ of full scale.
- Set coupling all Channel : **DC 1M Ω**
- Check after at least 100 sweeps that the **mean** value of **A, B, C, D** is less than **± 1.6 mV**, corresponding to $\pm 2\%$ of full scale.
- Switch all Channel between coupling **DC 1M Ω** and **Grounded**.
- Check after at least 100 sweeps that the **mean** value of **A, B, C, D** is less than **± 1.6 mV**, corresponding to $\pm 2\%$ of full scale.

Section 5 Performance Verification

11-Jul-94
10:28:12

A: Average(1)
50 μ s
10.0 mV
144 swps

B: Average(2)
50 μ s
10.0 mV
105 swps

C: Average(3)
50 μ s
10.0 mV
78 swps

D: Average(4)
50 μ s
10.0 mV
61 swps

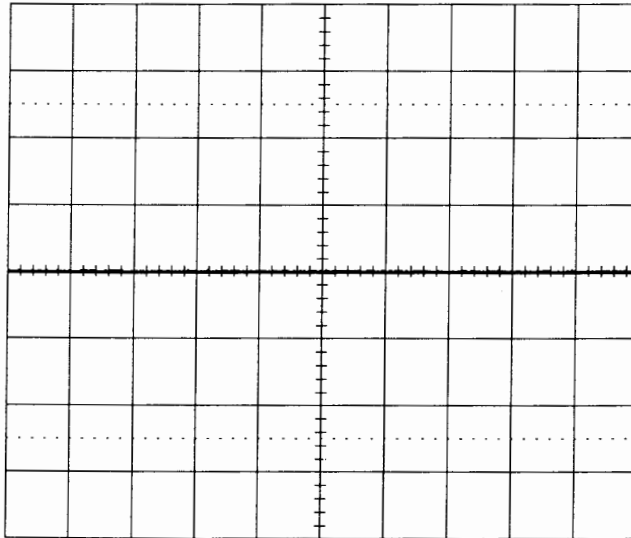

50 μ s

- 1 10 mV 50 Ω
- 2 10 mV 50 Ω
- 3 10 mV 50 Ω
- 4 10 mV 50 Ω

1 DC 0.0 mV

ZOOM + MATH

REDEFINE **A**
A=Average(1)

REDEFINE **B**
B=Average(2)

REDEFINE **C**
C=Average(3)

REDEFINE **D**
D=Average(4)

Multi-Zoom
OFF On

For Math
use at most
5000 points

AUTO
100 Ms/s

11-Jul-94
10:28:35

A: Average(1)
50 μ s
10.0 mV
184 swps

B: Average(2)
50 μ s
10.0 mV
145 swps

C: Average(3)
50 μ s
10.0 mV
118 swps

D: Average(4)
50 μ s
10.0 mV
101 swps

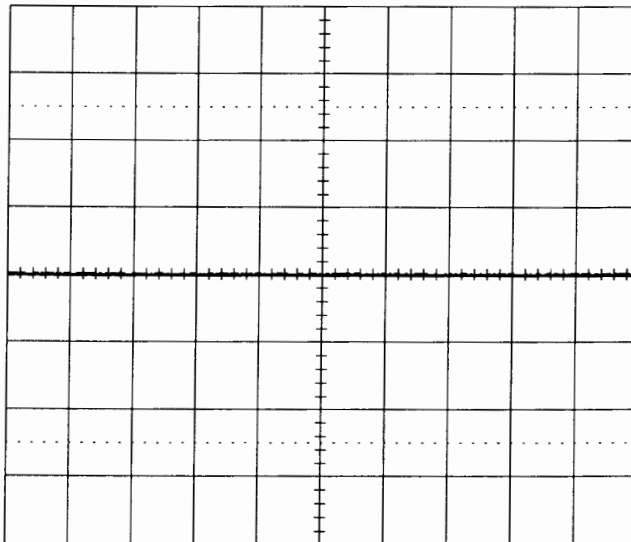

50 μ s

- 1 10 mV 50 Ω
- 2 10 mV 50 Ω
- 3 10 mV 50 Ω
- 4 10 mV 50 Ω

A: Average(1) 50000 -> 5000 points

SETUP OF **A**

use Math?
No **Yes**

Math Type
Arithmetic
Average
Functions

Avg Type
Summed

For
1000
(sweeps)

of
1 2 3 4 B C D
M1 M2 M3 M4

AUTO
100 Ms/s

11-Jul-94
10:31:10

A: Average (1)
50 μ s
10.0 mV

349 swps

B: Average (2)
50 μ s
10.0 mV

310 swps

C: Average (3)
50 μ s
10.0 mV

283 swps

D: Average (4)
50 μ s
10.0 mV

266 swps

- 50 μ s
- 1** 10 mV 50 Ω
- 2** 10 mV 50 Ω
- 3** 10 mV 50 Ω
- 4** 10 mV 50 Ω

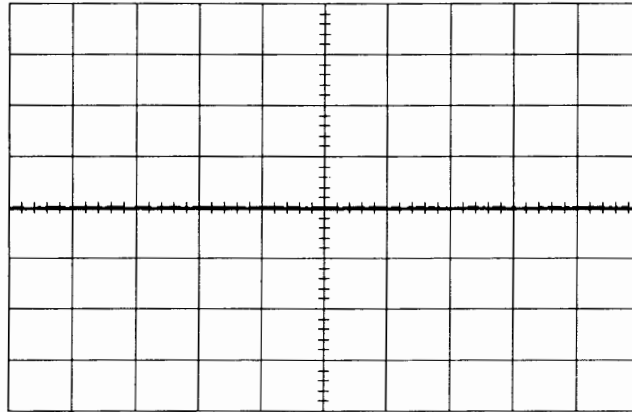

mean(A) -103.76 μ V
mean(B) -195.31 μ V
mean(C) -59.81 μ V
mean(D) \approx 84.23 μ V

1 DC 0.0 mV

MEASURE

Off Cursors
Parameters

mode
Std Voltage
Std Time
Custom
Pass
Fail

statistics
OFF On

CHANGE
PARAMETERS

From
0.00 div
Track **OFF** On

to
10.00 div

AUTO
100 Ms/s

11-Jul-94
10:32:00

A: Average (1)
50 μ s
10.0 mV

398 swps

B: Average (2)
50 μ s
10.0 mV

359 swps

C: Average (3)
50 μ s
10.0 mV

332 swps

D: Average (4)
50 μ s
10.0 mV

315 swps

- 50 μ s
- 1** 10 mV 50 Ω
- 2** 10 mV 50 Ω
- 3** 10 mV 50 Ω
- 4** 10 mV 50 Ω

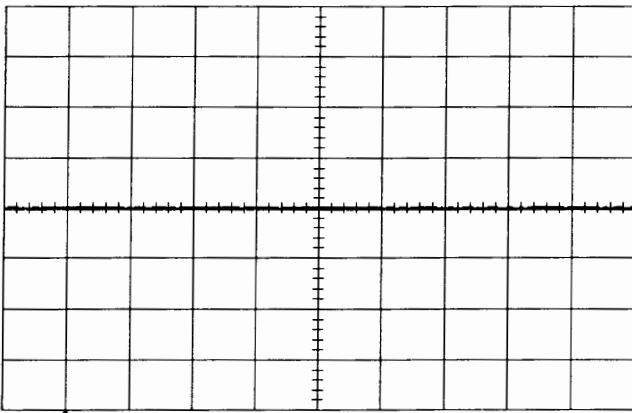

mean(A) -104.98 μ V
mean(B) -194.09 μ V
mean(C) -52.49 μ V
mean(D) \approx 85.45 μ V

1 DC 0.0 mV

CHANGE PARAM

On line
1 2 3 4 5

DELETE ALL
PARAMETERS

measure
last
maximum
mean
median
minimum

of
1 2 3 4
A **B** **C** **D**

AUTO
100 Ms/s

Section 5 Performance Verification

11-Jul-94
10:44:47

- A:** Average (1)
50 μ s
10.0 mV
701 swps
- B:** Average (2)
50 μ s
10.0 mV
699 swps
- C:** Average (3)
50 μ s
10.0 mV
697 swps
- D:** Average (4)
50 μ s
10.0 mV
695 swps

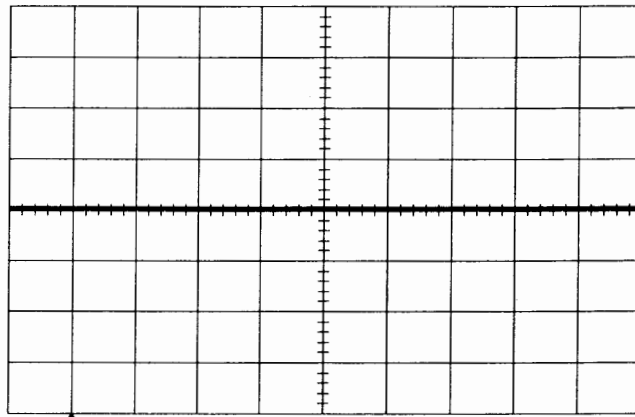

mean(A)	\neq	275.88 μ V
mean(B)	\neq	-2.44 μ V
mean(C)		211.18 μ V
mean(D)		516.36 μ V

- 50 μ s
- 1** 10 mV $\frac{1}{2}$
 - 2** 10 mV $\frac{1}{2}$
 - 3** 10 mV $\frac{1}{2}$
 - 4** 10 mV $\frac{1}{2}$

1 DC 0.0 mV

CHANNEL 1

Coupling
DC50 Ω
Grounded
DC1M Ω
Grounded
AC1M Ω

V/div Offset
NORMAL
ECL TTL

Global BWL
OFF On
(30 MHz)

Probe Atten
x1
x2
x5
x10
x20

AUTO
100 Ms/s

11-Jul-94
10:35:06

- A:** Average (1)
50 μ s
10.0 mV
109 swps
- B:** Average (2)
50 μ s
10.0 mV
107 swps
- C:** Average (3)
50 μ s
10.0 mV
105 swps
- D:** Average (4)
50 μ s
10.0 mV
103 swps

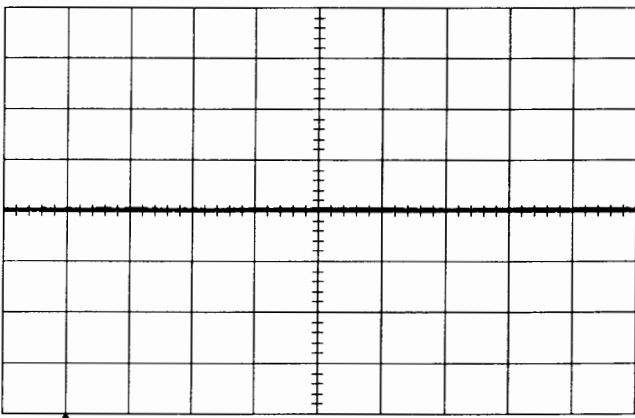

mean(A)	\neq	271.00 μ V
mean(B)	\neq	-9.77 μ V
mean(C)		173.34 μ V
mean(D)		488.28 μ V

- 50 μ s
- 1** 10 mV $\frac{1}{2}$
 - 2** 10 mV $\frac{1}{2}$
 - 3** 10 mV $\frac{1}{2}$
 - 4** 10 mV $\frac{1}{2}$

1 DC 0.0 mV

CHANNEL 1

Coupling
DC50 Ω
Grounded
DC1M Ω
Grounded
AC1M Ω

V/div Offset
NORMAL
ECL TTL

Global BWL
OFF On
(30 MHz)

Probe Atten
x1
x2
x5
x10
x20

AUTO
100 Ms/s

5.7 DC Linearity

Specification

$\leq \pm 2\%$ of full scale at 0 mV offset

5.7.1 Description

This test measures the DC Accuracy within the gain range specified.
The parameters Std voltage are used to measure the amplitude of the DC input signal.

In the absence of the computer automated calibration system based on LeCroy Calibration Software (LeCalsoft) for the 9314A/M/L model oscilloscope, the manual performance test procedure can be followed to establish a traceable calibration, provided that the measurement instruments used are themselves traceable.
For such calibration, follow the manual linearity test procedure using a calibrated and certified high precision (better than 0.1 %) voltage source, for example TEK PS5004 or equivalent, or use a certified DMM to measure the applied voltage.

5.7.1.a DC 50 Ω

Procedure

- Turn on trace : **Ch1**
- Display setup : **Standard, Persistence off, Dot join on, Single grid**
- Input Coupling : **DC 50 Ω**
- V/div. offset : **Normal**
- Global BWL : **Off**
- Probe atten : **X1**
- Input offset : **0.0 mV**
- Input gain : **from 2mV/div to 5 V/div. (see table 5-2 and 5-3)**
- Trigger setup : **Edge**
- Trigger on : **1**
- Coupling 1 : **DC**
- Slope 1 : **Pos**
- Mode : **Auto**
- Holdoff : **Off**
- Timebase : **2 msec/div.**
- Record up : **50 K**

- Turn on trace : **A**
- Select Math Setup
- For Math : **Use at most 5000 points**
- Redefine A
- Use Math ? : **Yes**
- Math Type : **Average**
- Avg Type : **Summed**
- For : **1000 sweeps**
- Of : **Channel 1**

- Turn off trace : **Channel 1**
- Cursors/Measure : **Parameters**
- Mode : **Std Voltage**
- Statistics : **off**
- on displayed trace : **A**

5.7.1.a.1 Positive DC Linearity

- For the ranges **2 mV/div. to 1 V/div.**, from the high precision voltage source, apply to Channel 1 : **+ 3 major screen divisions**.
- For the low sensitivities : **2 mV, 5 mV, 10 mV, 20 mV and 50 mV/div.**, use a **50 Ohm 20 dB** attenuator.
- For the range **2V/div. and 5V/div.**, the maximum input voltage is **+ 5 V**.

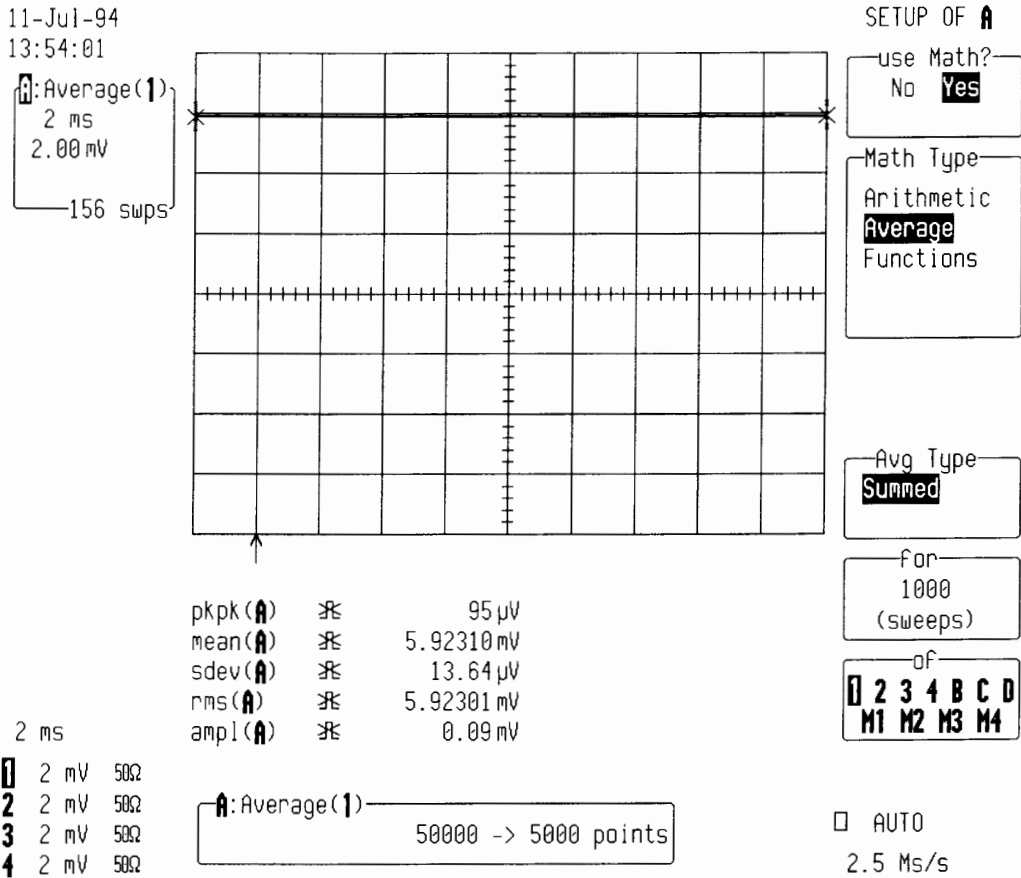

Range	Attenuator	Conditions of Test			Average Mean Parameter Reading		
		PS Output	9314A Input	9314A Full scale	Min Value -X % of FS	Max Value +X% of FS	X%
2 mV	Yes	+ 60 mV	+ 6 mV	16 mV	+ 5.2 mV	+ 6.8 mV	5%
5 mV	Yes	+ 150 mV	+ 15 mV	40 mV	+ 13.8 mV	+ 16.2 mV	3%
10 mV	Yes	+ 300 mV	+ 30 mV	80 mV	+ 28.4 mV	+ 31.6 mV	2%
20 mV	Yes	+ 600 mV	+ 60 mV	160 mV	+ 56.8 mV	+ 63.2 mV	2%
50 mV	Yes	+ 1.5 V	+150 mV	400 mV	+ 142 mV	+ 158 mV	2%
.1 V	No	+ 300 mV	+ 300 mV	800 mV	+ 284 mV	+ 316 mV	2%
.2 V	No	+ 600 mV	+ 600 mV	1.6 v	+ 568 mV	+ 632 mV	2%
.5 V	No	+ 1.5 V	+ 1.5 V	4 V	+ 1.42 V	+ 1.58 V	2%
1 V	No	+ 3 V	+ 3 V	8 V	+ 2.84 V	+ 3.16 V	2%
2 V	No	Max +5 V	Max +5 V	16 V	+ 4.68 V	+ 5.32 V	2%
5 V	No	Max +5 V	Max +5 V	40 V	+ 4.20 V	+ 5.80 V	2%

Table 5-2 : Positive DC Linearity Readout Accuracy

- For each point, read off the **Mean** parameter voltage, and compare it to the digital readout of the voltage reference
- The **Mean** parameter reading should be within the limits shown in table 5-2.

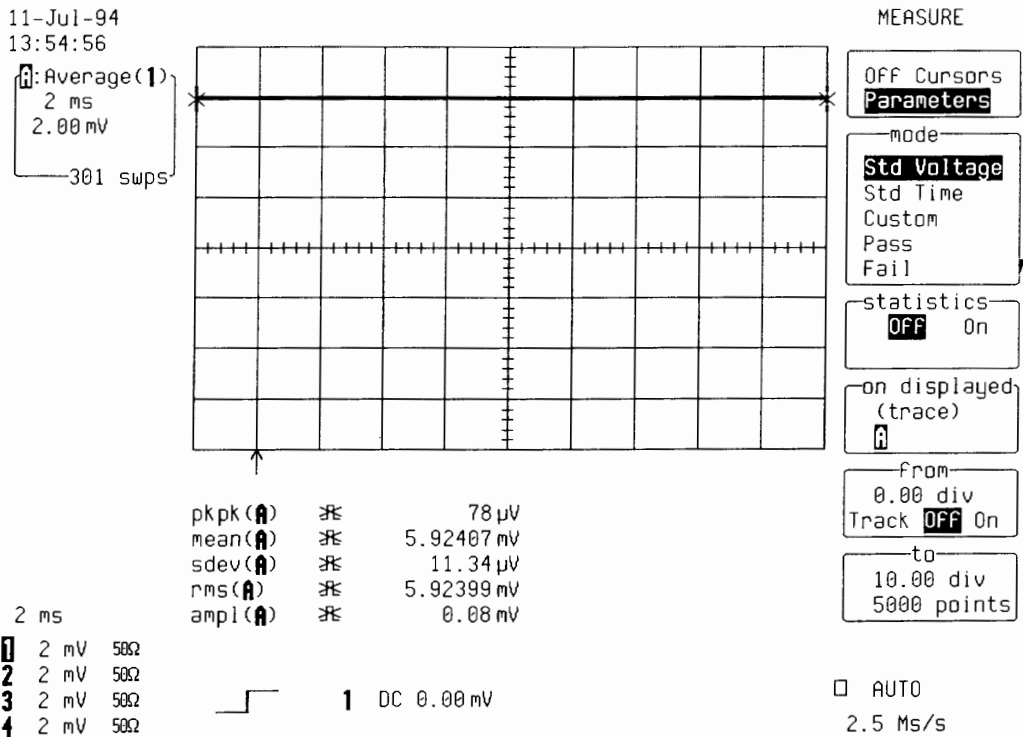

11-Jul-94
13:59:20

Average(1)
2 ms
5.0 V
22 swps

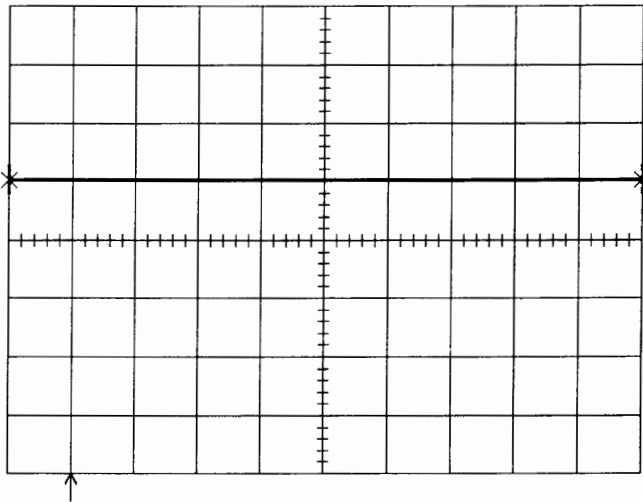

CHANNEL 1
Coupling
DC50Ω
Grounded
DC1MΩ
Grounded
AC1MΩ
V/div Offset
NORMAL
ECL TTL
Global BWL
OFF On
(30 MHz)

pkpk(A) 71 mV
mean(A) 5.17822 V
sdev(A) 12.17 mV
rms(A) 5.17805 V
ampl(A) 0.00 V

Probe Atten
x1
x2
x5
x10
x20

- 2 ms
- 1 5 V 50Ω
 - 2 5 V 50Ω
 - 3 5 V 50Ω
 - 4 5 V 50Ω

 1 DC 0.0 V

AUTO
2.5 Ms/s

5.7.1.a.2 Negative DC Linearity

- For the ranges **2 mV/div. to 1 V/div.**, from the high precision voltage source, apply to Channel 1 : - **3 major screen divisions**.
- For the low sensitivities : **2 mV, 5 mV, 10 mV, 20 mV and 50 mV/div.**, use a **50Ω 20 dB** attenuator.
- For the range **2V/div. and 5V/div.**, the minimum input voltage is - **5 V**.
- For each point, read off the **Mean** parameter voltage, and compare it to the digital readout of the voltage reference.
- The **mean** parameter reading should be within the limits shown in table 5-3.

Range	Attenuator	Conditions of Test			Average Mean Parameter Reading		
		PS Output	9314A Input	9314A Full scale	Min Value -X % of FS	Max Value +X% of FS	X%
2 mV	Yes	- 60 mV	- 6 mV	16 mV	- 5.2 mV	- 6.8 mV	5%
5 mV	Yes	- 150 mV	- 15 mV	40 mV	- 13.8 mV	- 16.2 mV	3%
10 mV	Yes	- 300 mV	- 30 mV	80 mV	- 28.4 mV	- 31.6 mV	2%
20 mV	Yes	- 600 mV	- 60 mV	160 mV	- 56.8 mV	- 63.2 mV	2%
50 mV	Yes	- 1.5 V	-150 mV	400 mV	- 142 mV	- 158 mV	2%
.1 V	No	- 300 mV	- 300 mV	800 mV	- 284 mV	- 316 mV	2%
.2 V	No	- 600 mV	- 600 mV	1.6 v	- 568 mV	- 632 mV	2%
.5 V	No	- 1.5 V	- 1.5 V	4 V	- 1.42 V	- 1.58 V	2%
1 V	No	- 3 V	- 3 V	8 V	- 2.84 V	- 3.16 V	2%
2 V	No	Max -5 V	Max -5 V	16 V	- 4.68 V	- 5.32 V	2%
5 V	No	Max -5 V	Max -5 V	40 V	- 4.20 V	- 5.80 V	2%

Table 5-3 : Negative DC Linearity Readout Accuracy

11-Jul-94
14:03:24

Average(1)
2 ms
200 mV
123 swps

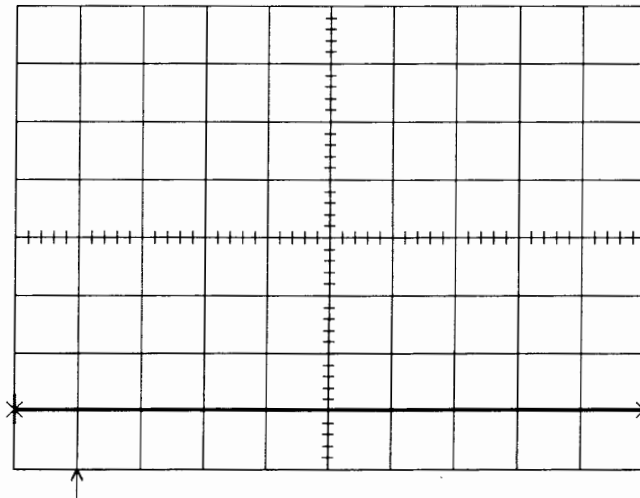

pkpk(A) 3.0mV
mean(A) -593.115mV
sdev(A) 451µV
rms(A) 593.124mV
ampl(A) 3mV

- 1 .2 V 50Ω
- 2 .2 V 50Ω
- 3 .2 V 50Ω
- 4 .2 V 50Ω

1 DC 0.000 V

MEASURE

Parameters
mode
Std Voltage
Std Time
Custom
Pass
Fail
statistics
OFF On
on displayed (trace)
A
from
0.00 div
Track OFF On
to
10.00 div
5000 points

AUTO
2.5 Ms/s

11-Jul-94
14:05:08

Average(1)
2 ms
5.0 V
17 swps

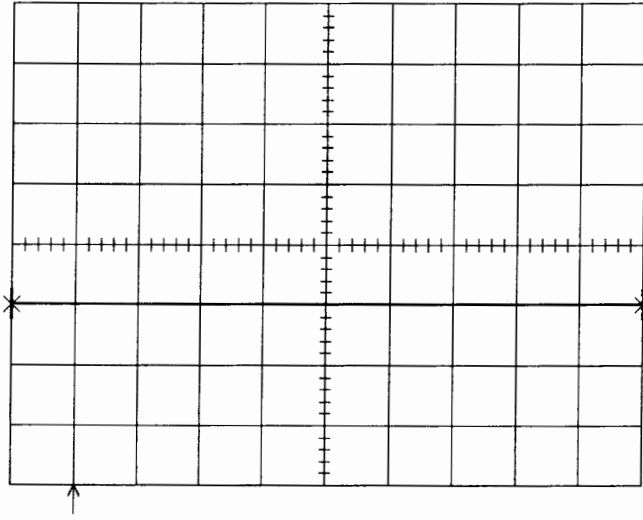

pkpk(A) 101 mV
mean(A) -4.97864 V
sdev(A) 14.20 mV
rms(A) 4.97896 V
ampl(A) 0.00 V

2 ms

- 1 5 V 50Ω
- 2 5 V 50Ω
- 3 5 V 50Ω
- 4 5 V 50Ω



1 DC 0.0 V

MEASURE

Off Cursors
Parameters

mode
Std Voltage
Std Time
Custom
Pass
Fail

statistics
OFF On

on displayed (trace)
A

from
0.00 div
Track **OFF** On

to
10.00 div
5000 points

AUTO
2.5 Ms/s

5.7.1.b DC 1MΩ

Set the DSO as follows :

- Input Coupling : **DC 1MΩ**
- Input offset : **0.0 mV**
- Input gain : **from 2mV/div. to 5 V/div.**

- For the ranges **2 mV/div. to 5 V/div.**, from the high precision voltage source, apply to Channel 1 the following 2 voltages values, one after another : **+ 3 major** screen divisions, **- 3 major** screen divisions.

- For the low sensitivities : **2, 5, 10, 20** and **50 mV/div.**, use a **1 MΩ 20 dB** attenuator (1/10), see table 5-4.

Range	Attenuator	Conditions of Test			Average Mean Parameter Reading		
		PS Output	9314A Input	9314A Full scale	Min Value ±X% of FS	Max Value ±X% of FS	± X%
Volt/div Control	20 dB						
2 mV	Yes	± 60 mV	± 6 mV	16 mV	± 5.2 mV	± 6.8 mV	5%
5 mV	Yes	± 150 mV	± 15 mV	40 mV	± 13.8 mV	± 16.2 mV	3%
10 mV	Yes	± 300 mV	± 30 mV	80 mV	± 28.4 mV	± 31.6 mV	2%
20 mV	Yes	± 600 mV	± 60 mV	160 mV	± 56.8 mV	± 63.2 mV	2%
50 mV	Yes	± 1.5 V	±150 mV	400 mV	± 142 mV	± 158 mV	2%
.1 V	No	± 300 mV	± 300 mV	800 mV	± 284 mV	± 316 mV	2%
.2 V	No	± 600 mV	± 600 mV	1.6 v	± 568 mV	± 632 mV	2%
.5 V	No	± 1.5 V	± 1.5 V	4 V	± 1.42 V	± 1.58 V	2%
1 V	No	± 3 V	± 3 V	8 V	± 2.84 V	± 3.16 V	2%
2 V	No	± 6 V	± 6 V	16 V	± 5.68 V	± 6.32 V	2%
5 V	No	± 15 V	± 15 V	40 V	± 14.2 V	± 15.8 V	2%

Table 5-4 : 1M Ω DC Linearity Readout Accuracy

- For each point, read off the **Mean** parameter voltage, and compare it to the digital readout of the voltage reference.
- The **mean** parameter reading should be within the limits shown in table 5-4.
- Repeat steps 5.7.1.a and 5.7.1.b for Channel 2, Channel 3, and Channel 4 substituting channel control and input connector.

Section 5 Performance Verification

11-Jul-94
14:07:03

Average(1)
2 ms
1.00 V
75 swps

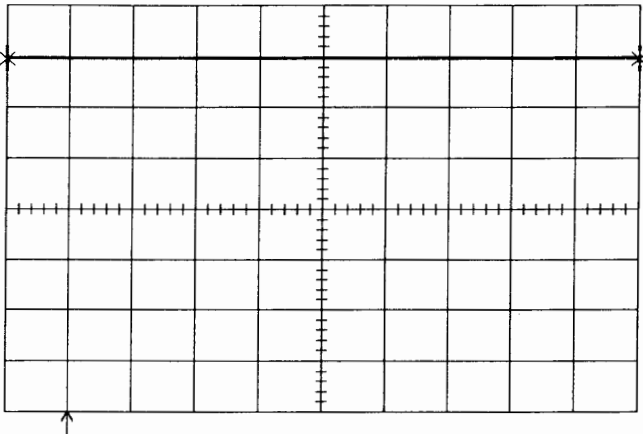

pkpk(A) 12.9 mV
mean(A) 2.97803 V
sdev(A) 1.756 mV
rms(A) 2.97799 V
ampl(A) -3 mV

- 2 ms
- 1 1 V DC
 - 2 1 V DC
 - 3 1 V DC
 - 4 1 V DC

1 DC 0.00 V

CHANNEL 1

Coupling
DC50Ω
Grounded
DC1MΩ
Grounded
AC1MΩ

V/div Offset
NORMAL
ECL TTL

Global BWL
OFF On
(30 MHz)

Probe Atten

x1
x2
x5
x10
x20

AUTO
2.5 Ms/s

8-Aug-94
10:05:29

Average(1)
2 ms
5.0 V
195 swps

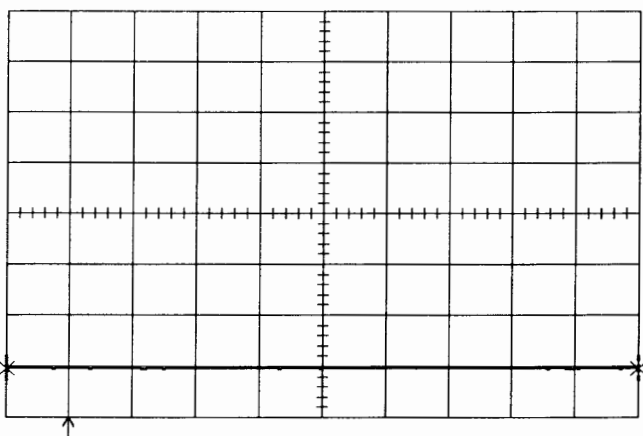

pkpk(A) 68 mV
mean(A) -15.1843 V
sdev(A) 8.72 mV
rms(A) 15.1846 V
ampl(A) 0.07 V

- 2 ms
- 1 5 V DC
 - 2 5 V DC
 - 3 5 V DC
 - 4 5 V DC

1 DC 0.0 V

CHANNEL 1

Coupling
DC50Ω
Grounded
DC1MΩ
Grounded
AC1MΩ

V/div Offset
NORMAL
ECL TTL

Global BWL
OFF On
(30 MHz)

Probe Atten

x1
x2
x5
x10
x20

AUTO
2.5 Ms/s

5.8 Offset

5.8.1 Description

The maximum allowed offsets depend on the sensitivity as shown in table 5-5 and 5-6, and is tested at DC 1 M Ω , over the full 2 mV to 5 V range.

Specifications

- $\pm 120\text{mV}$: for the ranges 2mV/div., 5 mV/div.
- $\pm 1.2\text{ V}$: for 10 mV/div., 20 mV/div., 50 mV/div., 100 mV/div.
- $\pm 24\text{ V}$: for 200 mV/div., 500 mV/div., 1 V/div., 2 V/div., 5 V/div.

5.8.1.a Negative Offset Control Procedure

Set the DSO as follows :

- Turn on trace : **Channel 1**
- Display setup : **Standard, Persistence off, Dot join on, Single grid**
- Input Coupling : **DC 1M Ω**
- V/div. offset : **Normal**
- Global BWL : **Off**
- Probe atten : **X1**
- Input gain : **5 mV**
- Trigger setup : **Edge**
- Trigger on : **1**
- Coupling 1 : **DC**
- Slope 1 : **Pos**
- Mode : **Auto**
- Holdoff : **Off**
- Timebase : **2 msec/div.**
- Record up : **50 K**

- Turn on trace : **A**
- Select Math Setup
- For Math : **Use at most 5000 points**
- Redefine A
- Use Math ? : **Yes**
- Math Type : **Average**
- Avg Type : **Summed**
- For : **1000 sweeps**
- Of : **Channel 1**

- Turn off trace : **Channel 1**
- Cursors/Measure : **Parameters**
- Mode : **Std Voltage**
- Statistics : **off**
- On displayed trace : **A**

Section 5 Performance Verification

- From the high precision voltage source PS5004, apply to Channel 1 + 120 mV .
- Using the offset control, move Channel 1 trace through the entire range until the maximum offset value is reached : - 120 mV.

- Verify that the displayed trace A : Average (1) is in the screen, near to the center horizontal graticule line.

- Press clear sweeps.
- Check after at least 100 sweeps that the mean (A) parameter readout is : + 120 mV ± 3 %.

Range	Conditions of Test		Offset Control	Mean Parameter Reading		
Volts/div Control	PS Output	9314A Input	9314A Offset	Minimum value, -X %	Maximum Value, +X %	
5 mV	+ 120 mV	+ 120 mV	- 120 mV	+ 116.4 mV	+ 123.6 mV	3%
50 mV	+ 1.2 V	+ 1.2 V	- 1.2 V	+ 1.164 V	+ 1.236 V	3%
5 V	+ 20 V	+ 20 V	- 24 V	+ 18.6 V	+ 21.4V	7%

Table 5-5 : Negative offset control

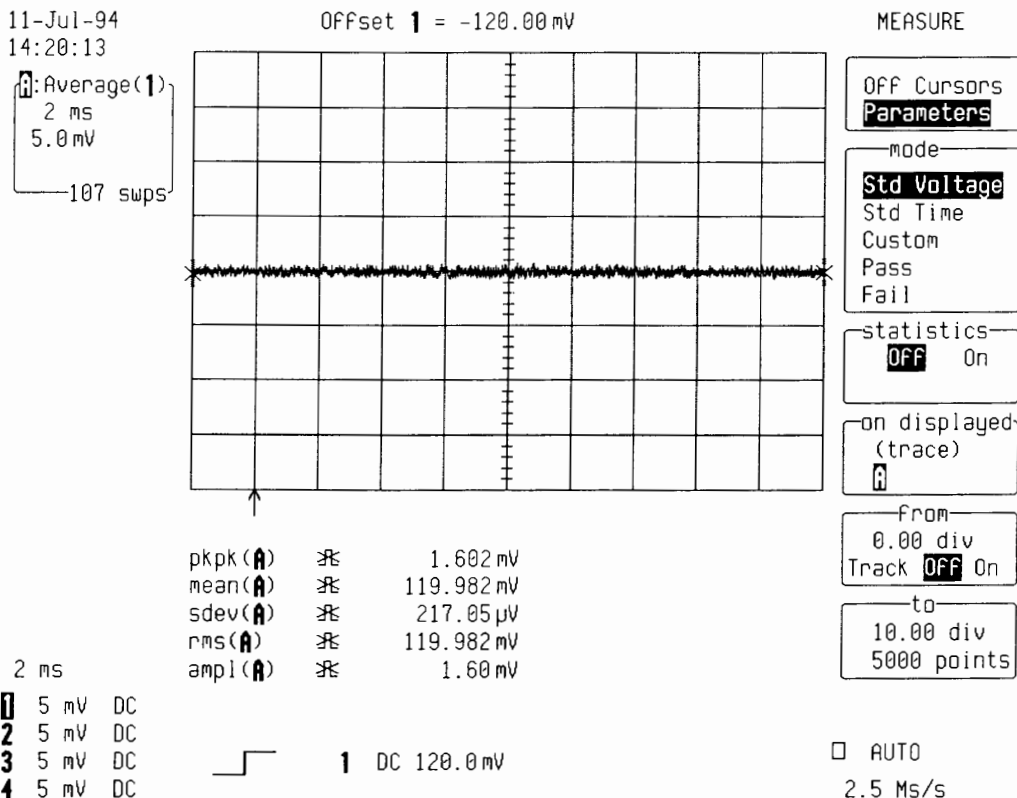

- Set input gain to **50 mV/div.**, from the high precision voltage source, apply to Channel 1 the following voltage value : **+ 1.2 V**.
- Using the offset control, move the Ch1 trace through the entire range until the following offset value is reached : **- 1.2 V**.
- Verify that the displayed trace A : Average (1) is in the screen (near to the center horizontal graticule line).
- Press clear sweeps
- Check after at least 100 sweeps that the mean (A) parameter readout is : **+ 1.2 V ± 3 %** (see table 5-5).

11-Jul-94

14:23:15

Offset 1 = -1.2000 V

MEASURE

Average(1)
2 ms
50 mV
105 swps

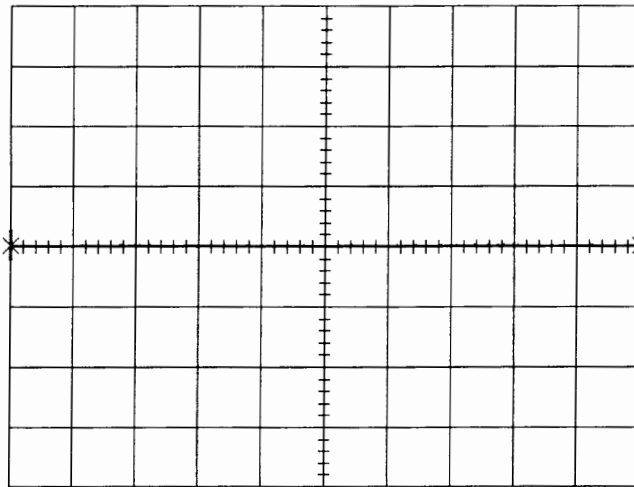

OFF Cursors
Parameters

mode
Std Voltage
Std Time
Custom
Pass
Fail

statistics
OFF On

on displayed
(trace)
A

from
0.00 div
Track OFF On

to
10.00 div
5000 points

pkpk(A)	⊗	1.72 mV
mean(A)	⊗	1.20118 V
sdev(A)	⊗	220.7 μV
rms(A)	⊗	1.20118 V
ampl(A)	⊗	1.7 mV

2 ms

- 1 50 mV DC
- 2 50 mV DC
- 3 50 mV DC
- 4 50 mV DC



1 DC 0.950 V

AUTO
2.5 Ms/s

- Set input gain to **5 V/div.**, from the high precision voltage source, apply to Channel 1 : **+ 20 V** (maximum from PS5004).
- Using the offset control, move the Ch1 trace through the entire range until the maximum offset value is reached : **- 24 V**.
- Verify that the displayed trace A : Average (1) is in the screen
- Press clear sweeps
- Check after at least 100 sweeps that the mean (A) parameter readout is : **+ 20 V ± 7 %** (see table 5-5).
- Repeat step 5.8.1.a for Channel 2, Channel 3 and Channel 4 substituting channel control and input connector.

5.8.1.b Positive Offset Control Procedure

Set the DSO as in 5.8.1.a:

- Channel 1 input gain : **5 mV**
- From the high precision voltage source PS5004, apply to Channel 1 : **- 120 mV** .
- Using the offset control, move Channel 1 trace through the entire range until the maximum offset value is reached : **+ 120 mV**.
- Verify that the displayed trace A : Average (1) is in the screen, near to the center horizontal graticule line.
- Press clear sweeps.
- Check after at least 100 sweeps that the mean (A) parameter readout is : **- 120 mV ± 3 %**.

Range	Conditions of Test		Offset Control	Mean Parameter Reading		
	PS Output	9314A Input		9314A Offset	Minimum value, -X %	Maximum Value, +X %
5 mV	- 120 mV	- 120 mV	+ 120 mV	- 116.4 mV	- 123.6 mV	3%
50 mV	- 1.2 V	- 1.2 V	+ 1.2 V	- 1.164 V	- 1.236 V	3%
5 V	- 20 V	- 20 V	+ 24 V	- 18.6 V	- 21.4V	7%

Table 5-6 : Positive offset control

11-Jul-94
14:37:22

Offset 1 = 120.00 mV

MEASURE

Average (1)
2 ms
5.0 mV
234 swps

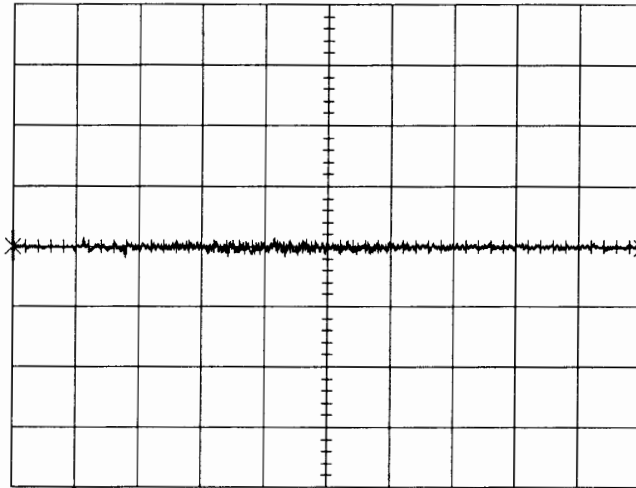

pkpk (A)	⊗	1.724 mV
mean (A)	⊗	-119.966 mV
sdev (A)	⊗	143.17 μV
rms (A)	⊗	119.966 mV
ampl (A)	⊗	1.72 mV

2 ms

1 5 mV DC
2 5 mV DC
3 5 mV DC
4 5 mV DC



1 DC -95.0 mV

Off Cursors
Parameters

mode
Std Voltage
Std Time
Custom
Pass
Fail

statistics
OFF On

on displayed (trace)
A

from
0.00 div
Track OFF On

to
10.00 div
5000 points

AUTO
2.5 Ms/s

- Set input gain to **50 mV/div.**, from the high precision voltage source, apply to Channel 1 the following voltage value : **- 1.2 V.**
- Using the offset control, move the Ch1 trace through the entire range until the following offset value is reached : **+ 1.2 V.**
- Verify that the displayed trace A : Average (1) is in the screen (near to the center horizontal graticule line).
- Press clear sweeps
- Check after at least 100 sweeps that the mean (A) parameter readout is : **- 1.2 V ±3 %** (see table 5-6).

Section 5 Performance Verification

11-Jul-94

16:30:22

Average(1)
2 ms
50 mV
104 swps

Offset 1 = 1.2000 V

MEASURE

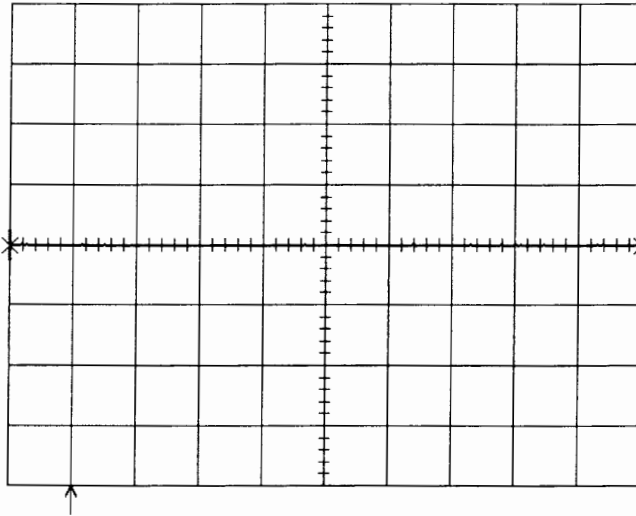

pkpk(A)	⊗	2.02 mV
mean(A)	⊗	-1.20005 V
sdev(A)	⊗	224.3 μV
rms(A)	⊗	1.20005 V
ampl(A)	⊗	2.0 mV

2 ms

- 1 50 mV DC
- 2 50 mV DC
- 3 50 mV DC
- 4 50 mV DC



1 DC -0.950 V

Off Cursors
Parameters

mode
Std Voltage
Std Time
Custom
Pass
Fail

statistics
Off On

on displayed
(trace)
A

from
0.00 div
Track Off On

to
10.00 div
5000 points

AUTO
2.5 Ms/s

- Set input gain to **5 V/div.**, from the high precision voltage source, apply to Channel 1 - **20 V** (maximum from PS5004).
- Using the offset control, move the Ch1 trace through the entire range until the maximum offset value is reached : **+ 24 V**.
- Verify that the displayed trace A : Average (1) is in the screen.
- Press clear sweeps
- Check after at least 100 sweeps that the mean (A) parameter readout is : **- 20 V ± 7 %** (see table 5-6).
- Repeat step 5.8.1.b for Channel 2, Channel 3 and Channel 4 substituting channel control and input connector.

5.9 Bandwidth

5.9.1 Description

The purpose of this test is to ensure that the entire system has a bandwidth of at least 400 MHz at 200 mV/div. An external source is used as the reference to provide a signal where amplitude and frequency are well controlled. A serious measurement of the bandwidth requires the use of a source whose amplitude does not change with frequency. The LeCroy calibration software corrects for the measured amplitude variation of the generator used. Generators can have errors of - 2 dB above 400 MHz. The non flatness of the generator should be taken into consideration.

Specifications

DC to at least 400 MHz (- 3 dB) at 200 mV/div. and above.

DC to at least 350 MHz below 200 mV/div.

DC to at least 300 MHz at 2 mV/div.

5.9.1.a DC 50 Ω

Procedure

- Turn on trace : **Ch1**
 - Display setup : **Standard, Persistence off, Dot join on, Single grid**
 - Input Coupling : **DC 50 Ω**
 - V/div. offset : **Normal**
 - Global BWL : **Off**
 - Probe atten : **X1**
 - Input gain : **100 mV/div.**
 - Offset : **0 mV**
 - Trigger setup : **Edge**
 - Trigger on : **Line**
 - Slope Line : **Pos**
 - Mode : **Norm**
 - Timebase : **10 μ sec/div.**
 - Record up : **50 K**
 - Press Cursors/Measure: **Parameters**
 - Mode : **Custom**
 - Statistics : **off**
 - Change parameters : **Measure**
 - On line 1 : **sdev of 1**
 - On line 2 : **freq of 1**
- Connect a leveled sine wave generator to Channel 1 (i.e. Marconi 2030), set the frequency to **500 KHz**, adjust the generator output amplitude to get on DSO : **sdev(1) = 140 mV.**

Section 5 Performance Verification

11-Jul-94
16:40:07

1
10 μ s
100 mV

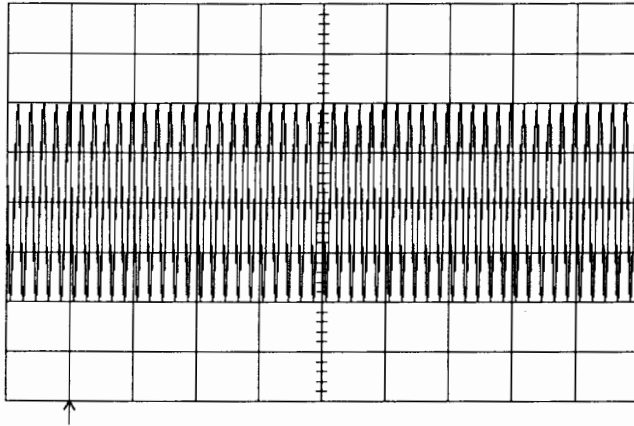

TRIGGER SETUP

Edge SMART

trigger on
1 2 3 4 Ext
Ext10 Line

Slope Line
Positive
Negative

sdev(1) $\sqrt{\quad}$ 140.51 mV
Freq(1) μ 500.0 kHz

10 μ s

- 1 .1 V 50 Ω
- 2 .1 V 50 Ω
- 3 .1 V 50 Ω
- 4 .1 V 50 Ω

Line

NORMAL
100 Ms/s

11-Jul-94
16:40:28

1
10 μ s
100 mV

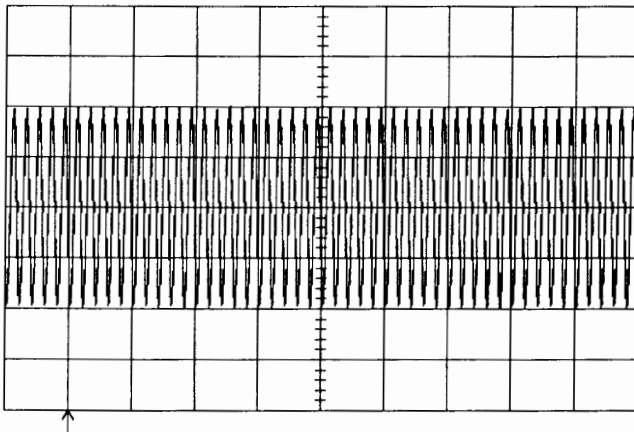

MEASURE

Off Cursors
Parameters

mode
Std Voltage
Std Time
Custom
Pass
Fail

statistics
OFF On

CHANGE
PARAMETERS

from
0.00 div
Track OFF On

to
10.00 div

sdev(1) $\sqrt{\quad}$ 140.55 mV
Freq(1) μ 500.0 kHz

10 μ s

- 1 .1 V 50 Ω
- 2 .1 V 50 Ω
- 3 .1 V 50 Ω
- 4 .1 V 50 Ω

Line

NORMAL
100 Ms/s

- Increase the generator frequency in multi **50 MHz** steps until the sine wave amplitude is 70% of the initial amplitude at 500 KHz .
- At each 50 MHz step, check that **sdev(1) > 98 mV**
- When **sdev(1) = 98 mV (3 dB point)** the frequency of the generator must be at least **350 MHz**.

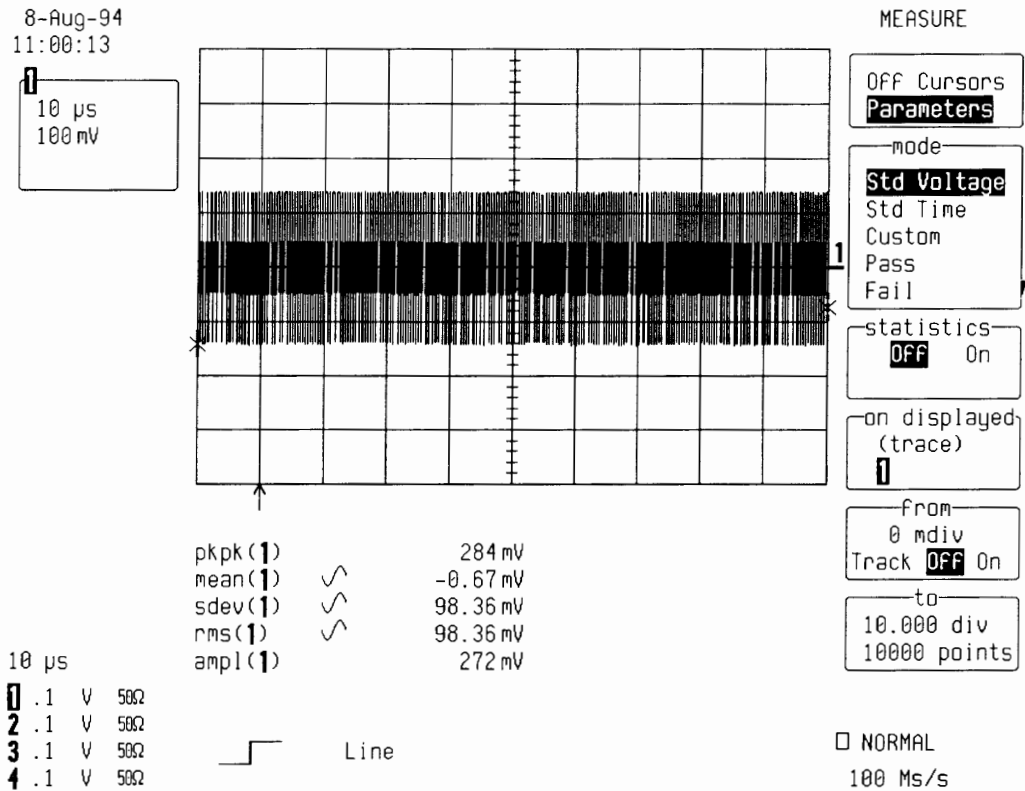

- Select Coupling Channel 1
 - Global BWL : **On** (bandwidth limiter on)
 - Trigger on : **Channel 1**
 - Coupling 1 : **DC**
 - Slope 1 : **Pos**
 - Timebase : **20 nsec/div**
- Check that the frequency at the 3 dB point (**sdev(1) = 98 mV**) is typically **30 MHz** . (between 22 MHz and 43 MHz).

Section 5 Performance Verification

8-Aug-94
11:09:07

20 ns
100 mV

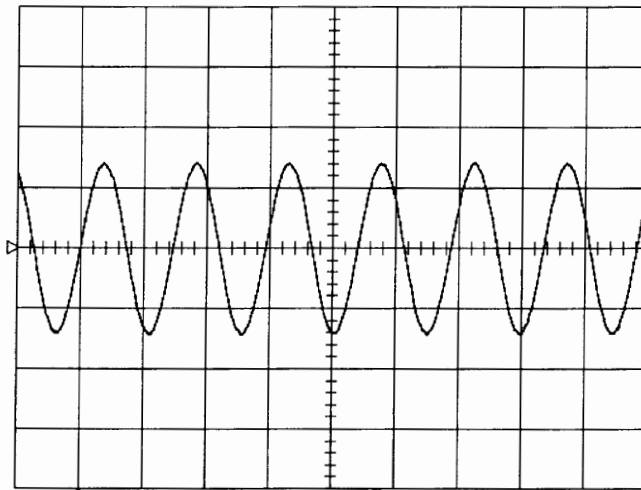

sdev(1) $\sqrt{\quad}$ 99.39 mV
freq(1) $\Pi\Pi$ 34.01 MHz

CHANNEL 1
Coupling
DC50 Ω
Grounded
DC1M Ω
Grounded
AC1M Ω
V/div Offset
NORMAL
ECL TTL
Global BWL
OFF **On**
(30 MHz)

Probe Atten
x1
x2
x5
x10
x20

20 ns RIS BWL

1 .1 V 50 Ω
2 .1 V 50 Ω
3 .1 V 50 Ω
4 .1 V 50 Ω

 1 DC 0 mV

NORMAL
10 Gs/s

- Set DSO Input gain : **200 mV/div.**
- Select Coupling Channel 1
- Global BWL : **Off** (bandwidth limiter off)
- Trigger on : **Line**
- Mode : **Norm**
- Timebase : **10 μ sec/div.**

- Set sine wave generator frequency to **500 KHz**, adjust the generator output amplitude to get on DSO : **sdev(1) = 282 mV.**

- Increase the generator frequency in multi **50 MHz** steps until the sine wave amplitude is 70% of the initial amplitude at 500 KHz .

- At each 50 MHz step, check that **sdev(1) > 198 mV**

- When **sdev(1) = 198 mV (3 dB point)** the frequency of the generator must be at least **400 MHz.**

1-Jul-94
16:53:54

1
10 μ s
200 mV

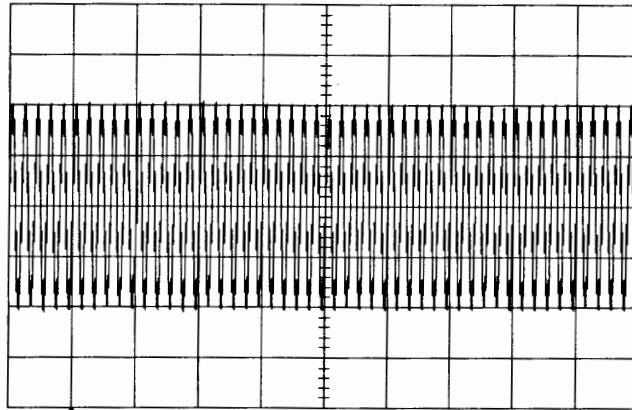

sdev(1) \checkmark 282.239 mV
freq(1) Ω 500.0 kHz

10 μ s
1 .2 V 50 Ω
2 .2 V 50 Ω

Line

MEASURE

Off Cursors
Parameters

mode
Std Voltage
Std Time
Custom
Pass
Fail

statistics
OFF On

CHANGE
PARAMETERS

from
0.00 div
Track OFF On

to
10.00 div

500 MS/s

NORMAL

1-Jul-94
16:55:55

1
10 μ s
200 mV

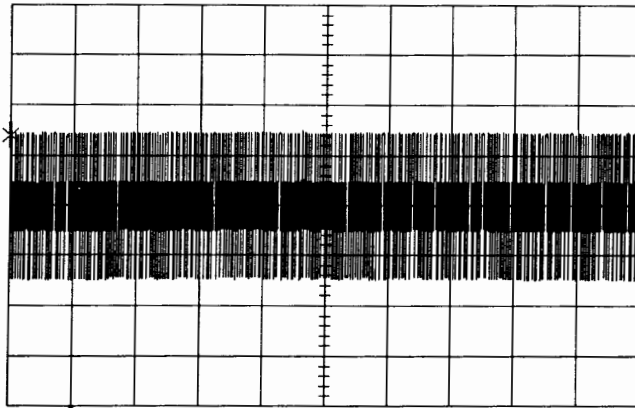

pkpk(1) 600 mV
mean(1) -195 μ V
sdev(1) 199.697 mV
rms(1) 199.695 mV
ampl(1) 539 mV

10 μ s
1 .2 V 50 Ω
2 .2 V 50 Ω

Line

MEASURE

Off Cursors
Parameters

mode
Std Voltage
Std Time
Custom
Pass
Fail

statistics
OFF On

on displayed
(trace)

from
0.00 div
Track OFF On

to
10.00 div
50000 pts

500 MS/s

NORMAL

5.9.1.a.1 Trigger Bandwidth

- Set Trigger on : **1**
- Coupling 1 : **HF**
- Mode : **Norm**
- Timebase : **1 nsec/div.**

- Set sine wave generator frequency to **501 MHz**

- Change Trigger level, until the scope triggers on Channel 1.

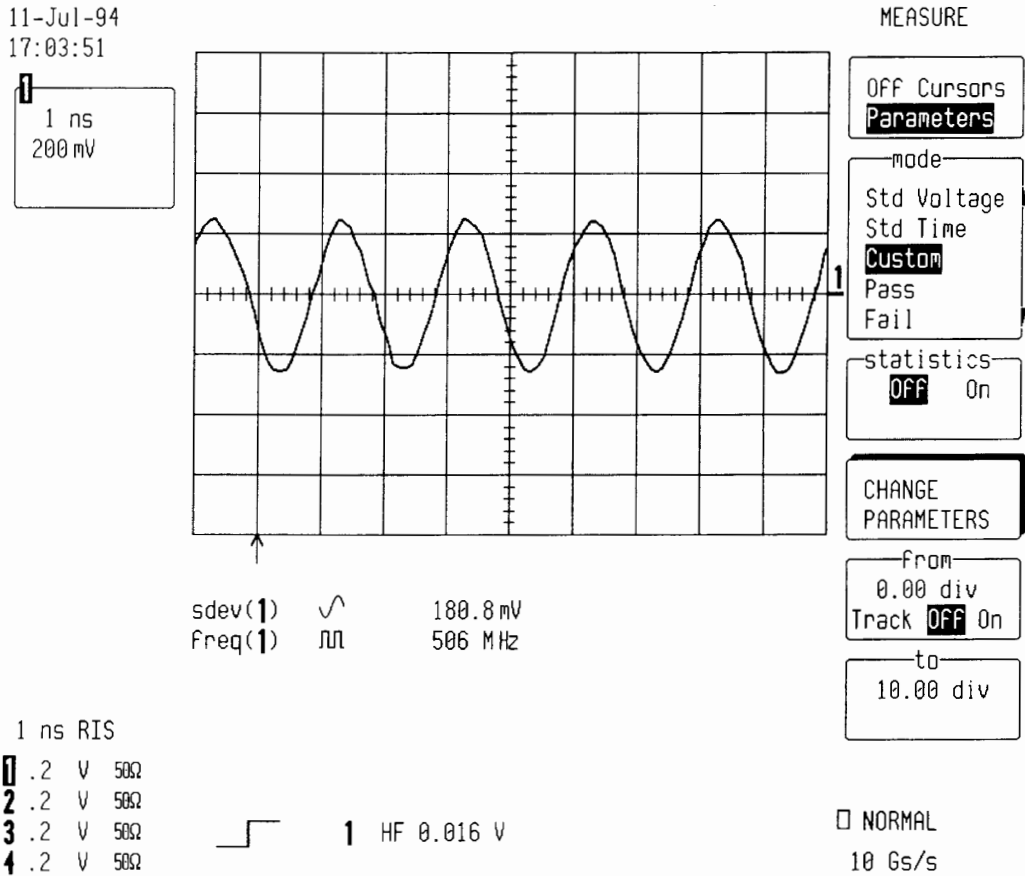

- Check : The scope must keep triggering in a stable way, a smooth sine wave must be visible on the screen.

- Repeat step 5.9.1.a and 5.9.1.a.1 for Channel 2, Channel 3 and Channel 4, substituting channel control and input connector.

5.9.1.b DC 1 M Ω

The purpose of this test is to ensure that the entire 9314A/M/L system has a bandwidth of at least **250 MHz at probe tip**.

Set up a Tektronix SG503 leveled sine wave generator or equivalent.

- Terminate the output of the SG503 via a **50 Ω feed through** and connect it to the channel 1 input through a **10X-probe** using a probe tip BNC Jack adapter. Make sure the probe compensation is perfectly adjusted at low frequency.

- Turn on trace : **Ch1**
- Display setup : **Standard, Persistence off, Dot join on, Single grid**
- Input Coupling : **AC 1M Ω**
- V/div. offset : **Normal**
- Global BWL : **Off**
- Probe atten : **X10**
- Input gain : **1 V/div.**
- Offset : **0 mV**
- Trigger setup : **Edge**
- Trigger on : **Line**
- Slope Line : **Pos**
- Mode : **Norm**
- Timebase : **10 μ sec/div.**
- Record up : **50 K**

- Press Cursors/Measure: **Parameters**
- Mode : **Custom**
- Statistics : **off**
- Change parameters : **Measure**
- On line 1 : **sdev of 1**
- On line 2 : **freq of 1**

- Set sine wave generator frequency to **500 KHz**, adjust the generator output amplitude to get on DSO : **sdev(1) = 1.8 V**.

- Increase the generator frequency in multi **MHz** steps until the sine wave amplitude is 70% of the initial amplitude at 500 KHz .

- At each frequency step, check that **sdev(1) > 1.25 V**

- When **sdev(1) = 1.25 V (3 dB point)** the frequency of the generator must be at least **250 MHz**.

Section 5 Performance Verification

11-Jul-94
17:15:19

10 μ s
1.00 V

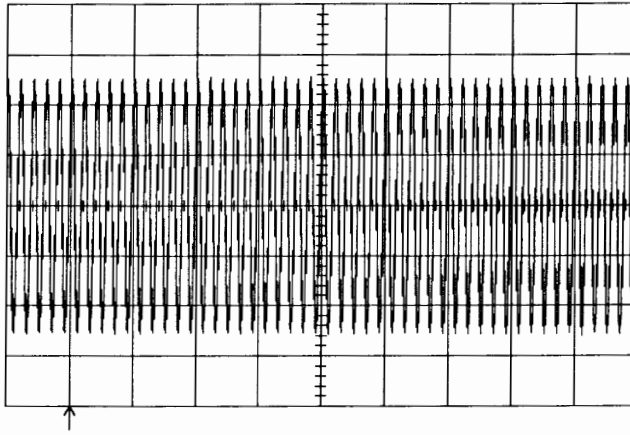

sdev(1) $\sqrt{\quad}$ 1.8025 V
freq(1) Π 499.5 kHz

CHANNEL 1

Coupling
DC50 Ω
Grounded
DC1M Ω
Grounded
AC1M Ω

V/div Offset
NORMAL
ECL TTL

Global BWL
OFF On
(30 MHz)

Probe sensed
(x10)

10 μ s

- 1 .1 V AC \times
- 2 1 V AC
- 3 1 V AC
- 4 1 V AC

Line

NORMAL
100 Ms/s

11-Jul-94
17:18:20

10 μ s
1.00 V

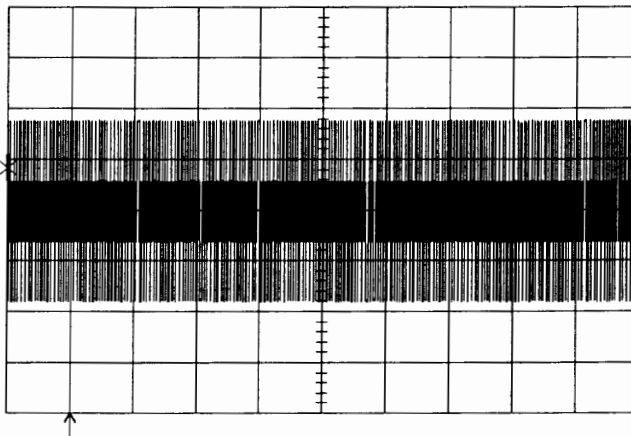

pkpk(1) 3.50 V
mean(1) -13.4 mV
sdev(1) 1.2507 V
rms(1) 1.2507 V
ampl(1) 3.50 V

MEASURE

OFF Cursors
Parameters

mode
Std Voltage
Std Time
Custom
Pass
Fail

statistics
OFF On

on displayed
(trace)
1

from
0.00 div
Track **OFF** On

to
10.00 div
10000 points

10 μ s

- 1 .1 V AC \times
- 2 1 V AC
- 3 1 V AC
- 4 1 V AC

Line

NORMAL
100 Ms/s

- Set the bandwidth limiter on :
- Select Coupling Channel 1
 - Global BWL : **On** (bandwidth limiter on)
 - Trigger on : **Channel 1**
 - Coupling 1 : **DC**
 - Slope 1 : **Pos**
 - Timebase : **20 nsec/div**
- Check that the frequency at the 3 dB point ($sdev(1) = 1.25 \text{ V}$) is typically **30 MHz** (between 22 MHz and 43 MHz).

11-Jul-94
17:19:51

20 ns
1.00 V

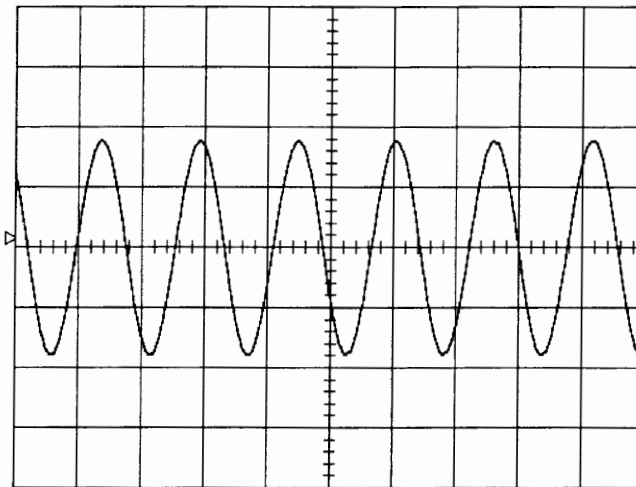

CHANNEL 1

Coupling
DC50Ω
Grounded
DC1MΩ
Grounded
AC1MΩ

V/div Offset
NORMAL
ECL TTL

Global BWL
OFF **On**
(30 MHz)

Probe sensed
(x10)

$sdev(1)$ $\sqrt{\quad}$ 1.2517 V
 $Freq(1)$ Ω 32.04 MHz

20 ns RIS BWL

- .1 V AC \times
- 2** 1 V AC
- 3** 1 V AC
- 4** 1 V AC

DC 0.16 V

NORMAL
10 Gs/s

- Repeat step 5.9.1.b for Channel 2, Channel 3, and Channel 4 substituting channel control and input connector.

5.10 Trigger Level

5.10.1 Description

The trigger capabilities are tested for several cases of the standard edge trigger :

- Channel (internal), and External Trigger sources
- Three DC levels : - 3, 0, - 3 major screen divisions
- DC coupling
- Positive and negative slopes

5.10.2 Channel (internal)

The horizontal and vertical errors for a trigger at 0 V threshold are determined by comparing the crossing point of the same sine wave at two different amplitudes.

- Setup any sine wave generator capable of generating sine waves of **1 KHz**, 4 V pkpk.
- Connect the generator output to Channel 1

- Turn on trace : **Ch1**
- Input Coupling Ch 1 : **DC 50 Ω**
- V/div. offset : **Normal**
- Input gain : **.5 V/div.**
- Input offset : **0 mV**
- Trigger setup : **Edge**
- Trigger on : **1**
- Coupling 1 : **DC**
- Slope 1 : **Pos**
- Set Trigger level : **DC 0.0 mV**
- Mode : **Single**
- Pre-Trigger Delay : **50 %**
- Timebase : **.1 msec/div.**
- Record up to : **50 K samples**

- Adjust the sine wave generator's output amplitude to get **8 divisions peak to peak**, corresponding to a **4 V** amplitude.
- It is important that the offset of the input is set to **zero mV**, use show status and acquisition status to verify.

- Display setup : **Dot join Off**
- Set **Persistence On**, and acquire few sweeps in Single Trigger mode.
- Connect a **3 dB attenuator**, and acquire few more sweeps in Single mode.

- Select Cursors/Measure : **Cursors, Time, Absolute**
- Use the " cursor position " knob, to move the marker at the **horizontal crossing point** of the two sine waves.

- Check that the **time** difference obtained between the marker and the trigger is within $\pm 20 \mu \text{ sec}$. The time readout is below 0.50 V in the icon **1**, at top left.

8-Aug-94
13:19:09

1 .1 ms
0.50 V

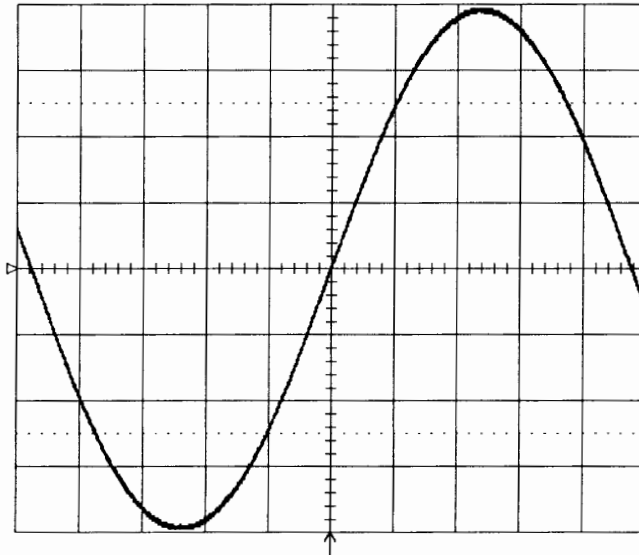

DISPLAY SETUP

- Standard XY
- Persistence OFF On (Infinite)
- Dot Join OFF On
- Persistence Setup**
- Grids Single Dual Quad
- W'Form+Text intensity 90 %
- Grid intensity 60 %

- .1 ms
- 1** .5 V 50Ω
- 2** .5 V 50Ω
- 3** .5 V 50Ω
- 4** .5 V 50Ω

STOPPED
50 Ms/s

8-Aug-94
13:19:56

1 .1 ms
0.50 V
-2 μs

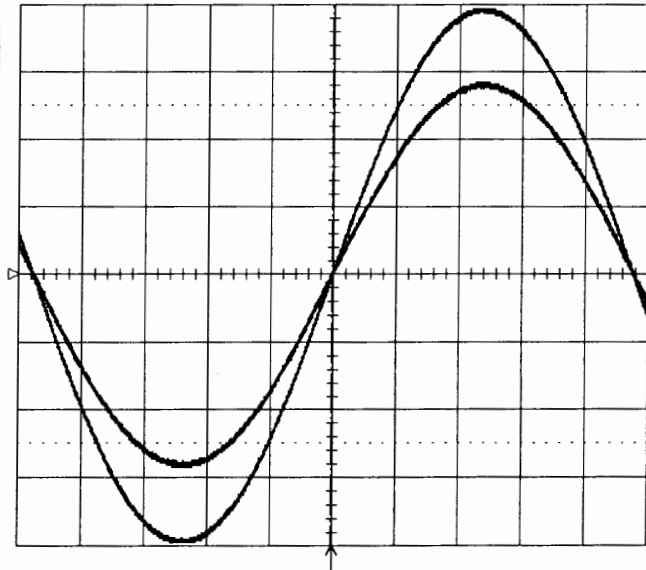

MEASURE

- OFF Cursors (Parameters)
- mode Time Amplitude
- type Relative Absolute

cursor Position

- .1 ms
- 1** .5 V 50Ω
- 2** .5 V 50Ω
- 3** .5 V 50Ω
- 4** .5 V 50Ω

STOPPED
50 Ms/s

Section 5 Performance Verification

- Select Cursors mode : **Amplitude, Absolute**
- Use the " cursor position " knob, to move the marker at the **vertical crossing point** of the two sine waves.
- Check that the **voltage** difference obtained between the marker and the trigger level is within ± 200 mV. The level readout is below 0.50 V in the icon 1, at top left.

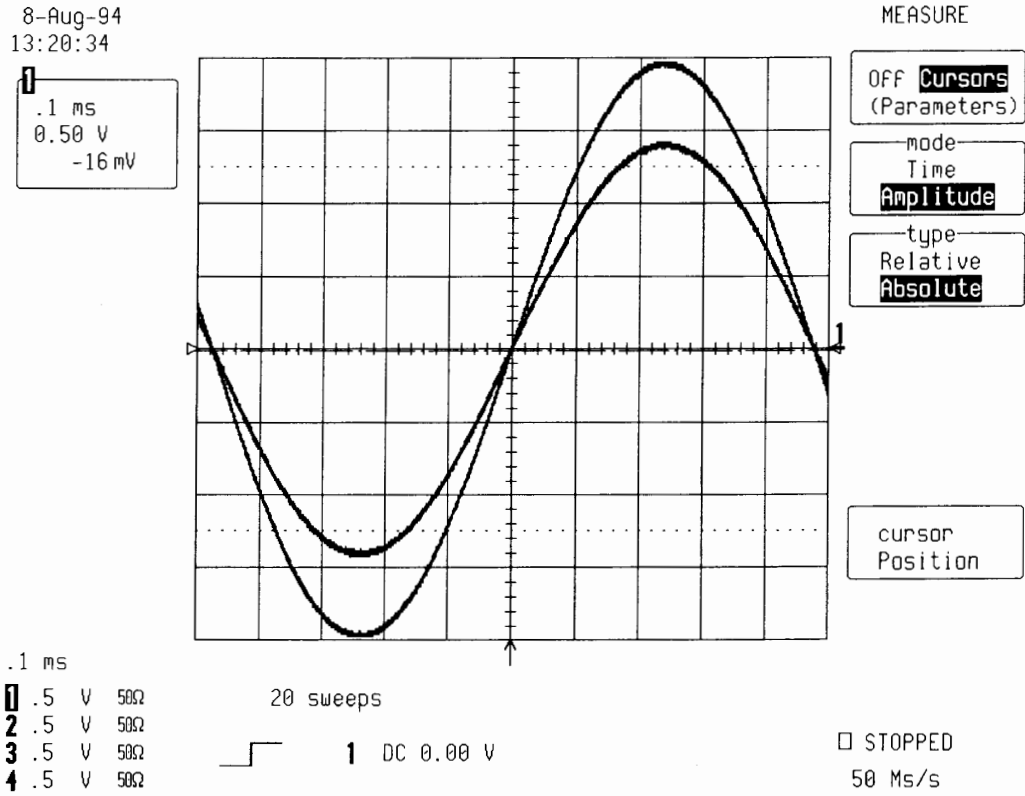

- Set Trigger Slope 1 : **Neg**
- Disconnect the **3 dB attenuator** from the BNC input
- Acquire few sweeps in Single Trigger mode.
- Connect the **3 dB attenuator**, and acquire few more sweeps in Single mode.
- Select Cursors/Measure : **Cursors, Time, Absolute**
- Use the " cursor position " knob, to move the marker at the **horizontal crossing point** of the two sine waves.
- Check that the **time** difference obtained between the marker and the trigger is within ± 20 μ sec. The time readout is below 0.50 V in the icon 1, at top left.
- Select Cursors mode : **Amplitude, Absolute**
- Use the " cursor position " knob, to move the marker at the **vertical crossing point** of the two sine waves.
- Check that the **voltage** difference obtained between the marker and the trigger level is within ± 200 mV. The level readout is below 0.50 V in the icon 1, at top left.

8-Aug-94
13:21:52

1
.1 ms
0.50 V
2 μ s

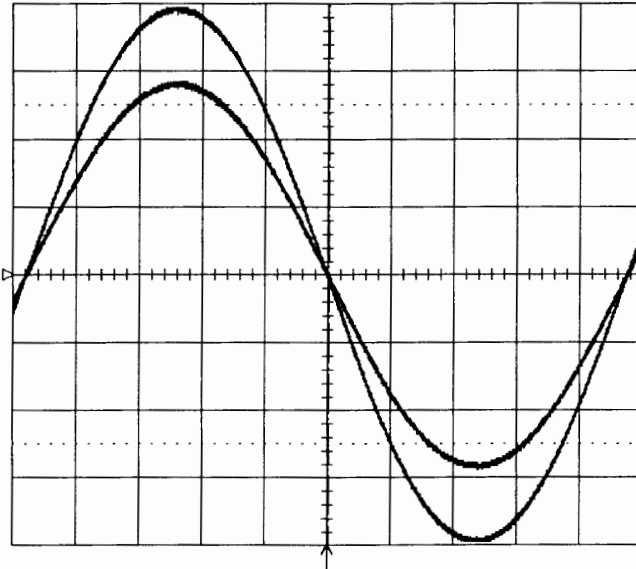

TRIGGER SETUP

Edge SMART
trigger on **1 2 3 4** Ext Ext10 Line
coupling **1** DC AC LFREJ HFREJ HF
slope **1** Pos Neg Window
holdoff
OFF Time Evts

.1 ms
1 .5 V 50 Ω
2 .5 V 50 Ω
3 .5 V 50 Ω
4 .5 V 50 Ω

20 sweeps

1 DC 0.00 V

STOPPED
50 Ms/s

8-Aug-94
13:22:29

1
.1 ms
0.50 V
8 mV

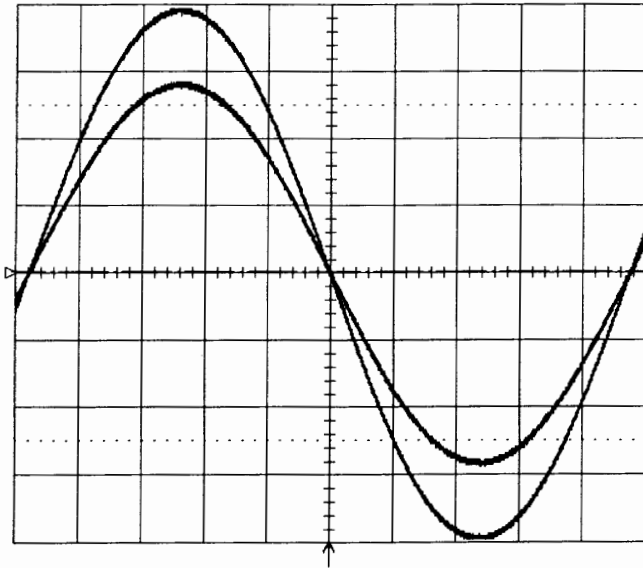

MEASURE

OFF **Cursors** (Parameters)
mode
Time
Amplitude
type
Relative
Absolute
cursor
Position

.1 ms
1 .5 V 50 Ω
2 .5 V 50 Ω
3 .5 V 50 Ω
4 .5 V 50 Ω

20 sweeps

1 DC 0.00 V

STOPPED
50 Ms/s

Section 5 Performance Verification

- Set Trigger level : **DC + 1.5 V**
- Disconnect the **3 dB attenuator** from the BNC input
- Set Trigger Slope 1 : **Pos**

- Acquire few sweeps in Single Trigger mode.

- The sine wave must pass through the **horizontal center** of the screen at the **vertical + 3 divisions**.

- Select Cursors/Measure : **Cursors, Amplitude, Absolute**

- Use the " cursor position " knob, to move the marker, at the **crossing point** of the **sine wave** and the **horizontal center of the screen** (50% pre-trigger line).

- Check that the **vertical crossing point level is + 1.5 V ± .2 V**. See icon 1 at top left.

8-Aug-94
13:28:01

1
.1 ms
0.50 V
1.461 V

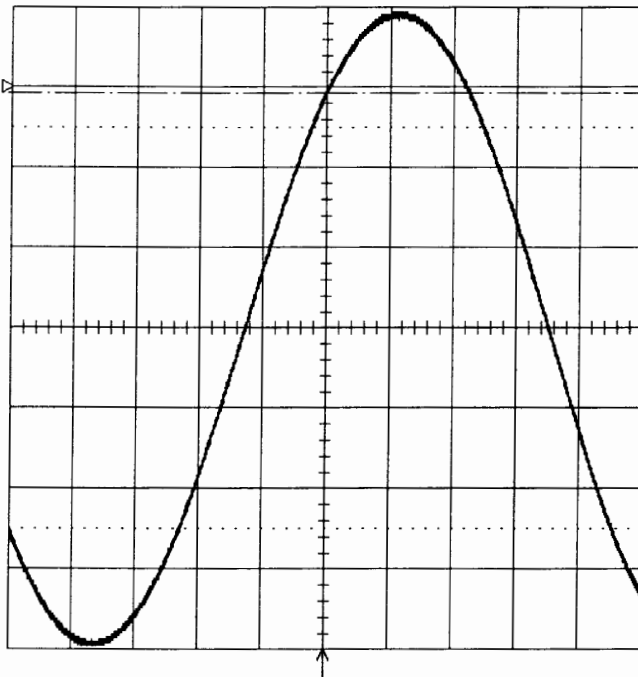

MEASURE

OFF **Cursors**
(Parameters)

mode
Time
Amplitude

type
Relative
Absolute

cursor
Position

.1 ms

- 1 .5 V 50Ω
- 2 .5 V 50Ω
- 3 .5 V 50Ω
- 4 .5 V 50Ω

10 sweeps

1 DC 1.50 V

□ STOPPED
50 Ms/s

- Set Trigger Slope 1 : **Neg**
- Acquire few sweeps in Single Trigger mode.
- The sine wave must pass through the **horizontal center** of the screen at the **vertical + 3 divisions**.
- Select Cursors/Measure : **Cursors, Amplitude, Absolute**
- Use the " cursor position " knob, to move the marker, at the **crossing point** of the **sine wave** and the **horizontal center of the screen** (50% pre-trigger line).
- Check that the **vertical crossing point level is + 1.5 V ± .2 V**. See icon at top left.

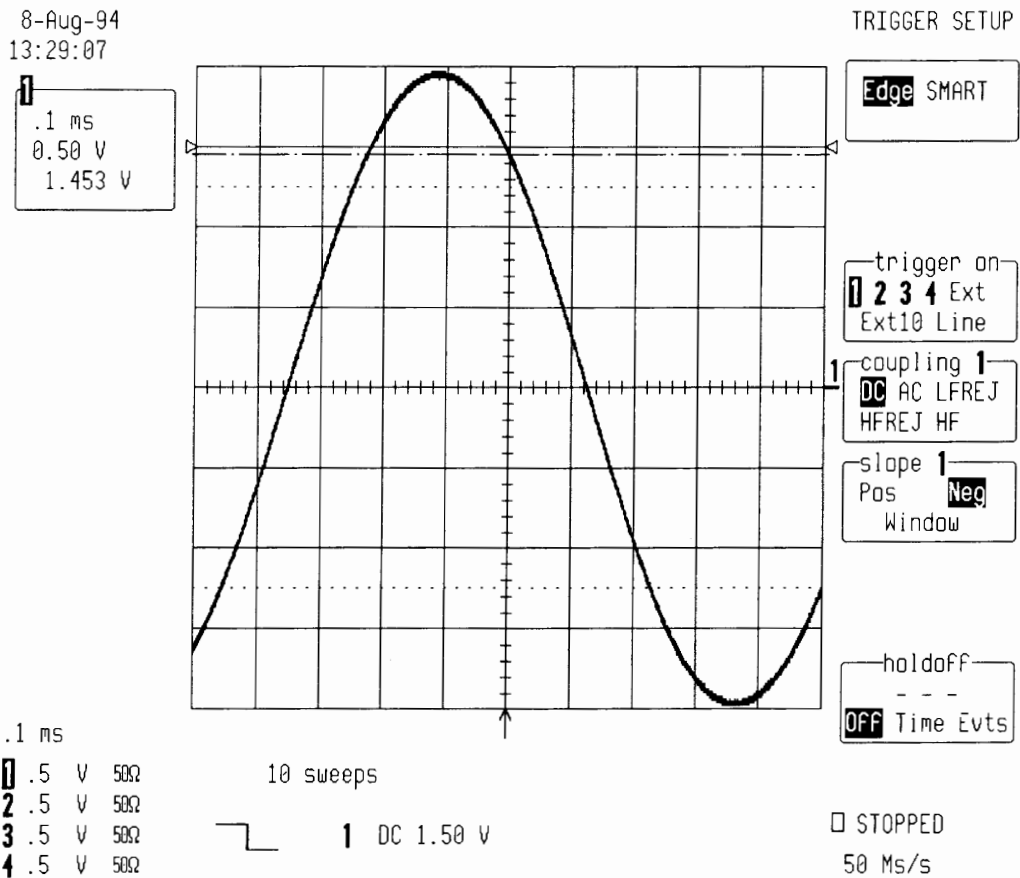

Section 5 Performance Verification

- Set Trigger level : **DC - 1.5 V**
- Set Trigger Slope 1 : **Pos**
- Acquire few sweeps in Single Trigger mode.
- The sine wave must pass through the **horizontal center** of the screen at the **vertical - 3 divisions**.
- Select Cursors/Measure : **Cursors, Amplitude, Absolute**
- Use the " cursor position " knob, to move the marker, at the **crossing point** of the **sine wave** and the **horizontal center of the screen** (50% pre-trigger line).
- Check that the **vertical crossing point level is - 1.5 V ± .2 V**. See icon 1 at top left.

8-Aug-94
13:31:13

1
.1 ms
0.50 V
-1.484 V

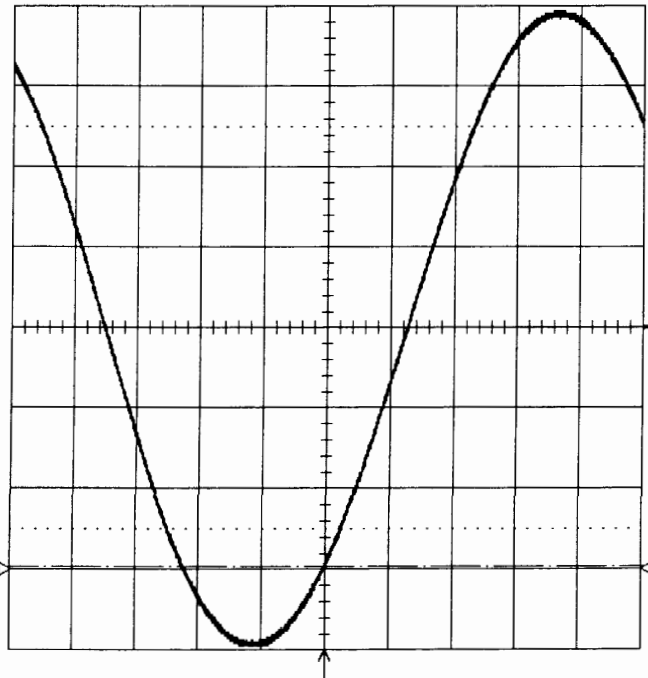

TRIGGER SETUP

Edge SMART

trigger on
1 2 3 4 Ext
Ext10 Line

coupling **1**
DC AC LFREJ
HFREJ HF

slope **1**
Pos Neg
Window

holdoff
- - -
OFF Time Evts

.1 ms
1 .5 V 50Ω
2 .5 V 50Ω
3 .5 V 50Ω
4 .5 V 50Ω

10 sweeps

1 DC -1.50 V

STOPPED
50 Ms/s

5.10.3 External Trigger

Specifications

External trigger range : DC \pm .5 V

Procedure

- Connect the output of the generator to External input and to Channel 2 via a coaxial T-connector. The cable length from External to Channel 2 must be short, at most 2 nsec.

- Set frequency : **1 KHz**
- Turn on trace : **Ch2**
- Input Coupling Ch 2 : **DC 50 Ω**
- V/div. offset : **Normal**
- Input gain : **100 mV/div.**
- Input offset : **0 mV**
- Trigger setup : **Edge**
- Trigger on : **Ext**
- Coupling Ext : **DC**
- Slope Ext : **Pos**
- External : **DC 1M Ω**
- Set Ext Trigger level : **DC 0.0 mV**
- Mode : **Single**
- Pre-Trigger Delay : **50 %**
- Timebase : **.1 msec/div.**
- Record up to : **50 K samples**

- Adjust the sine wave generator's output amplitude to get **8 divisions peak to peak**, corresponding to a **.8 V** amplitude.
- It is important that the offset of the input is set to **zero mV**, use show status and acquisition status to verify.

- Display setup : **Dot join Off**
- Set **Persistence On**, and acquire few sweeps in Single Trigger mode.

- Connect a **3 dB attenuator**, and acquire few more sweeps in Single mode.

- Select Cursors/Measure : **Cursors, Time, Absolute**
- Use the " cursor position " knob, to move the marker at the **horizontal crossing point** of the two sine waves.

- Check that the **time** difference obtained between the marker and the trigger is within **\pm 20 μ sec**. The time readout is below 100 mV in the icon **2**, at top left.

8-Aug-94
13:39:05

2
.1 ms
100 mV

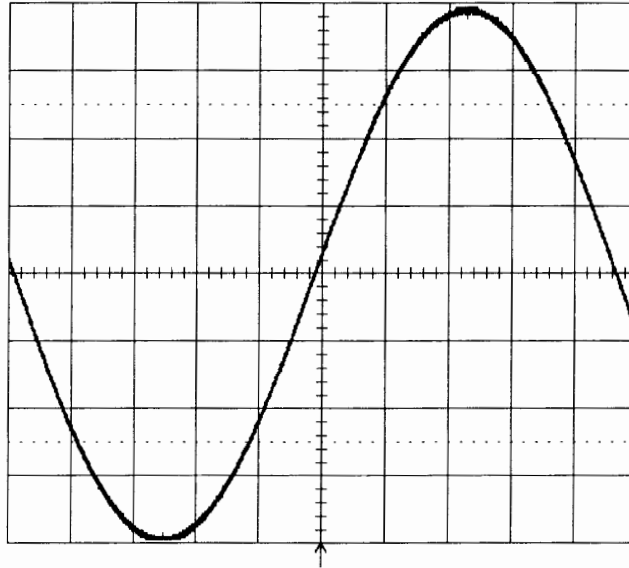

TRIGGER SETUP

Edge SMART

trigger on
1 2 3 4 Ext
Ext10 Line

cp1g Ext
DC AC LFREJ
HFREJ HF

slope Ext
Pos Neg
Window

External
atten x1
DC50Ω DC1MΩ

holdoff
- - -
OFF Time Evts

.1 ms
1 .5 V 50Ω
2 .1 V 50Ω
3 .5 V 50Ω
4 .5 V 50Ω

10 sweeps

Ext DC 0mV 1MΩ

STOPPED
50 Ms/s

8-Aug-94
13:41:15

2
.1 ms
100 mV
2 μs

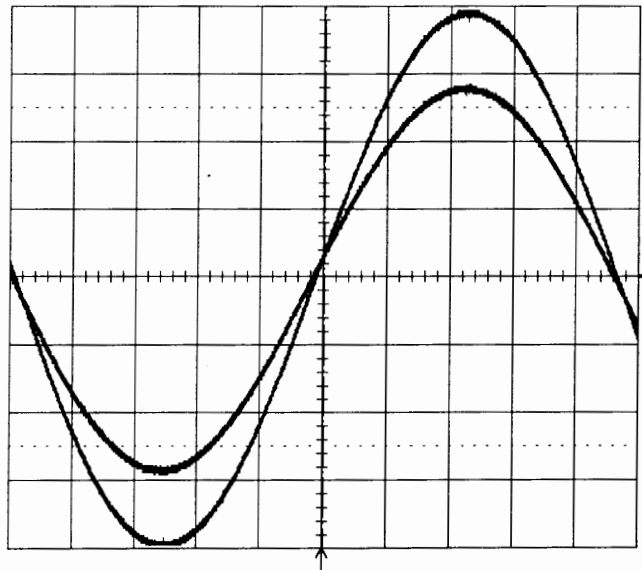

MEASURE

OFF Cursors
(Parameters)

mode
Time
Amplitude

type
Relative
Absolute

cursor
Position

.1 ms
1 .5 V 50Ω
2 .1 V 50Ω
3 .5 V 50Ω
4 .5 V 50Ω

21 sweeps

Ext DC 0mV 1MΩ

STOPPED
50 Ms/s

- Select Cursors mode : **Amplitude, Absolute**
- Use the " cursor position " knob, to move the marker at the vertical crossing point of the two sine waves.
- Check that the **vertical crossing point level is within ± 40 mV**. See icon 2 at top left.

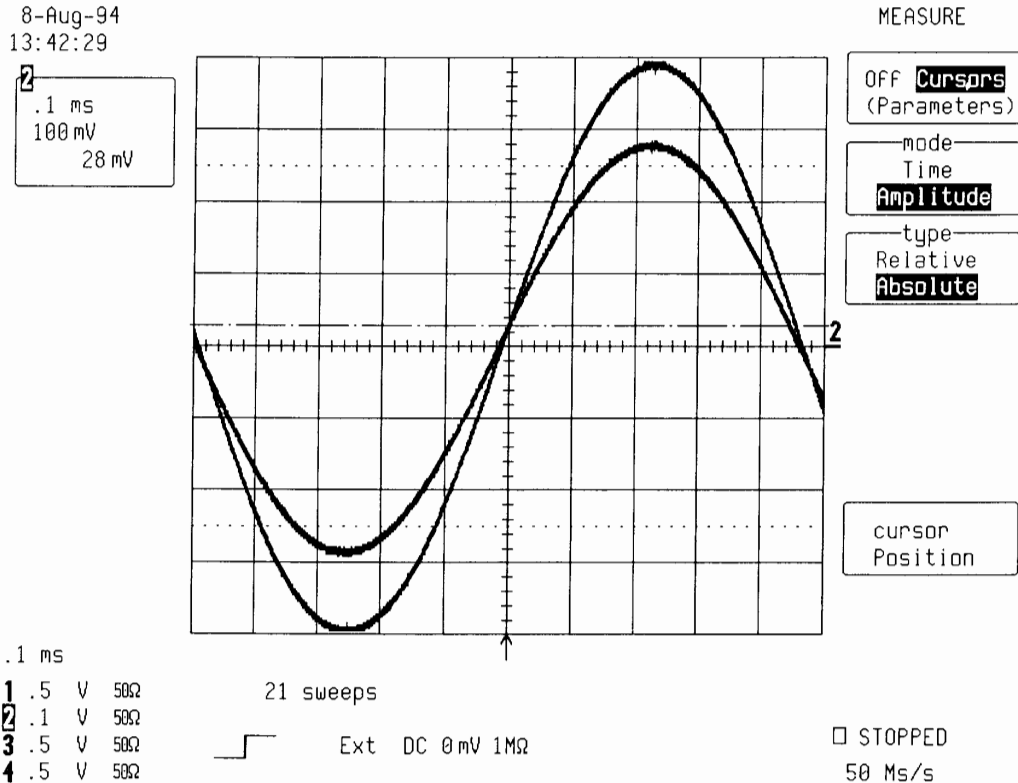

- Set Slope Ext : **Neg**
- Disconnect the **3 dB attenuator** from the BNC input
- Acquire few sweeps in Single Trigger mode.
- Connect the **3 dB attenuator**, and acquire few more sweeps in Single mode.
- Select Cursors/Measure : **Cursors, Time, Absolute**
- Use the " cursor position " knob, to move the marker at the **horizontal crossing point** of the two sine waves.
- Check that the **time** difference obtained between the marker and the trigger is within $\pm 20 \mu$ sec. The time readout is below 100 mV in the icon 2, at top left.

8-Aug-94
13:44:01

2
.1 ms
100 mV

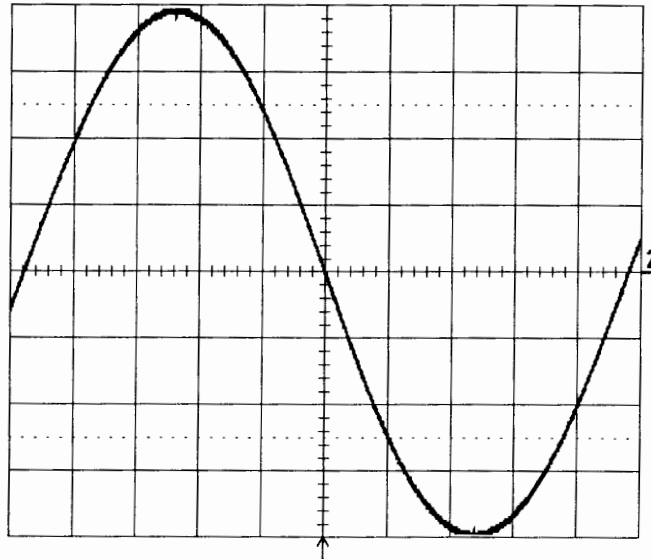

TRIGGER SETUP

Edge SMART

trigger on
1 2 3 4 Ext
Ext10 Line

cpig Ext
DC AC LFREJ
HFREJ HF

slope Ext
Pos Neg
Window

External
atten x1
DC50Ω DC1MΩ

holdoff
OFF Time Evts

- .1 ms
- 1 .5 V 50Ω
 - 2 .1 V 50Ω
 - 3 .5 V 50Ω
 - 4 .5 V 50Ω

10 sweeps

Ext DC 0mV 1MΩ

STOPPED
50 Ms/s

8-Aug-94
13:45:05

2
.1 ms
100 mV
-2 μs

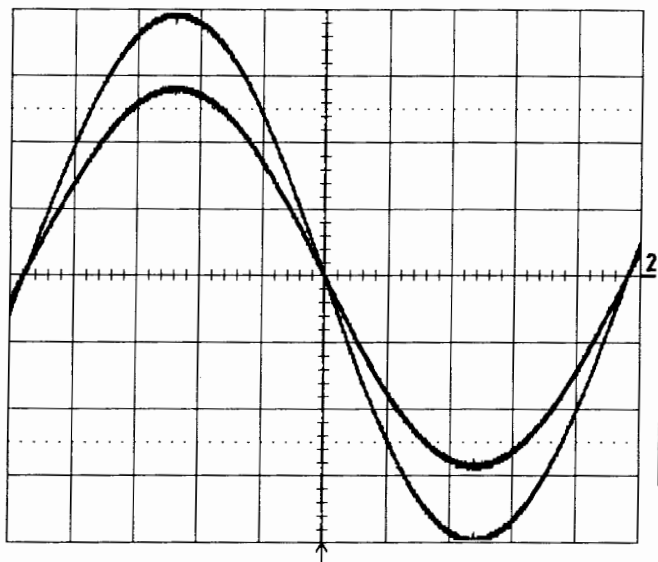

MEASURE

OFF Cursors
(Parameters)

mode
Time
Amplitude

type
Relative
Absolute

cursor
Position

- .1 ms
- 1 .5 V 50Ω
 - 2 .1 V 50Ω
 - 3 .5 V 50Ω
 - 4 .5 V 50Ω

21 sweeps

Ext DC 0mV 1MΩ

STOPPED
50 Ms/s

- Select Cursors mode : **Amplitude, Absolute**
- Use the " cursor position " knob, to move the marker at the **vertical crossing point** of the two sine waves.
- Check that the **voltage** difference obtained between the marker and the trigger level is within $\pm 40 \text{ mV}$. The level readout is below 100 mV in the icon 2, at top left.

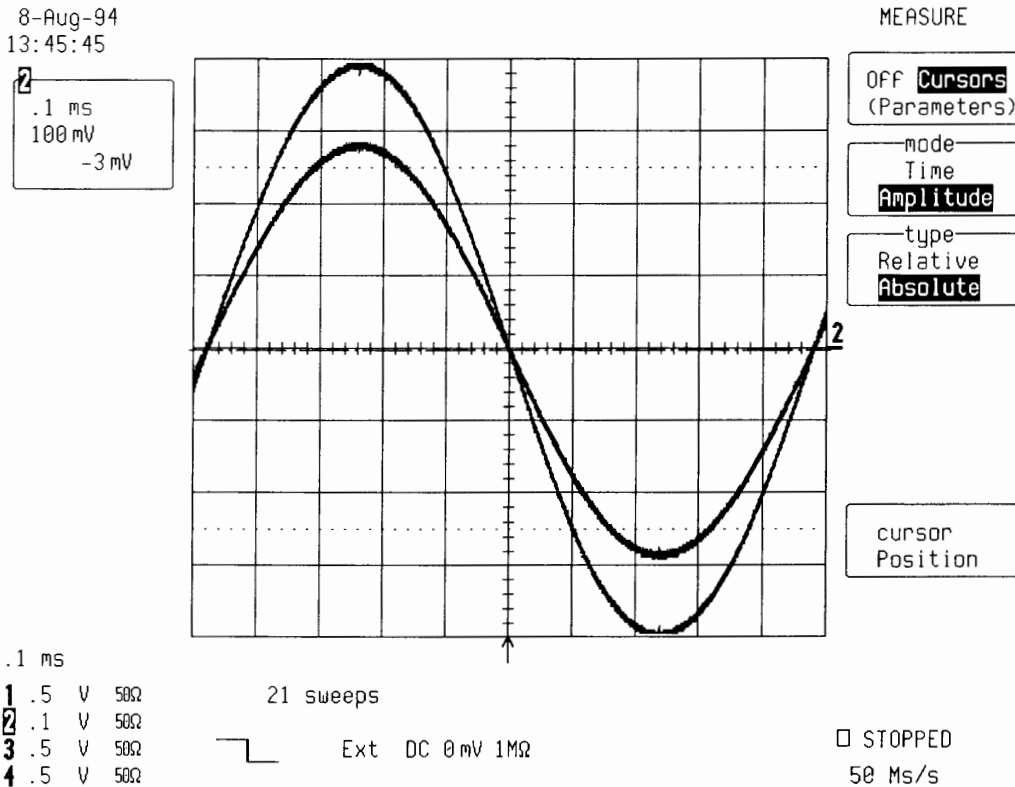

- Set Trigger level : **DC + 300 mV**
- Disconnect the **3 dB attenuator** from the BNC input
- Set Trigger Slope Ext : **Pos**
- Acquire few sweeps in Single Trigger mode.
- The sine wave must pass through the **horizontal center** of the screen at the **vertical + 3 divisions**.
- Select Cursors/Measure : **Cursors, Amplitude, Absolute**
- Use the " cursor position " knob, to move the marker, at the **crossing point** of the **sine wave** and the **horizontal center of the screen** (50% pre-trigger line).
- Check that the **vertical crossing point level** is $+ 300 \text{ mV} \pm 40 \text{ mV}$. See icon 2 at top.

8-Aug-94
13:47:26

2
.1 ms
100 mV
328 mV

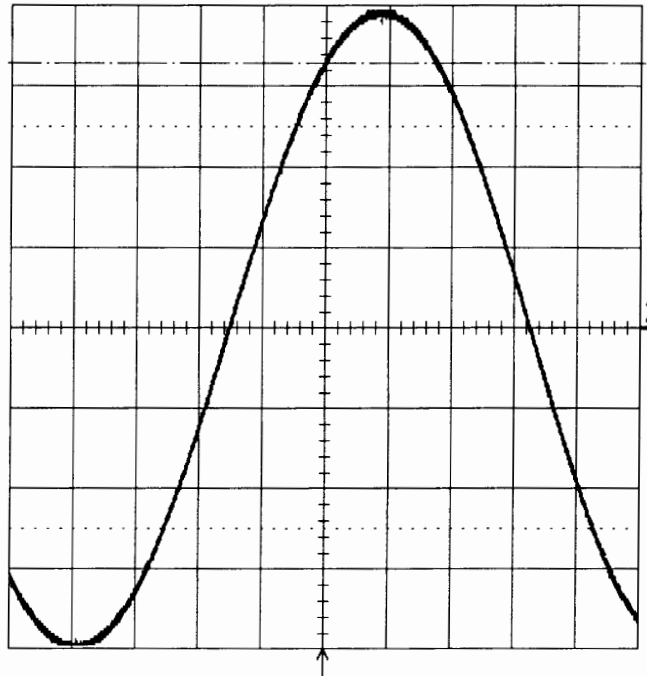

MEASURE

OFF **Cursors**
(Parameters)

mode
Time
Amplitude

type
Relative
Absolute

cursor
Position

.1 ms

- 1 .5 V 50Ω
- 2 .1 V 50Ω
- 3 .5 V 50Ω
- 4 .5 V 50Ω

11 sweeps



Ext DC 300 mV 1MΩ

□ STOPPED

50 Ms/s

- Set Trigger Slope Ext : **Neg**
- Acquire few sweeps in Single Trigger mode.
- The sine wave must pass through the **horizontal center** of the screen at the **vertical + 3 divisions**.
- Select Cursors/Measure : **Cursors, Amplitude, Absolute**
- Use the " cursor position " knob, to move the marker, at the **crossing point** of the **sine wave** and the **horizontal center of the screen** (50% pre-trigger line).
- Check that the **vertical crossing point level is + 300 mV ± 40 mV**. See icon 2 at top .

8-Aug-94
13:49:32

TRIGGER SETUP

2
.1 ms
100 mV
297 mV

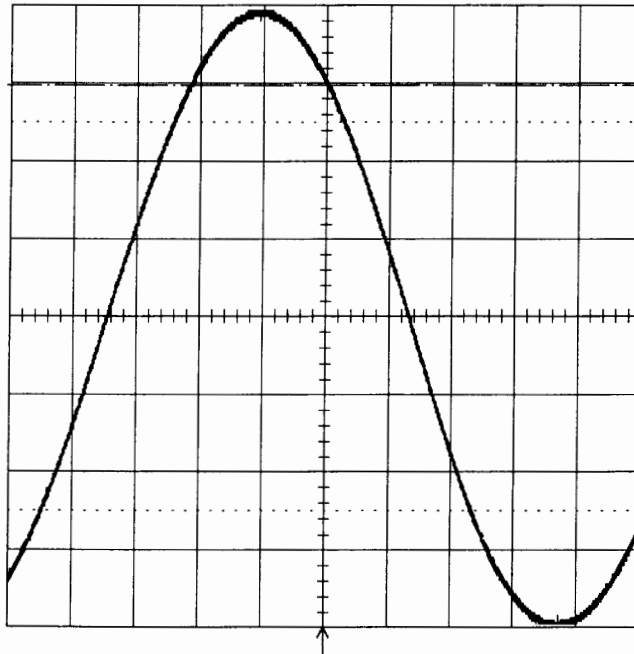

Edge SMART

trigger on
1 2 3 4 Ext
Ext10 Line

2
cplg Ext
DC AC LFREJ
HFREJ HF

slope Ext
Pos Neg
Window

External
atten x1
DC50Ω DC1MΩ

holdoff
- - -
OFF Time Evts

.1 ms

- 1 .5 V 50Ω
- 2 .1 V 50Ω
- 3 .5 V 50Ω
- 4 .5 V 50Ω

11 sweeps

Ext DC 300 mV 1MΩ

□ STOPPED
50 Ms/s

- Set Trigger level : **DC - 300 mV**
- Set Trigger Slope Ext : **Pos**
- Acquire few sweeps in Single Trigger mode.
- The sine wave must pass through the **horizontal center** of the screen at the **vertical - 3 divisions**.
- Select Cursors/Measure : **Cursors, Amplitude, Absolute**
- Use the " cursor position " knob, to move the marker, at the **crossing point** of the **sine wave** and the **horizontal center of the screen** (50% pre-trigger line).
- Check that the **vertical crossing point level is - 300 mV ± 40 mV**. See icon 2 at top.

- Set Trigger Slope Ext : **Neg**
- Acquire few sweeps in Single Trigger mode.
- The sine wave must pass through the **horizontal center** of the screen at the **vertical - 3 divisions**.
- Select Cursors/Measure : **Cursors, Amplitude, Absolute**
- Use the " cursor position " knob, to move the marker, at the **crossing point** of the **sine wave** and the **horizontal center of the screen** (50% pre-trigger line).
- Check that the **vertical crossing point level is - 300 mV ± 40 mV**. See icon 2 at top.

8-Aug-94
13:50:46

2
.1 ms
100 mV
-277 mV

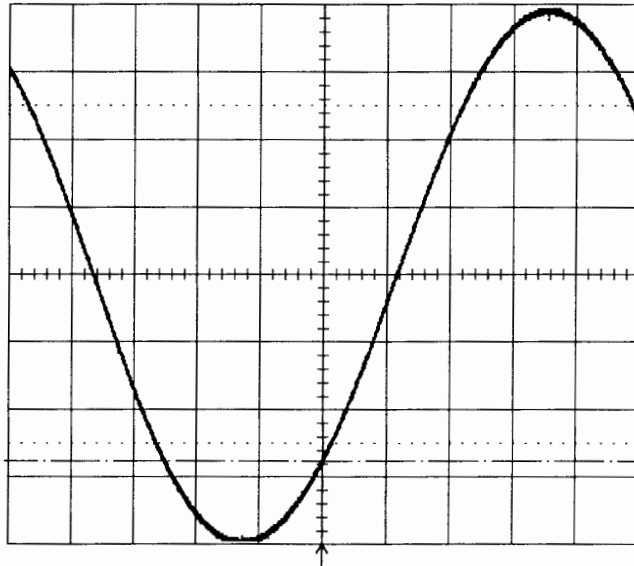

10 sweeps

Ext DC -300 mV 1M Ω

.1 ms

- 1 .5 V 50 Ω
- 2 .1 V 50 Ω
- 3 .5 V 50 Ω
- 4 .5 V 50 Ω

TRIGGER SETUP

Edge SMART

trigger on
1 2 3 4 Ext
Ext10 Line

cplg Ext
DC AC LFREJ
HFREJ HF

slope Ext
Pos Neg
Window

External
atten x1
DC50 Ω DC1M Ω

holdoff
- - -
OFF Time EvtS

STOPPED
50 Ms/s

8-Aug-94
13:52:31

2
.1 ms
100 mV
-305 mV

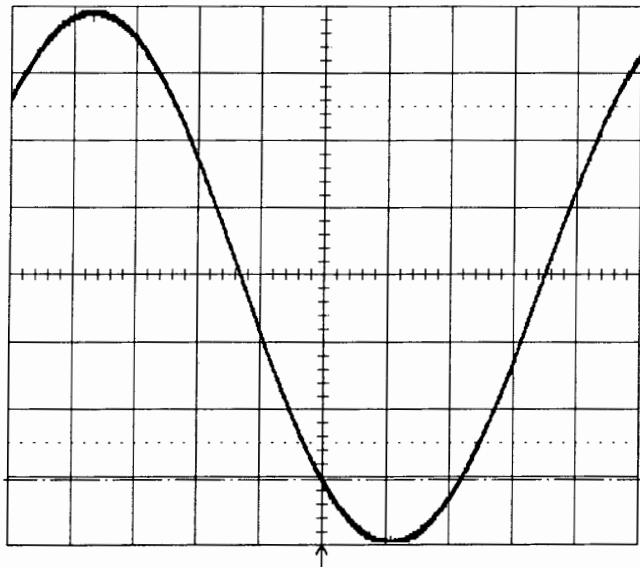

10 sweeps

Ext DC -300 mV 1M Ω

.1 ms

- 1 .5 V 50 Ω
- 2 .1 V 50 Ω
- 3 .5 V 50 Ω
- 4 .5 V 50 Ω

TRIGGER SETUP

Edge SMART

trigger on
1 2 3 4 Ext
Ext10 Line

cplg Ext
DC AC LFREJ
HFREJ HF

slope Ext
Pos Neg
Window

External
atten x1
DC50 Ω DC1M Ω

holdoff
- - -
OFF Time EvtS

STOPPED
50 Ms/s

5.10.4 External /10 Trigger

Specifications

External trigger range : DC \pm 5 V

Procedure

- Connect the output of the generator to External input and to Channel 2 via a coaxial T-connector. The cable length from External to Channel 2 must be short, at most 2 nsec.
- Set frequency : **1 KHz**

- Turn on trace : **Ch2**
- Input Coupling Ch 2 : **DC 50 Ω**
- V/div. offset : **Normal**
- Input gain : **1 V/div.**
- Input offset : **0 mV**
- Trigger setup : **Edge**
- Trigger on : **Ext10**
- Coupling Ext10 : **DC**
- Slope Ext10 : **Pos**
- External : **DC 1M Ω**
- Set Ext Trigger level : **DC 0.0 mV**
- Mode : **Single**
- Pre-Trigger Delay : **50 %**
- Timebase : **.1 msec/div.**
- Record up to : **50 K samples**

- Adjust the sine wave generator's output amplitude to get **8 divisions peak to peak**, corresponding to a **8 V** amplitude.
- It is important that the offset of the input is set to **zero mV**, use show status and acquisition status to verify.

- Display setup : **Dot join Off**
- Set **Persistence On**, and acquire few sweeps in Single Trigger mode.

- Connect a **3 dB attenuator**, and acquire few more sweeps in Single mode.

- Select Cursors/Measure : **Cursors, Time, Absolute**

- Use the " cursor position " knob, to move the marker at the **horizontal crossing point** of the two sine waves.

- Check that the **time** difference obtained between the marker and the trigger is within **\pm 20 μ sec**. The time readout is below 1 V in the icon **2**, at top left.

8-Aug-94
14:50:25

2
.1 ms
1.00 V
2 μ s

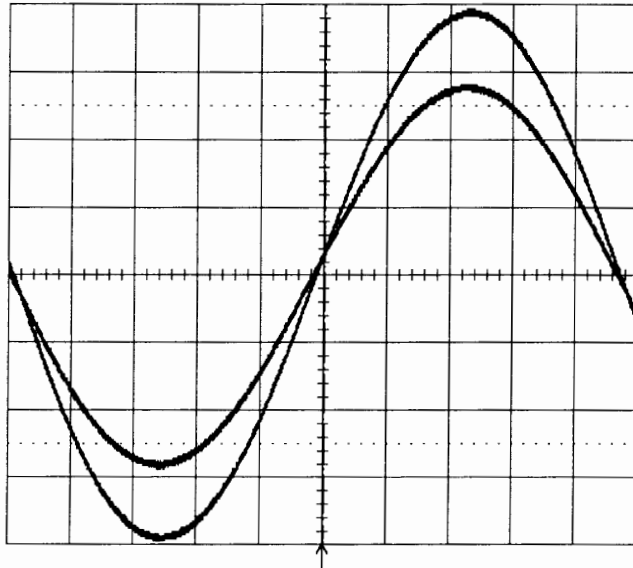

MEASURE

OFF **Cursors**
(Parameters)

mode
Time
Amplitude

type
Relative
Absolute

cursor
Position

.1 ms

- 1 1 V 50 Ω
- 2 1 V 50 Ω
- 3 1 V 50 Ω
- 4 1 V 50 Ω

20 sweeps
Ext10 DC 0.00 V 1M Ω

STOPPED
50 Ms/s

8-Aug-94
14:51:27

2
.1 ms
1.00 V
0.25 V

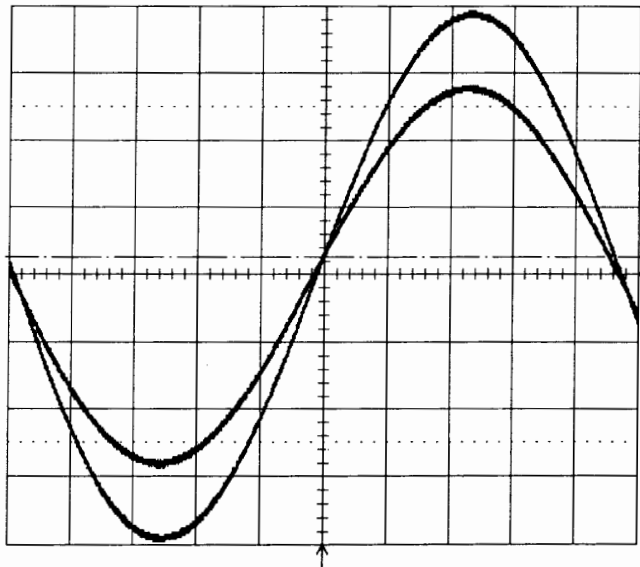

MEASURE

OFF **Cursors**
(Parameters)

mode
Time
Amplitude

type
Relative
Absolute

cursor
Position

.1 ms

- 1 1 V 50 Ω
- 2 1 V 50 Ω
- 3 1 V 50 Ω
- 4 1 V 50 Ω

20 sweeps
Ext10 DC 0.00 V 1M Ω

STOPPED
50 Ms/s

- Select Cursors mode : **Amplitude, Absolute**
- Use the " cursor position " knob, to move the marker at the **vertical crossing point** of the two sine waves.
- Check that the **voltage** difference obtained between the marker and the trigger level is within ± 500 mV. The level readout is below 1 V in the icon 2, at top left.

- Set Trigger Slope Ext10 : **Neg**
- Disconnect the **3 dB attenuator** from the BNC input
- Acquire few sweeps in Single Trigger mode.
- Connect the **3 dB attenuator**, and acquire few more sweeps in Single mode.
- Select Cursors/Measure : **Cursors, Time, Absolute**
- Use the " cursor position " knob, to move the marker at the **horizontal crossing point** of the two sine waves.
- Check that the **time** difference obtained between the marker and the trigger is within ± 20 μ sec. The time readout is below 1 V in the icon 2, at top left.

- Select Cursors mode : **Amplitude, Absolute**
- Use the " cursor position " knob, to move the marker at the **vertical crossing point** of the two sine waves.
- Check that the **vertical crossing point level is within ± 500 mV**. See icon 2 at left.

8-Aug-94
14:54:19

2
.1 ms
1.00 V
-2 μ s

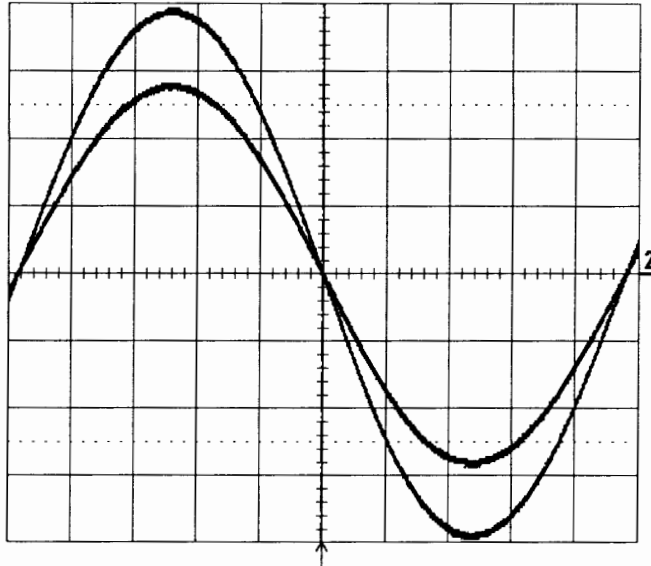

TRIGGER SETUP

Edge SMART

trigger on
1 2 3 4 Ext
Ext10 Line

cp1g Ext10
DC AC LFREJ
HFREJ HF

slope Ext10
Pos Neg
Window

External
atten x1
DC50 Ω DC1M Ω

holdoff
OFF Time Evts

.1 ms

- 1 1 V 50 Ω
- 2 1 V 50 Ω
- 3 1 V 50 Ω
- 4 1 V 50 Ω

22 sweeps



Ext10 DC 0.00 V 1M Ω

STOPPED
50 Ms/s

8-Aug-94
14:54:57

2
.1 ms
1.00 V
-0.05 V

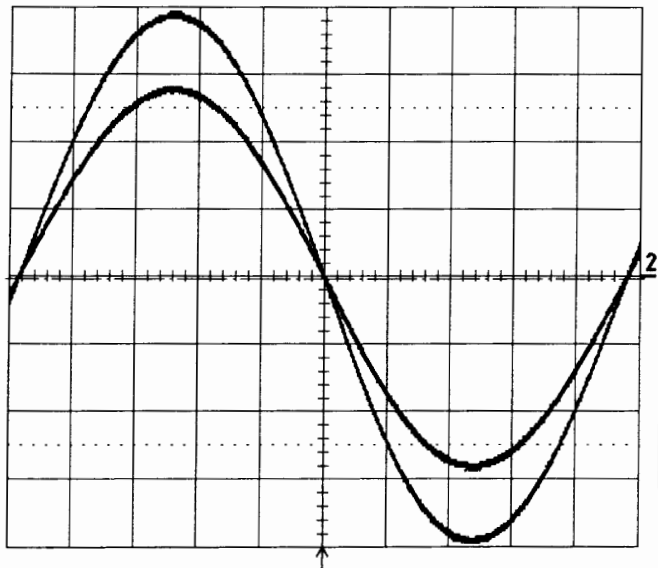

MEASURE

OFF Cursors
(Parameters)

mode
Time
Amplitude

type
Relative
Absolute

cursor
Position

.1 ms

- 1 1 V 50 Ω
- 2 1 V 50 Ω
- 3 1 V 50 Ω
- 4 1 V 50 Ω

22 sweeps



Ext10 DC 0.00 V 1M Ω

STOPPED
50 Ms/s

Section 5 Performance Verification

- Set Trigger level : **DC + 3 V**
- Set Trigger Slope Ext10 : **Pos**
- Disconnect the **3 dB attenuator** from the BNC input
- Acquire few sweeps in Single Trigger mode.
- The sine wave must pass through the **horizontal center** of the screen at the **vertical + 3 divisions**.
- Select Cursors/Measure : **Cursors, Amplitude, Absolute**
- Use the " cursor position " knob, to move the marker, at the **crossing point** of the **sine wave** and the **horizontal center of the screen** (50% pre-trigger line).
- Check that the **vertical crossing point level is + 3 V ± 500 mV**. See icon **2** at top.

8-Aug-94
14:56:59

2
.1 ms
1.00 V
3.30 V

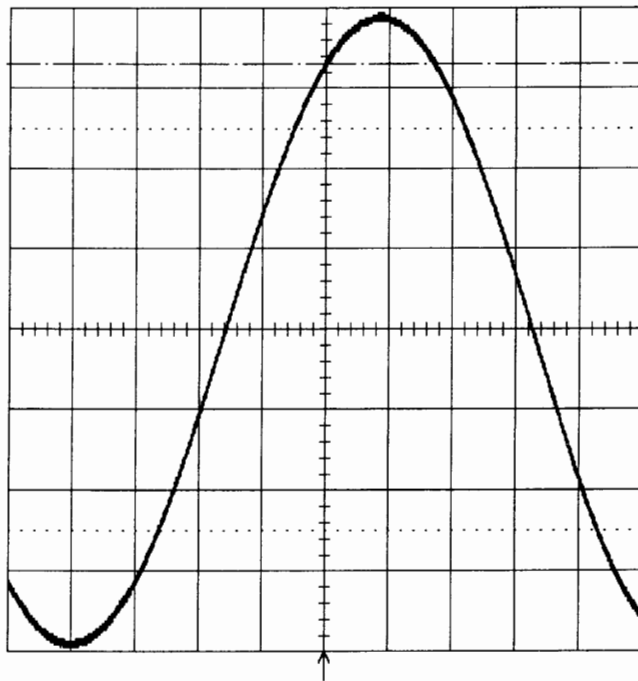

TRIGGER SETUP

Edge SMART

trigger on
1 2 3 4 Ext
Ext10 Line

cplg Ext10
DC AC LFREJ
HFREJ HF

slope Ext10
Pos Neg
Window

External
atten **x1**
DC50Ω **DC1MΩ**

holdoff
- - -
OFF Time Evts

.1 ms

- 1** 1 V 50Ω
- 2** 1 V 50Ω
- 3** 1 V 50Ω
- 4** 1 V 50Ω

10 sweeps



Ext10 DC 3.00 V 1MΩ

STOPPED
50 Ms/s

- Set Trigger Slope Ext10 : **Neg**
- Acquire few sweeps in Single Trigger mode.
- The sine wave must pass through the **horizontal center** of the screen at the **vertical + 3 divisions**.
- Select Cursors/Measure : **Cursors, Amplitude, Absolute**
- Use the " cursor position " knob, to move the marker, at the **crossing point** of the **sine wave** and the **horizontal center of the screen** (50% pre-trigger line).
- Check that the **vertical crossing point level is + 3 V ± 500 mV**. See icon 2 at top .

8-Aug-94
15:00:08

2
.1 ms
1.00 V
3.03 V

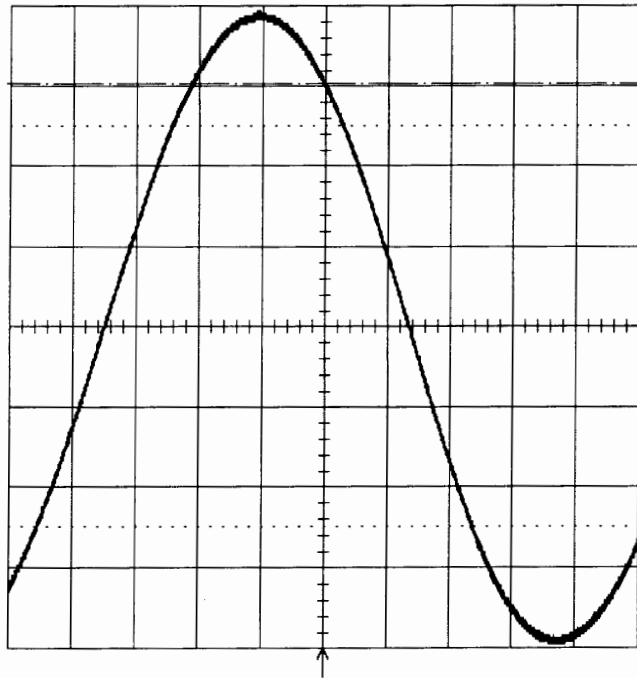

TRIGGER SETUP

Edge SMART

trigger on
1 2 3 4 Ext
Ext10 Line

2 cplg Ext10
DC AC LFREJ
HFREJ HF

slope Ext10
Pos **Neg**
Window

External
atten **x1**
DC50Ω **DC1MΩ**

holdoff
- - -
OFF Time Evts

.1 ms

- 1** 1 V 50Ω
- 2** 1 V 50Ω
- 3** 1 V 50Ω
- 4** 1 V 50Ω

10 sweeps

Ext10 DC 3.00 V 1MΩ

STOPPED
50 Ms/s

Section 5 Performance Verification

- Set Trigger level : **DC - 3 V**
- Trigger Slope Ext10 : **Pos**
- Acquire few sweeps in Single Trigger mode.
- The sine wave must pass through the **horizontal center** of the screen at the **vertical - 3 divisions**.
- Select Cursors/Measure : **Cursors, Amplitude, Absolute**
- Use the " cursor position " knob, to move the marker, at the **crossing point** of the **sine wave** and the **horizontal center of the screen** (50% pre-trigger line).
- Check that the **vertical crossing point level is - 3 V ± 500 mV**. See icon 2 at top.

8-Aug-94
15:03:52

2
.1 ms
1.00 V
-2.77 V

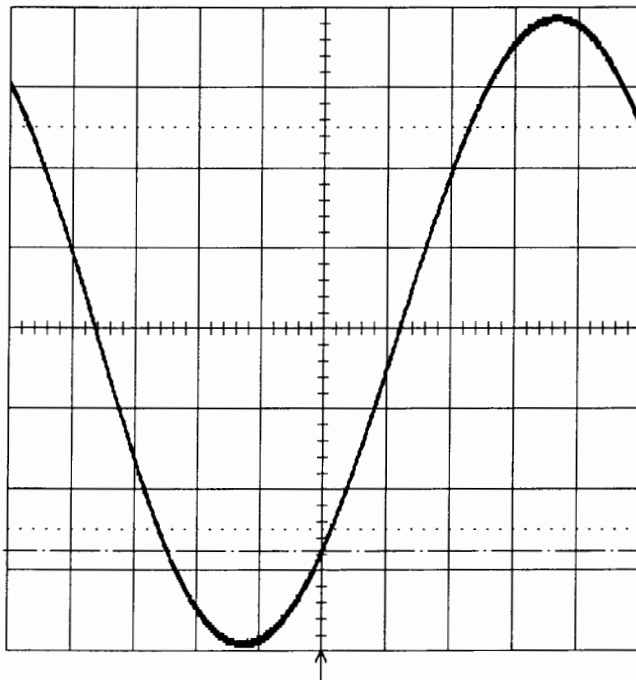

TRIGGER SETUP

Edge SMART

trigger on
1 2 3 4 Ext
Ext10 Line

2
cp1g Ext10
DC AC LFREJ
HFREJ HF

slope Ext10
Pos Neg
Window

External
atten x1
DC50Ω DC1MΩ

holdoff
- - -
OFF Time EvtS

.1 ms

- 1 1 V 50Ω
- 2 1 V 50Ω
- 3 1 V 50Ω
- 4 1 V 50Ω

10 sweeps

Ext10 DC -3.00 V 1MΩ

□ STOPPED

50 Ms/s

- Trigger Slope Ext10 : **Neg**
- Acquire few sweeps in Single Trigger mode.
- The sine wave must pass through the **horizontal center** of the screen at the **vertical - 3 divisions**.
- Select Cursors/Measure : **Cursors, Amplitude, Absolute**
- Use the " cursor position " knob, to move the marker, at the **crossing point** of the **sine wave** and the **horizontal center of the screen** (50% pre-trigger line).
- Check that the **vertical crossing point level is - 3 V ± 500 mV**. See icon 2 at top.

8-Aug-94
15:02:45

2
.1 ms
1.00 V
-3.03 V

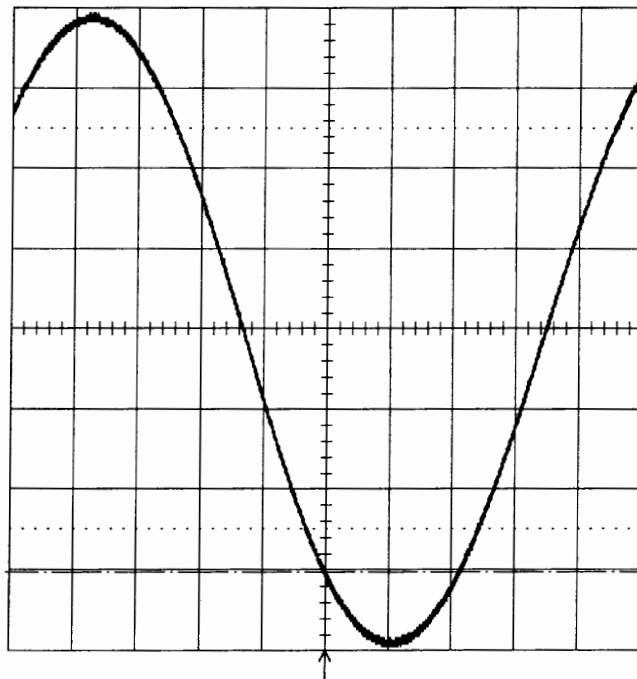

TRIGGER SETUP

Edge SMART

trigger on
1 2 3 4 Ext
Ext10 Line

cplg Ext10
DC AC LFREJ
HFREJ HF

slope Ext10
Pos Neg
Window

External
atten x1
DC50Ω DC1MΩ

holdoff
- - -
OFF Time Evts

- .1 ms
- 1 1 V 50Ω
 - 2 1 V 50Ω
 - 3 1 V 50Ω
 - 4 1 V 50Ω

10 sweeps

Ext10 DC -3.00 V 1MΩ

STOPPED
50 Ms/s

5.11 Smart Trigger

Specifications

Pulse width < or > 2.5 nsec to 20 sec.

5.11.1 Trigger on Pulse Width < 10 nsec

Procedure

- Connect a leveled sine wave generator to Channel 1

- Frequency : **100 MHz**
- Turn on trace : **Ch1**
- Display setup : **Standard, Persistence off, Dot join on, Single grid**
- Input Coupling : **DC 50 Ω**
- V/div. offset : **Normal**
- Global BWL : **Off**
- Probe atten : **X1**
- Input gain : **.5 V/div.**
- Trigger setup : **Smart**
- Setup Smart Trigger : **Glitch**
- Trigger on : **1**
- Coupling 1 : **DC**
- Trigger Level : **0.0 V**
- At end of : **Neg**
- Width : **< 10 nsec**
- Mode : **Norm**
- Timebase : **5 nsec/div.**

- Adjust the generator output amplitude to get a five division amplitude sine wave.

- Check that the scope triggers

- Switch to Width : **> 10 nsec**

- Check that the scope **doesn't trigger** : slow trigger and no flashes in box next to normal.

5.11.2 Trigger on Pulse Width > 10 nsec

- Adjust the generator frequency to **40 MHz**

- Check that the scope triggers

- Switch to Width : **< 10 nsec**

- Check that the scope **doesn't trigger** : slow trigger and no flashes in box next to normal.

8-Aug-94
16:38:01

5 ns
0.50 V
-5 mV

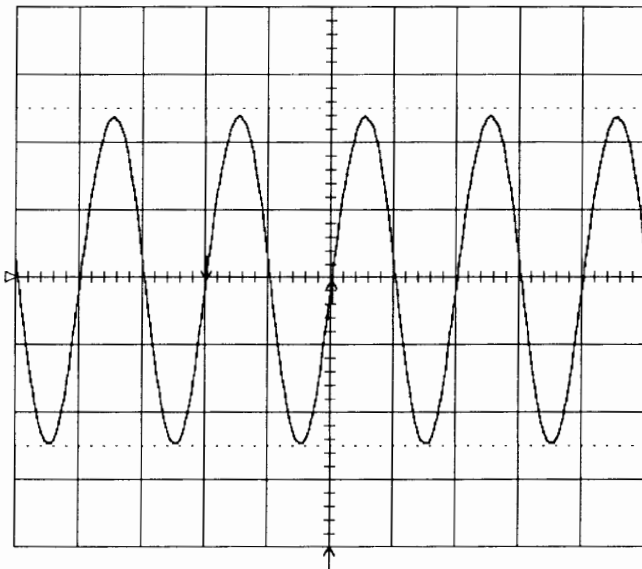

- 5 ns RIS
- 1 .5 V 50Ω
 - 2 .5 V 50Ω
 - 3 .5 V 50Ω
 - 4 .5 V 50Ω

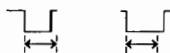

Δt 10.000 ns $\frac{1}{\Delta t}$ 100.00 MHz

1 DC 0.00 V
pulse < 10.0 ns

TRIGGER SETUP

Edge **SMART**
(GLITCH)

SETUP SMART TRIGGER

trigger on
1 2 3 4
Ext Ext10

coupling 1
DC AC
LFREJ HFREJ

at end of
Neg Pos
pulse

width <
10.0 ns
OFF On

width >
- - -
OFF On

NORMAL
10 Gs/s

8-Aug-94
16:39:03

5 ns
0.50 V
10 mV

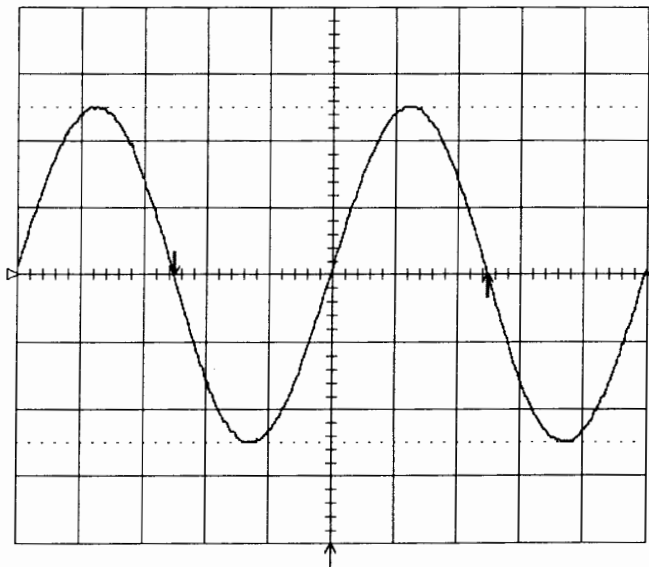

- 5 ns RIS
- 1 .5 V 50Ω
 - 2 .5 V 50Ω
 - 3 .5 V 50Ω
 - 4 .5 V 50Ω

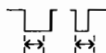

Δt 25.000 ns $\frac{1}{\Delta t}$ 40.000 MHz

1 DC 0.00 V
10.0 ns < pulse

TRIGGER SETUP

Edge **SMART**
(GLITCH)

SETUP SMART TRIGGER

trigger on
1 2 3 4
Ext Ext10

coupling 1
DC AC
LFREJ HFREJ

at end of
Neg Pos
pulse

width <
- - -
OFF On

width >
10.0 ns
OFF On

NORMAL
10 Gs/s

5.11.3 Trigger on Pulse Width < 100 nsec

- Set the generator frequency to **10 MHz**
- Pulse width : **< 100 nsec**
- Timebase : **20 nsec/div.**
- Check that the scope triggers.

8-Aug-94
16:40:30

1
20 ns
0.50 V
0 mV

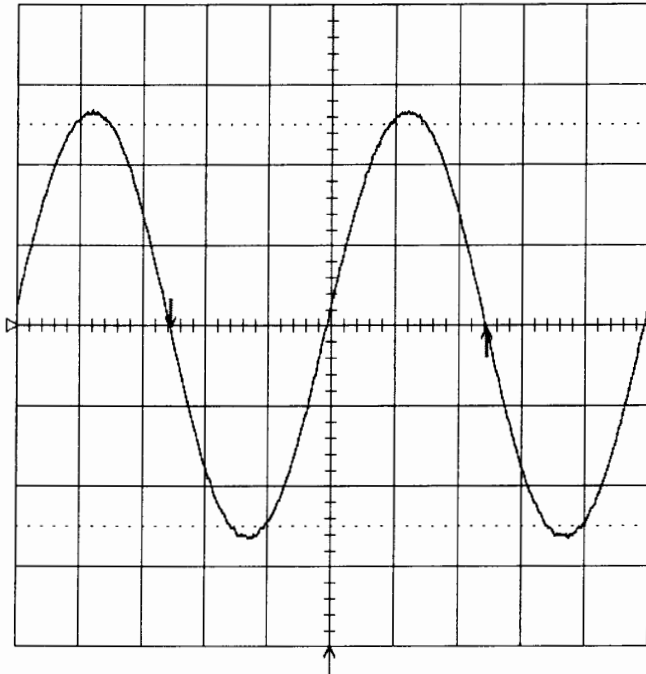

TRIGGER SETUP

Edge **SMART**
(GLITCH)

SETUP SMART TRIGGER

trigger on
1 2 3 4
Ext Ext10

coupling 1
DC AC
LFREJ HFREJ

at end of
Neg Pos
pulse

width <
100.0 ns
OFF **On**

width >
- - -
OFF On

20 ns RIS

- 1 .5 V 50Ω
- 2 .5 V 50Ω
- 3 .5 V 50Ω
- 4 .5 V 50Ω



Δt 100.0 ns 1/Δt 10.00 MHz

1 DC 0.00 V
pulse < 100.0 ns

NORMAL
10 Gs/s

- Switch to Width : **> 100 nsec**
- Check that the scope **doesn't trigger** : slow trigger and no flashes in box next to normal.

5.11.4 Trigger on Pulse Width > 100 nsec

- Adjust the generator frequency to **4 MHz**
- Pulse width : **> 100 nsec**
- Set Timebase : **50 nsec/div.**
- Check that the scope triggers.

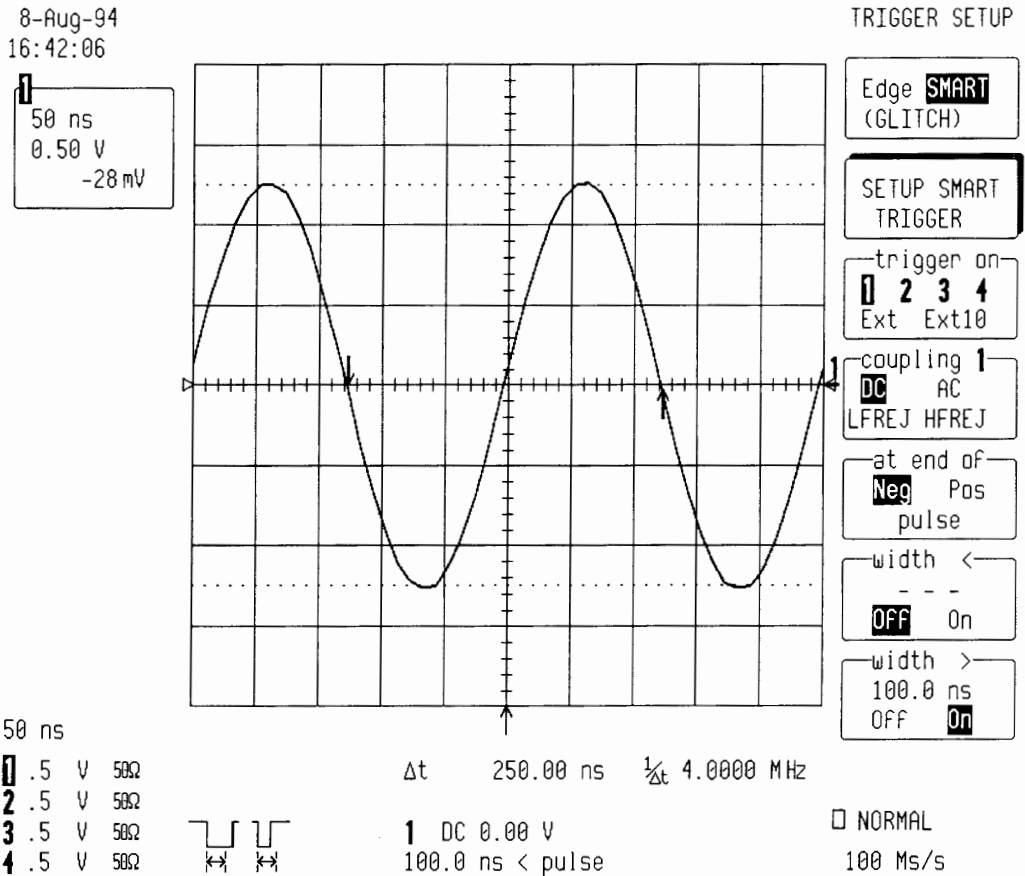

- Switch to Width : **< 100 nsec**
- Check that the scope **doesn't trigger** : slow trigger and no flashes in box next to normal.
- Repeat all the above tests for Channel 2, Channel 3 and Channel 4 substituting channel control and input connector, and check as above.

5.12 Time Base Accuracy

5.12.1 Description

An external sine wave generator of **1 MHz** with a frequency accuracy better than 1 ppm is used.

Specifications

100 MHz clock : accuracy : $\leq \pm 0.002 \%$ or $\leq \pm 20$ ppm

5.12.2 100 MHz Clock Manual Verification Procedure

Setup a leveled sine wave generator.

- Frequency : **1 MHz**
- Connect the generator output to Channel 1
- Turn on trace : **Ch1**
- Display setup : **Standard, Persistence off, Dot join on, Single grid**
- Input Coupling : **DC 50 Ω**
- V/div. offset : **Normal**
- Probe atten : **X1**
- Input gain : **.5 V/div.**
- Trigger setup : **Edge**
- Trigger on : **1**
- Coupling 1 : **DC**
- Slope 1 : **Pos**
- Level 1 : **0.5 V**
- Mode : **Norm**
- Holdoff : **Off**
- Delay : **0 %**
- Timebase : **.2 μ sec/div.**
- Sampling : **Ris**
- Record up to : **50 K**

- Adjust the generator output amplitude and Ch1 offset to get a five divisions peak to peak amplitude sine wave.
- Store Channel 1 in Memory 1
- Set Post-trigger delay to **2.00 msec**

This allows the accuracy of the time base clock to be checked **2000 periods** after the trigger point.

10-Aug-94
10:37:50

STORE W'FORMS

0
.2 μ s
0.50 V
-16 mV

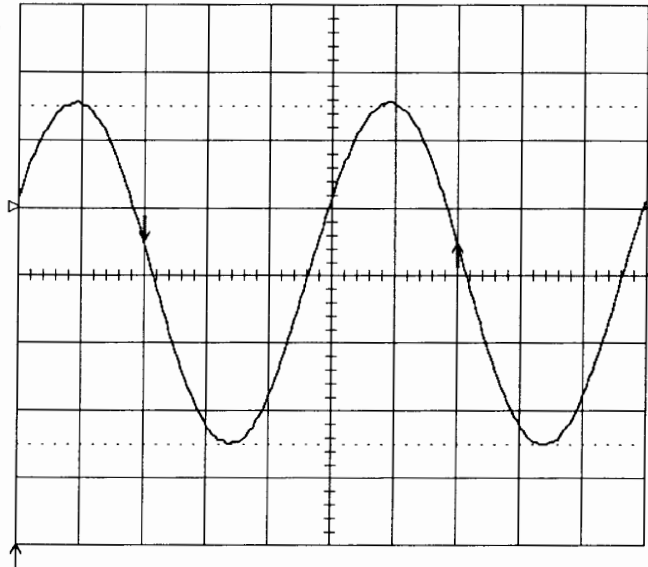

DO STORE (1-M1)

store

0	2
3	4
A	B
C	D

to

M1 M2 M3 M4

- 0 .2 μ s
- 1 .5 V 50 Ω
- 2 .5 V 50 Ω
- 3 .5 V 50 Ω
- 4 .5 V 50 Ω

Δt 1.000 μ s $\frac{1}{\Delta t}$ 1.000 MHz

1 DC 0.50 v

NORMAL
100 Ms/s

10-Aug-94
10:38:16

STATUS

ACQUISITION STATUS

	0	2	3	4
Vertical				
V/div	.5 V	.5 V	.5 V	.5 V
Probe	x1	x1	x1	x1
Offset	15 mV	-240 mV	-285 mV	-275 mV
Coupling	DC50 Ω	DC50 Ω	DC50 Ω	DC50 Ω

Acquisition

System
Text & Times
Waveform

Bandwidth Limit OFF

Time base
Time/div .2 μ s Time/pnt 10 ns (100 Ms/s)
RIS OFF
Sequence OFF Pts/div 20

Trigger Edge Mode NORMAL
External Attenuation x1

1 DC 0.50 V

Post-trigger Delay 2.00000 ms

The currently preselected Smart Trigger type is
GLITCH

NORMAL
100 Ms/s

Section 5 Performance Verification

- Recall Memory 1 to A
- Turn on trace A
- Check that the displayed Channel 1 trace is **aligned** with the sine wave from memory 1.
- Press : **Cursors/Measure**
- Measure : **Parameters**
- Mode : **Custom**
- Statistics : **Off**
- Change parameters
- On line 1 : **Delay of 1**
- On line 2 : **Delay of A**
- Check that $(\text{delay}(A) - \text{delay}(1) + 2 \text{ msec}) \leq \pm 0.00004 \text{ msec}$ (4.00 EE-08) corresponding to **20ppm**.

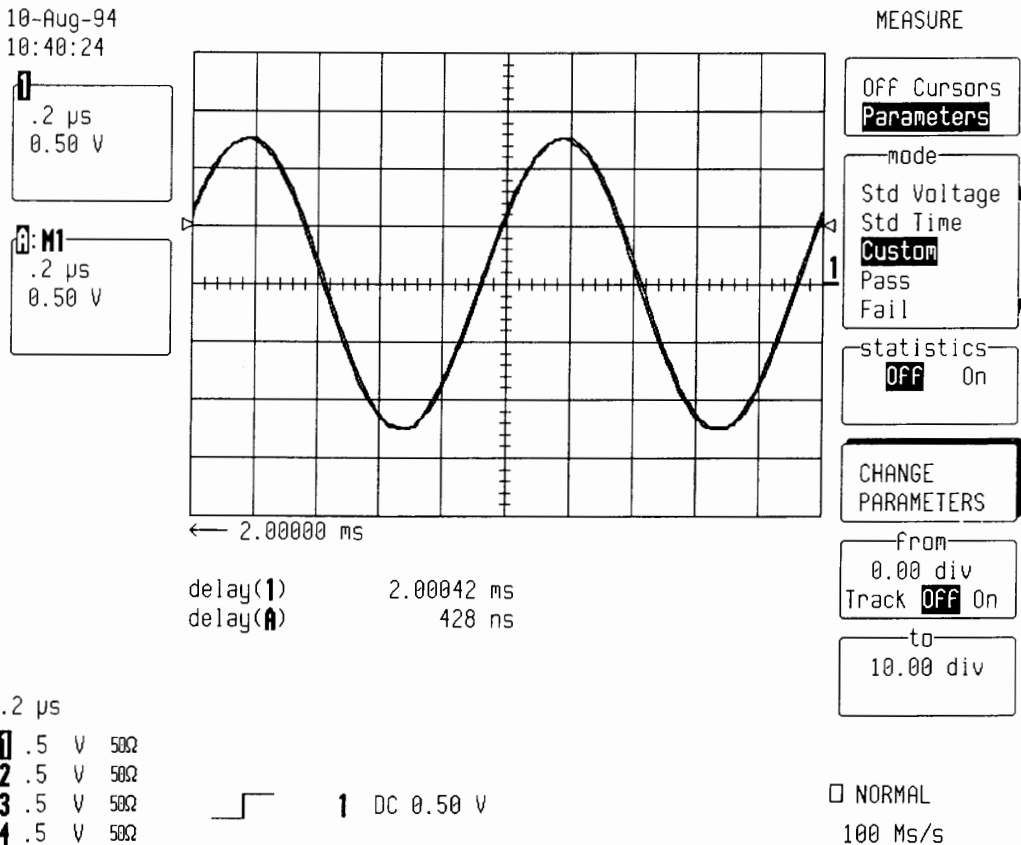

A difference of $\pm 0.04 \mu\text{sec}$ corresponds to $\pm 20 \text{ ppm}$.

See screen dump below :

10-Aug-94
10:41:39

MEASURE

1
.2 μs
0.50 V

OFF Cursors
Parameters

M1
.2 μs
0.50 V

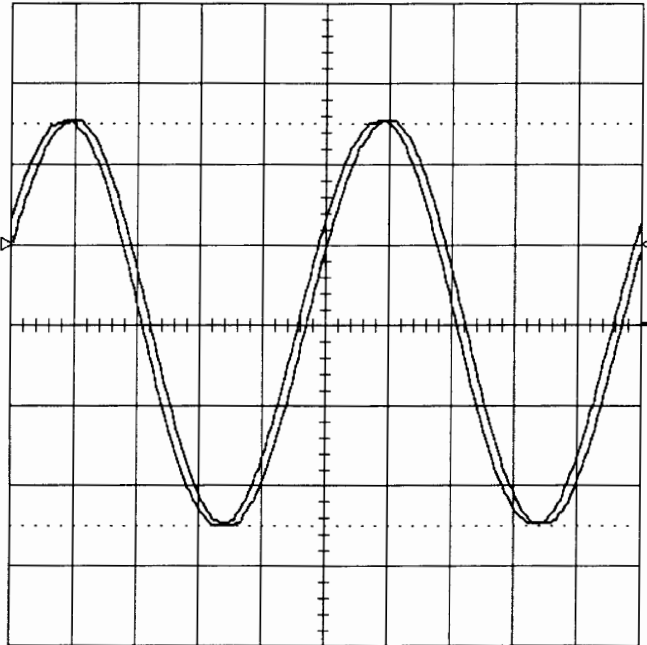

.2 μs
1 .5 V 50 Ω
2 .5 V 50 Ω
3 .5 V 50 Ω
4 .5 V 50 Ω

← 2.00000 ms



1 DC 0.50 V

NORMAL
100 Ms/s

5.13 Rise time (10%-90%) and Overshoot

Specifications

DC 50 Ω , 100 mV/div., : Rise \leq 1.1 ns

DC 50 Ω , 100 mV/div., : Overshoot \leq 5.5 %

Procedure

- Apply the fast pulse generator LeCroy 4969 (< 500 psec) or equivalent, to Channel 1

- Set the DSO as follows :

- Display setup : **Standard, Persistence off, Dot join on, Single grid**
- Input Coupling : **DC 50 Ω**
- V/div. offset : **Normal**
- Global BWL : **Off**
- Probe atten : **X1**
- Input offset : **- 250 mV**
- Input gain : **100 mV/div.**
- Trigger setup : **Edge**
- Trigger on : **1**
- Trigger level : **DC 250 mV**
- Coupling 1 : **DC**
- Slope 1 : **Pos**
- Mode : **Normal**
- Holdoff : **Off**
- Timebase : **2 nsec/div.**
- Record up to : **50 K**
- Delay : **30 % Pre-Trigger**

- Cursors/Measure : **Parameters**
- Mode : **Custom**
- Statistics : **On**
- Change Parameters :
- On line 1 : **Rise(1)**
- On line 2 : **Overshoot(1)**

- After at least 100 sweeps :

check that the Average rise time is \leq **1.1 ns** (measured in scope and not corrected for the effect of the step generator).

check that the Average overshoot is \leq **5.5 %** (measured in scope and not corrected for the effect of the step generator).

- Repeat the above tests for Channel 2, Channel 3 and Channel 4 substituting Channel control and input connector, and check as above.

9-Aug-94
9:25:33

2 ns
100 mV

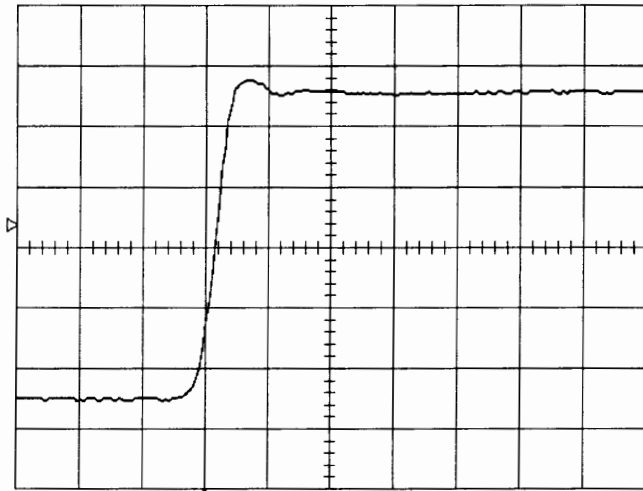

	87 sweeps:	average	low	high	sigma
rise(1)		0.93 ns	0.87	0.97	0.02
over+(1)		4.2 %	3.5	4.7	0.3

CHANGE PARAM

On line
 2 3 4 5

DELETE ALL
PARAMETERS

measure
pkpk
points
 rise
r20-80%
r@level

of
 2 3 4
A B C D

2 ns RIS

- .1 V 50Ω
- .1 V 50Ω
- .1 V 50Ω
- .1 V 50Ω

1 DC 288 mV

NORMAL
10 Gs/s

5.14 Probe Calibrator Verification

Specifications

Amplitude : 50 mV to 500 mV $\pm 2\%$ into 50Ω
: 50 mV to 1 V $\pm 2\%$ into 1 MΩ

Frequency : 500 Hz to 2 MHz $\pm 1\%$

Probe Calibrator Verification Procedure

- Connect the Probe Calibrator output to Channel 1, using a 5 nsec BNC cable
- Select : **Utilities**
- Press : **Cal BNC Setup**
- Mode : **Cal signal**
- Set Frequency : **500 Hz**
- Amplitude : **1 V (500 mV into 50 Ω)**

- Turn on trace : **Ch1**
- Display setup : **Standard, Persistence off, Dot join on, Single grid**
- Input Coupling : **DC 50 Ω**
- V/div. offset : **Normal**
- Probe atten : **X1**
- Input offset : **- 250 mV**
- Input gain : **100 mV/div.**

- Trigger setup : **Edge**
- Trigger on : **1**
- Trigger level : **DC 250 mV**
- Coupling 1 : **DC**
- Slope 1 : **Pos**
- Mode : **Normal**
- Holdoff : **Off**

- Timebase : **.5 msec/div.**
- Delay : **10 % Pre-Trigger**

- Cursors/Measure : **Parameters**
- Mode : **Custom**
- Change parameters :
- On line 1 : **Measure ampl of 1**
- On line 2 : **Measure freq of 1**

- Check parameters readout : freq (1) = **500 Hz \pm 1 %** , and ampl (1) = **500 mV \pm 6 %**
 (\pm 2 % plus \pm 4 % due to the non linearity of the scope)

- Set Cal frequency : **2 MHz**
- Timebase : **.2 μ s**

- Check that freq (1) is **2 MHz \pm 1 %**

- Repeat test for amplitude of **0.05 V (25 mV into 50 Ω)**

- Set Cal amplitude : **50 mV (25 mV into 50 Ω)**
- DSO Input gain : **5 mV/div.**

- Check parameters readout ampl (1) = **25 mV \pm 6 %**

9-Aug-94
11:00:05

1
.5 ms
100 mV

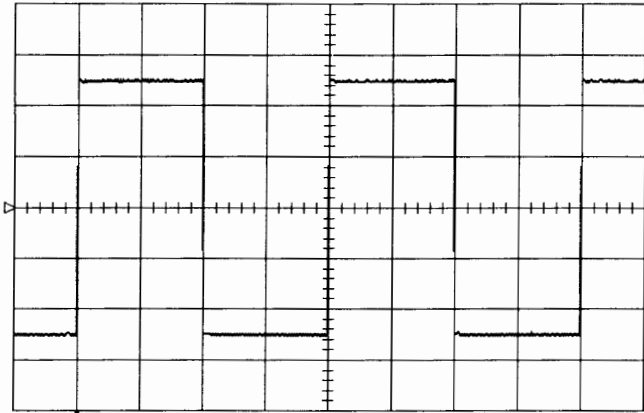

481 sweeps: average low high sigma
 ampl(1) 500mV 498 500 1
 Freq(1) 500.000 Hz 499.988 500.003 0.001

CAL BNC OUT
mode
CAL signal
OFF
Pass/Fail
Trigger Out

SET TO 1 KHz
1 V SQUARE

Shape
Square
Pulse(25 ns)

Amplitude
1.00 V
into 1 MΩ

Frequency
500 Hz

.5 ms

- 1 .1 V 50Ω
- 2 .1 V 50Ω
- 3 .1 V 50Ω
- 4 .1 V 50Ω

1 DC 250 mV

NORMAL
10 Ms/s

9-Aug-94
11:01:06

1
.2 μs
100 mV

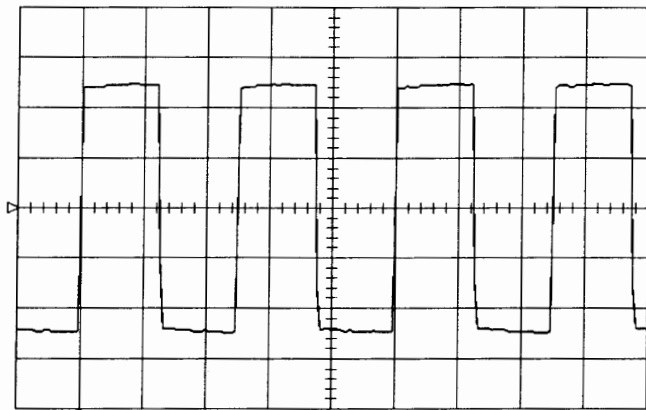

258 sweeps: average low high sigma
 ampl(1) 490mV 488 492 1
 Freq(1) 2.00 MHz 2.00 2.01 0.00

CAL BNC OUT
mode
CAL signal
OFF
Pass/Fail
Trigger Out

SET TO 1 KHz
1 V SQUARE

Shape
Square
Pulse(25 ns)

Amplitude
1.00 V
into 1 MΩ

Frequency
2 MHz

.2 μs

- 1 .1 V 50Ω
- 2 .1 V 50Ω
- 3 .1 V 50Ω
- 4 .1 V 50Ω

1 DC 250 mV

NORMAL
100 Ms/s

Section 5 Performance Verification

- Repeat the tests for the amplitude of 0.05 V and 1 V into 1 MΩ
- Cal amplitude : **50 mV**
- Set Input Coupling : **DC 1M Ω**
- DSO Input gain : **10 mV/div.**
- Check parameters readout ampl (1) = **50 mV ± 6 %**

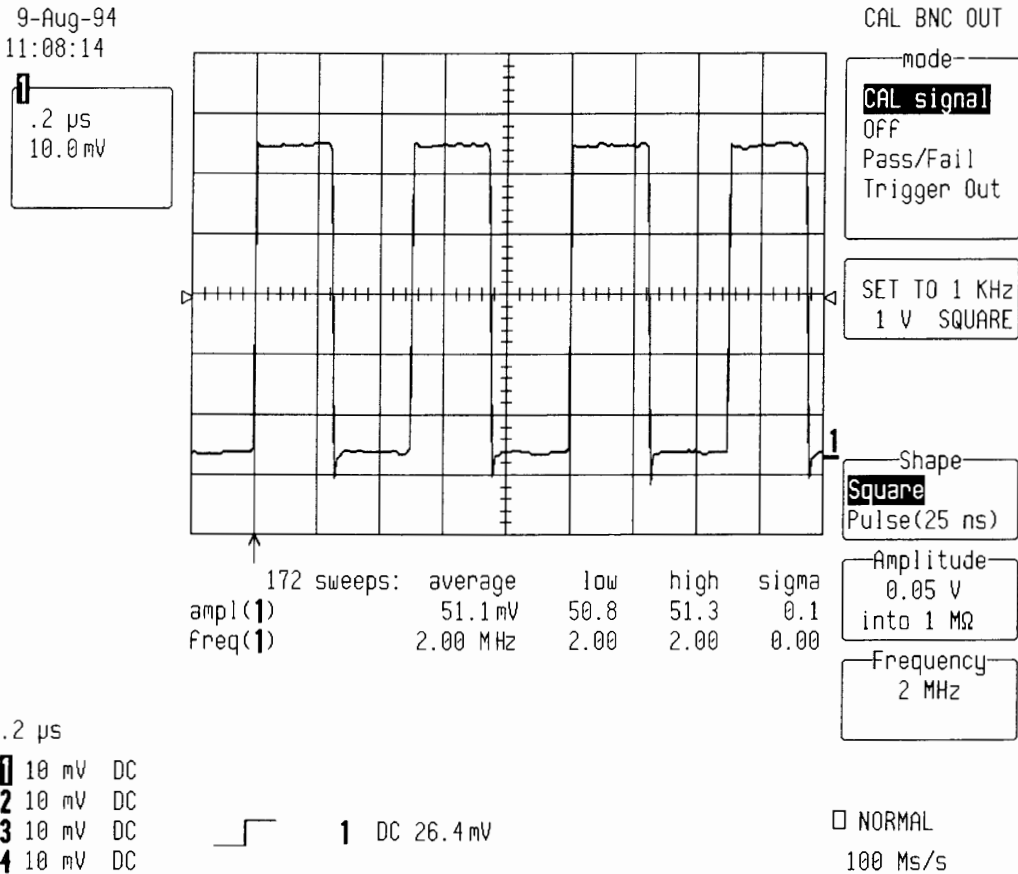

- Set Cal amplitude : **1 V**
- DSO Input gain : **200 mV/div.**
- Check parameters readout ampl (1) = **1 V ± 6 %**

5.15 Overload

Specifications

1 Watt into 50 Ω : Overload < 17 seconds

Procedure

- Set the DSO as follows :
 - Display setup : **Standard, Persistence off, Dot join on, Single grid**
 - Input Coupling : **DC 50 Ω**
 - V/div. offset : **Normal**
 - Global BWL : **Off**
 - Probe atten : **X1**
 - Input offset : **- 3.5 V**
 - Input gain : **1 V/div.**
 - Trigger setup : **Edge**
 - Trigger on : **1**
 - Trigger level : **DC - 0.04 V**
 - Delay : **zero**
 - Coupling 1 : **DC**
 - Slope 1 : **Pos**
 - Mode : **Auto**
 - Holdoff : **Off**
 - Timebase : **2 sec/div.**
 - Record up to : **2500 samples**
- From Tektronix power supply PS5004, apply **7.07 V** (1 Watt) to Channel 1.
- Check that the overload trips, within **17** seconds.
- Set Timebase : **5 sec/div.**
- From Tektronix power supply PS5004, apply **5 V** (.5 Watt) to Channel 1
- Check that the overload doesn't trip for at least **30** seconds.
- Repeat the above tests for Channel 2, Channel 3 and Channel 4 substituting channel control and input connector, and check as above.

Section 5 Performance Verification

9-Aug-94
11:13:18

2 s
1.00 V
-31 mV

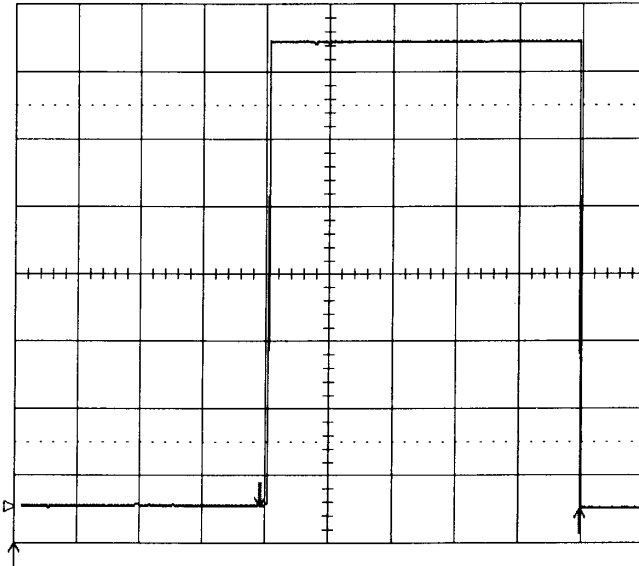

CHANNEL 1

Coupling
DC50Ω
OVERLOAD
DC1MΩ
Grounded
AC1MΩ

V/div Offset
NORMAL
ECL TTL

Global BWL
OFF On
(30 MHz)

Probe Atten
x1
x2
x5
x10
x20

2 s

- 1 1 V $\frac{1}{2}$
- 2 1 V 50Ω
- 3 1 V 50Ω
- 4 1 V 50Ω

Δt 10.13 s $\frac{1}{\Delta t}$ 98.72 mHz



1 DC 0.04 V

STOPPED
100 s/s

9-Aug-94
11:38:17

5 s
1.00 V

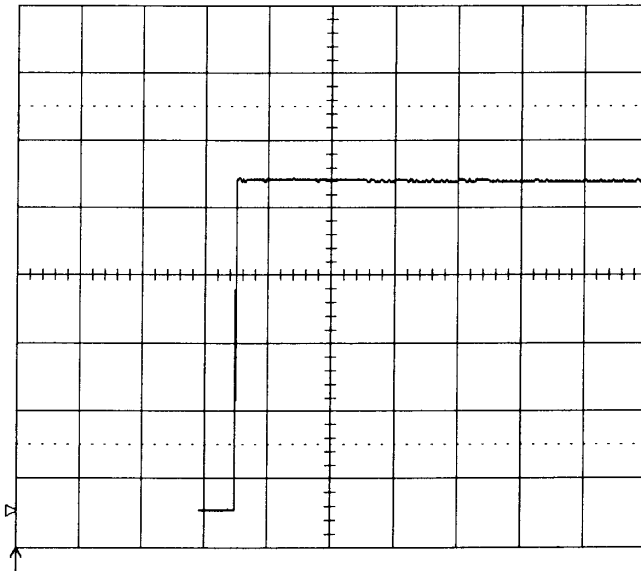

CHANNEL 1

Coupling
DC50Ω
Grounded
DC1MΩ
Grounded
AC1MΩ

V/div Offset
NORMAL
ECL TTL

Global BWL
OFF On
(30 MHz)

Probe Atten
x1
x2
x5
x10
x20

5 s

- 1 1 V 50Ω
- 2 1 V 50Ω
- 3 1 V 50Ω
- 4 1 V 50Ω



1 DC 0.04 V

STOPPED
50 s/s

SECTION 6 INTERNAL CALIBRATION and DIAGNOSTICS

6.1 Introduction

- The 9314A/M/L internal calibration use routines to confirm basic functionality, no test equipment is required to do these test procedures. The **diagnostics menu** is entered by simultaneously depressing the **third and fourth** menu push buttons on the right hand side of the CRT and then by depressing the **fifth**.
- To quickly check the performance of the digital storage oscilloscope, select the **calibration diagnostics**.
- Press the **recalibrate completely** button to do a full recalibration of the front end. It is advisable to perform this type of check when the scope is in a stable condition.

9-Aug-94
11:39:22

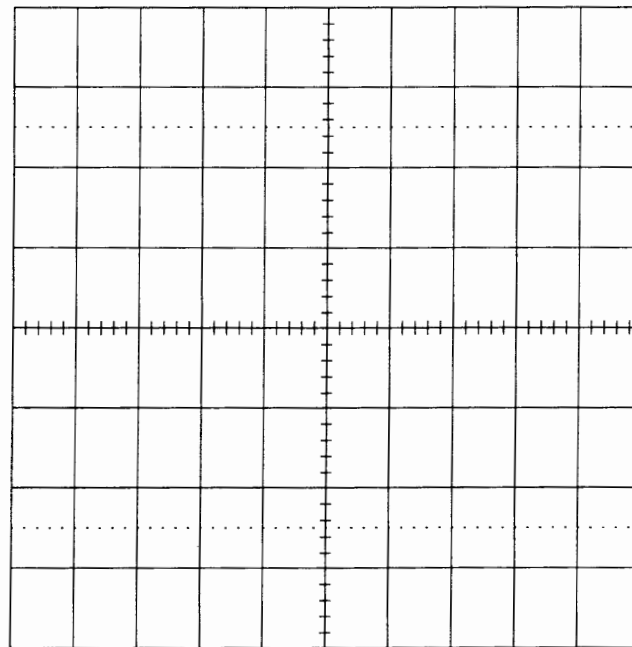

INTERNAL

- Calibration Diagnostics
- Maintenance
- Development

10 μ s

- 0 1 V 50 Ω
- 2 1 V 50 Ω
- 3 1 V 50 Ω
- 4 1 V 50 Ω



1 DC 0.00 V

AUTO
25 Ms/s

6.2 Diagnostic Summary

- Press **diagnostic summary**.
- This is a handy tool to perform a quick but comprehensive **internal performance** check, without touching the acquisition settings. The failures are indicated by channel identifiers.
- If no problem is detected, the fields are left **blank**.

```

9-Aug-94
11:39:40
31°
          Calibration Diagnostic Summary          10.0 ns
Gain and Offset Calibration:
          2 mV  5 mV  10 mV  20 mV  50 mV  .1 V
ADC zero reading
gain measurement
gain is negative
gain control range
offset control range
final gain setting
final offset setting
Trigger Level Calibration:
          Trigger          Validate
          dc  bwl  hFr    ac    dc  bwl  hFr  ac
control
hysteresis
Trigger Interval Counter Calibration:  2.524 [ns]  passed
    
```

CALIBRATION

Diagnostic Summary

Diagnostic Results

Diagnostic Measurements

Recalibrate Completely

Failures are indicated by channel identifiers. Fields are left blank if no problem detected or a failure occurred previously. □

- The **gain** and **offset** calibration results displayed for Channel 1, Channel 2, Channel 3 and Channel 4 are independent of the following conditions:
 - Time base
 - 50 Ω or 1 MΩ input impedance
 - BWL on or off
 - Variable gain
 - Offset
 - Trigger mode and coupling
- The internal calibration is checked at **DC 1 MΩ**, and for the **six gain** settings : 2 mV, 5 mV, 10 mV, 20 mV, 50 mV, .1 V/div.

6.2.1 Gain and Offset Calibration Description

- ADC zero reading : Failed to get 0 reading from ADC for some choice of Vgain, and Cal signal, while varying the Offset
- Gain measurement : Failed to measure Gain, the gain was not what was expected.
- Gain is negative : Measured a negative Gain or broken channel.
- Gain control range : The range of the variable Gain is checked.
- Offset control range : The range of the variable Offset is checked.
- Final gain setting : An error is detected if the variable Gain and fix Gain adjustment do not converge to the desired Gain.
- Final offset setting : An error is detected if the 3 Offset calibration points do not lie on a straight line.

6.2.2 Trigger Level Calibration

- The control of the trigger hysteresis is done in the trigger mode DC, BWL on, HFr, and AC. If an error has occurred 1, 2, 3, 4 or E is displayed corresponding to Channel 1, Channel 2, Channel 3, Channel 4 or External.
- Control : Failed if no transition of discriminator observed when stepping the Threshold level.
- Hysteresis : Failed to get correct Hysteresis.

6.3 Diagnostic Results

6.3.1 Gain Curves

- Press **diagnostic results**
- Select results for **gain**
- Press **recalibrate completely**
- Select show results for **Channel 1**
- Variable gain range, checked by software must be better than 0.95 to at least 2.75. With regards to the illustration, the lower portion of the curve must extend below **0.95** limit, and the upper portion above the **2.75** limit.
- If this is not true the Gain control range summary shows a violation for Channel 1.
- The maximum and minimum gain factors are displayed.

Section 6 Internal Calibration and Diagnostics

9-Aug-94
11:40:03
31°

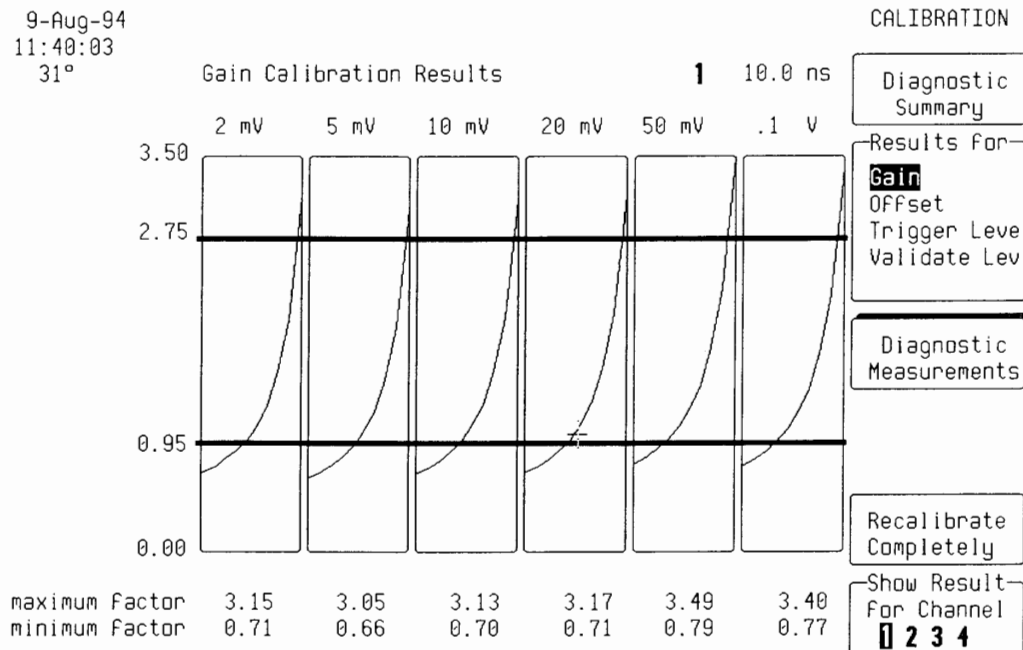

Monitor: rc 2; 1: Δg 1165, Δo 0

- Repeat the test for Channel 2, Channel 3 and Channel 4.

6.3.2 Offset Curves

- Select results for **Offset**, and show result for **Channel 1**

X = offset DAC range

Y = offset

- The curves should be above the positive limits $+0.12\text{ V} / +1.2\text{ V}$ and below the negative limits $-0.12\text{ V} / -1.2\text{ V}$.
- For the sensitivities 2 mV, 5 mV/div. a 1/10 attenuator is used, the limits are $\pm 0.12\text{ V}$.
- For the sensitivities 10 mV, 20 mV, 50 mV, 0.1 V/div. the limits are $\pm 1.2\text{ V}$.
- The maximum and minimum offset is $\pm 1.2\text{ V}$. The calibration verifies that the DAC can reach this value.
- The intrinsic value represents the offset in mV that should be applied to get zero offset to the ADC.

NB : ΔBWL is the difference between BWL on and BWL off.

9-Aug-94
11:40:18
31°

CALIBRATION

Offset Calibration Results

1 10.0 ns

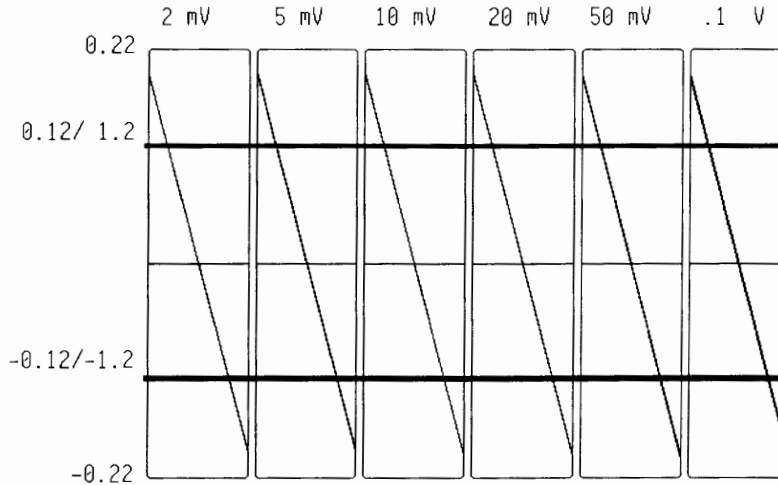

Diagnostic Summary

Results for:

- Gain
- Offset
- Trigger Level
- Validate Level

Diagnostic Measurements

Recalibrate Completely

Show Result for Channel

1 2 3 4

range high [V]	0.194	0.195	1.972	1.960	1.934	1.901
range low [V]	-0.192	-0.190	-1.966	-1.973	-1.985	-1.990
intrinsic [mV]	0.6	1.6	1.4	-3.0	-12.7	-18.8
ΔBWL [mV]	0.1	0.3	0.6	-1.2	-1.4	-2.9

Monitor: rc 3; 1: Δg 1338, Δo 0

- Repeat the test for Channel 2, Channel 3 and Channel 4.

6.3.3 Trigger Level Calibration

- Select results for **trigger level**
- For Channel 1, Channel 2, Channel 3 and Channel 4 the hysteresis value for trigger DC, BWL, HFR, AC is given in **divisions**. The trigger range is ± 5 div. for the steep curve. The boxed region is zoomed to give the two lines with a vertical scale of ± 1 div. The external trigger hysteresis is given in **Volt**. The offset of the positive curve relating trigger threshold to DAC setting is given.
- Press **recalibrate completely**
- Select show result for **Channel 1**
- The **DC** hysteresis in div. should be ± 0.3 div. ± 0.1 div.
- Repeat the test for Channel 2, Channel 3 and Channel 4.

Section 6 Internal Calibration and Diagnostics

9-Aug-94
11:40:42
31°

Trigger Level Calibration Results

1 10.0 ns

CALIBRATION

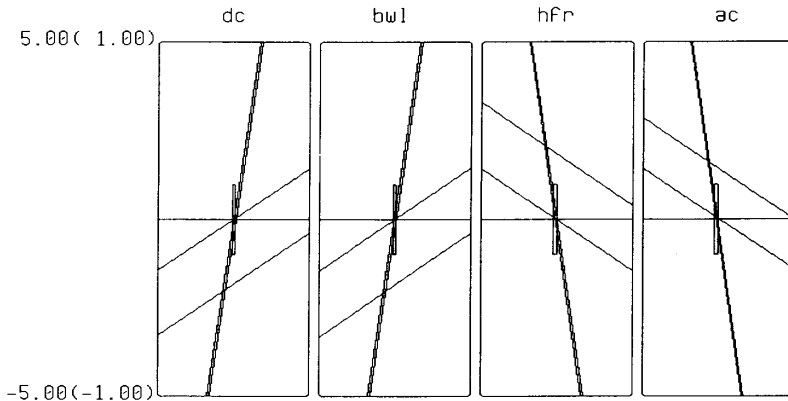

hysteresis [div]	0.366	0.372	-0.370	-0.283
offset [div]	-0.422	-0.363	0.015	-0.330

Diagnostic Summary

Results for:
Gain
Offset
Trigger Level
Validate Lev

Diagnostic Measurements

Recalibrate Completely

Show Result For Channel
1 2 3 4 E

Monitor: rc 3; 1: Δg 1338, Δo 0

- Select show result for **External trigger**
- The hysteresis in Volt should be $\pm 0.025 \text{ V} \pm 0.01$

9-Aug-94
11:41:30
31°

Trigger Level Calibration Results

E 10.0 ns

CALIBRATION

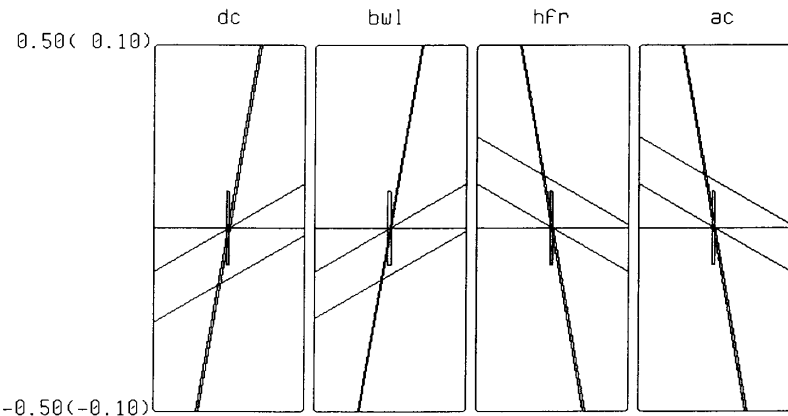

hysteresis [V]	0.028	0.026	-0.026	-0.026
offset [V]	-0.014	-0.019	0.009	0.009

Diagnostic Summary

Results for:
Gain
Offset
Trigger Level
Validate Lev

Diagnostic Measurements

Recalibrate Completely

Show Result For Channel
1 2 3 4 E

- Select results for **Validate level**
- Press **recalibrate completely**
- Select show result for **Channel 1**
- The DC hysteresis in div. should be $\pm 0.3 \text{ div.} \pm 0.1 \text{ div.}$
- Repeat the test for Channel 2, Channel 3 and Channel 4.

9-Aug-94
11:40:55
31°

Validate Level Calibration Results 1 10.0 ns

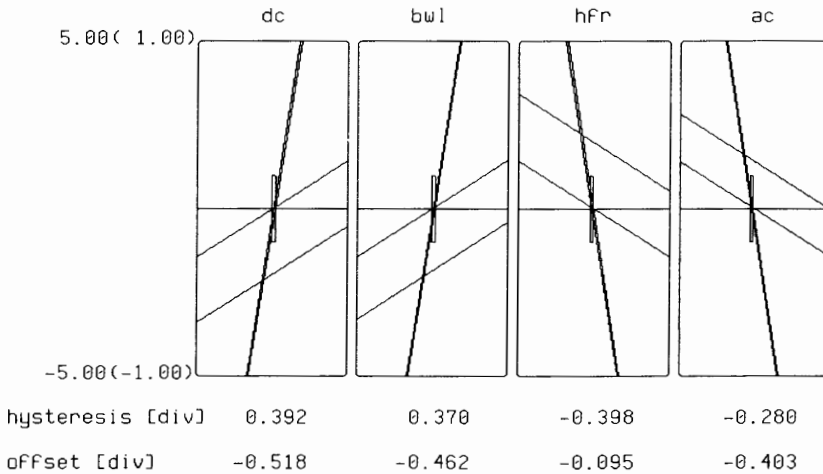

CALIBRATION

Diagnostic Summary

Results For:
Gain
Offset
Trigger Level
Validate Lev

Diagnostic Measurements

Recalibrate Completely

Show Result For Channel
1 2 3 4 E

- Select show result for **External trigger**
- The hysteresis in Volt should be $\pm 0.025 \text{ V} \pm 0.01$

9-Aug-94
11:41:49
31°

Validate Level Calibration Results E 10.0 ns

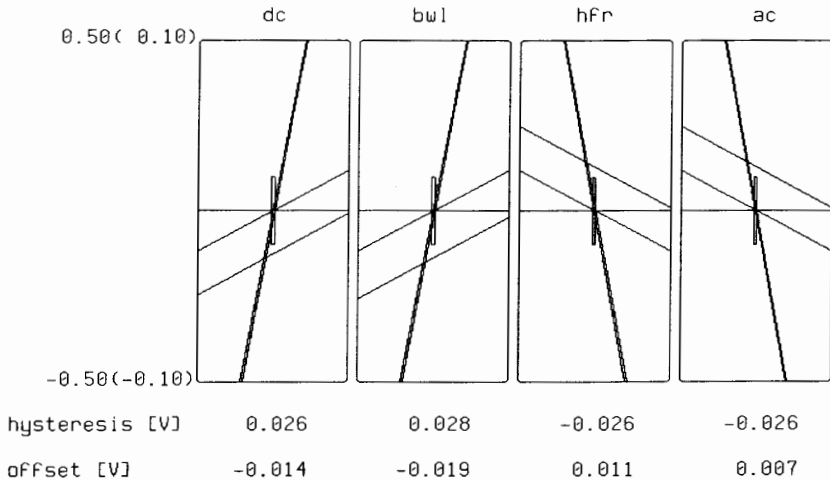

CALIBRATION

Diagnostic Summary

Results For:
Gain
Offset
Trigger Level
Validate Lev

Diagnostic Measurements

Recalibrate Completely

Show Result For Channel
1 2 3 4 E

6.3.4 Integral Linearity

- Press **diagnostic measurements**
- Select **integral linearity**
- Measure for **Channel 1**

- The integral linearity curve should be within the $\pm 0.05 * FS$ bars, for offset = 0.0 V.

9-Aug-94
11:42:29
31°

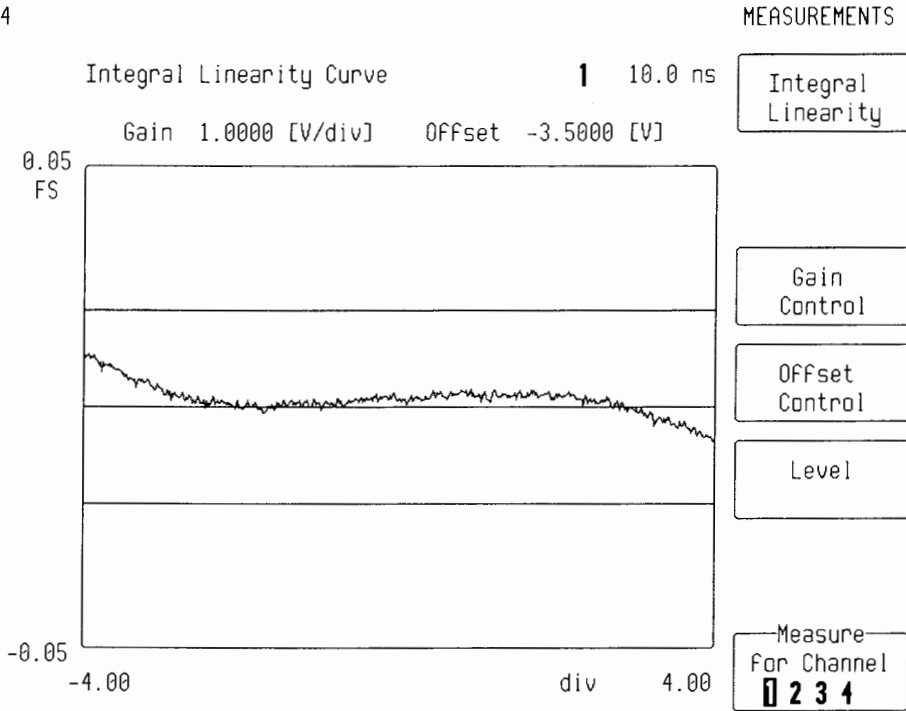

□

- Repeat the test for Channel 2, Channel 3 and Channel 4.

- Press **level**
- Measure for **Channel 1**
- The three plots show raw ADC data displayed around their mean value for 3 different CAL levels.
- The data should be **narrow** and random.

- The theoretical level is shown by the second horizontal line which should be near (< 4 steps) to the measured value for Offset = 0.

9-Aug-94
11:48:21
31°

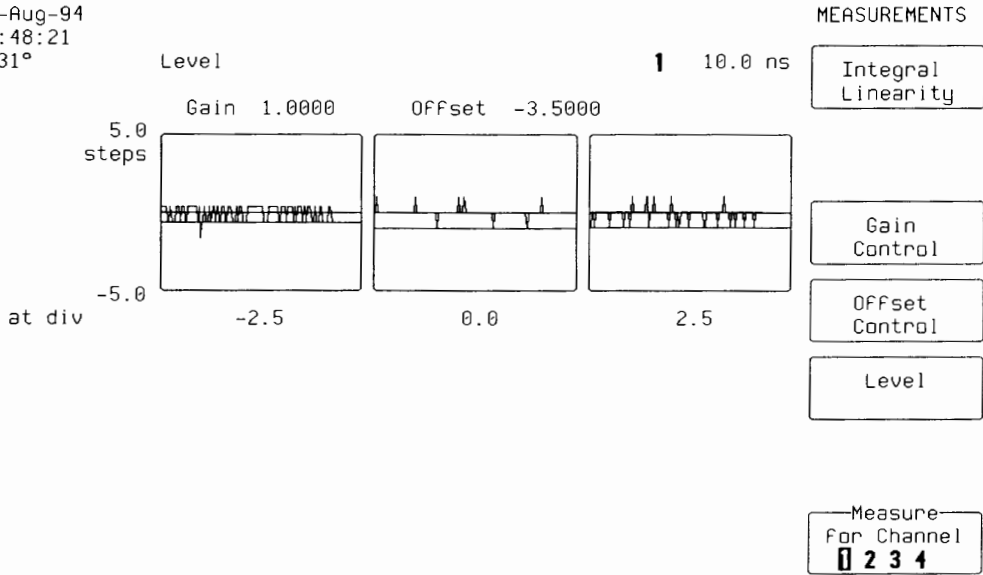

- Repeat the test for Channel 2, Channel 3 and Channel 4.

6.4 Board Test Results

- From the Internal menu press **Maintenance**
- Select **Board Test Results**

9-Aug-94
11:49:40

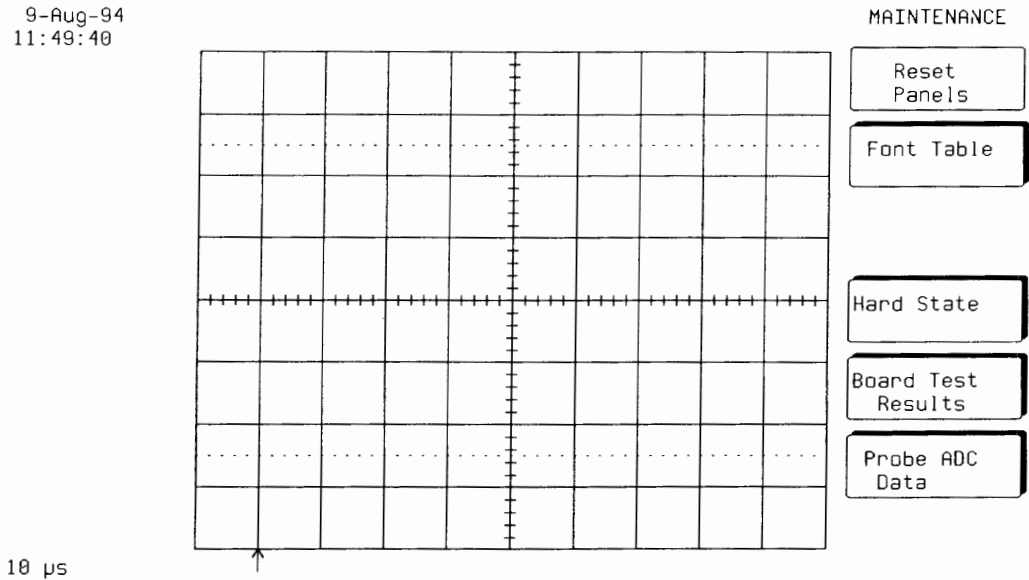

- This menu displays the board calibration measured at the factory, the calibration values are loaded in the I2C Prom.
- The header block indicates the following information :
 - The test version : i.e. 147
 - The revision of the printed circuit board : i.e. Rev B
 - The engineering change order level : i.e. ECO 1004
 - The work order number : i.e. WO 9417-0017
 - The tested date : i.e. tested 1994-06-07 it should be : $\geq 1993\text{-xx-xx}$.
- If the date says 1990-04-01 it is a sign that the I2C prom on the -3 board can not be read correctly.
- The gain, offset, level, timing, delay values shown in this menu are used to perform the internal calibration of the scope. If more extensive information of those parameters is required, see the 9314A/M/L Service Manual.

9-Aug-94
11:49:17

Board Test

Header: block lengths 20 32 0 Test version 147 4 chans
Rev: B, ECO 1004, WO 9417-0017, Tested: 1994-06-07 8:45

CAL levels: (E66A, -2000mV) (7FFF, 0mV) (1996, 2000mV)

EXT trigger: pos. (ADC0, -413mV) (5530, 414mV)

neg. (AAC0, -413mV) (5230, 414mV)

EXT/10 attenuator: 10.045

Delay correction: 20.00 ns

6.5 Probe Bus Verification

- From the Internal menu press **Maintenance**
- Select **probe ADC data**
- This menu displays the probe bus and probe ring status.
- With no probe connected to the input, check that the value in the first column is 251 ± 2 for Channel A, B, C, D, and Ext.

9-Aug-94
11:50:30

Probe Data

	value	limits	interrupts	
Channel A	252	252 [245,255]	0	
Channel B	252	252 [245,255]	0	
Channel C	252	252 [245,255]	0	
Channel D	252	252 [245,255]	0	
Channel EXT	252	252 [245,255]	0	
Channel CAL	252	252 [0,255]	0	
Channel MON	125	125 [73, 79]	0	
Channel T	101	101 [95,107]	4	Temperature 31°C

- Connect a **AP020 or AP021** LeCroy active probe to Channel 1 and check that:
 - The probe is identified on physical **Channel A**
 - The Channel A value indicates in the first column has changed to **21 ± 2**
 - An **interrupt** has been detected on Channel A

9-Aug-94
11:51:13

Probe Data

	value	limits	interrupts	
Channel A	21	21 [6, 26]	1	AP021
	01 08 00 41 50 30 32 31 04 06		93 23 00 16 11 06 40 a0 00 00	
	15 06 3d cc cc cd 21 0a 40 04		b6 43 38 84 bf 26 22 0b c0 00	
	00 00 40 00 00 00 01 24 07 01		46 42 01 00 34 06 00 10 00 42	
	36 04 02 04 41 06 32 04 48 f5		3a	
Channel B	252	252 [245,255]	0	
Channel C	252	252 [245,255]	0	
Channel D	252	252 [245,255]	0	
Channel EXT	252	252 [245,255]	0	
Channel CAL	252	252 [0,255]	0	
Channel MON	125	125 [73, 79]	0	
Channel T	101	101 [95,107]	4	Temperature 31°C

- Connect a LeCroy passive probe with probe ring i.e. **PP002** to Channel 1 and check that :
 - The probe **X10** is identified on physical Channel A
 - The Channel A value indicates in the first column has changed to **195 ± 2**
 - An **interrupt** has been detected on A

Section 6 Internal Calibration and Diagnostics

9-Aug-94
11:53:15

Probe Data

	value	limits	interrupts	
Channel A	195	195 [173,204]	1	x10
Channel B	252	252 [245,255]	0	
Channel C	252	252 [245,255]	0	
Channel D	252	252 [245,255]	0	
Channel EXT	252	252 [245,255]	0	
Channel CAL	252	252 [0,255]	0	
Channel MON	125	125 [73, 79]	0	
Channel T	101	95 [89,101]	8	Temperature 29°C

- Repeat the tests for Channel 2, Channel 3 and Channel 4 and External Trigger.
- Check that the probe is identified on physical Channel B, C, D or Ext.

9-Aug-94
11:53:51

Probe Data

	value	limits	interrupts	
Channel A	251	252 [242,255]	4	
Channel B	252	252 [245,255]	0	
Channel C	252	252 [245,255]	0	
Channel D	252	252 [245,255]	0	
Channel EXT	21	21 [6, 26]	1	AP021
	01 08 00 41 50 30 32 31 04 06		93 23 00 16 11 06 40 a0 00 00	
	15 06 3d cc cc cd 21 0a 40 04		b6 43 38 84 bf 26 22 0b c0 00	
	00 00 40 00 00 00 01 24 07 01		46 42 01 00 34 06 00 10 00 42	
	36 04 02 04 41 06 32 04 48 f5		ff	
Channel CAL	252	252 [0,255]	0	
Channel MON	125	125 [73, 79]	0	
Channel T	101	95 [89,101]	8	Temperature 29°C

SECTION 7 MAINTENANCE**7.1 Introduction**

This section contains information necessary to disassemble, assemble, maintain, calibrate and troubleshoot the LeCroy 9314A, 9314AM, and 9314AL oscilloscope.

7.2 Disassembly and Assembly Procedure

The disassembly and assembly procedures detailed below refer to the assembly and disassembly diagram 7.2.3, and the view of figures 7.1, 7.2, 7.3, 7.4, 7.5, 7.6, 7.7. Please study the diagram and figures before attempting disassembly.

WARNING

Before removing any parts from the LeCroy 9314A/M/L, be sure to read carefully the instructions referring to those parts, noting any precautions needed to avoid problems caused by mechanical behavior, high voltage supplies, etc.

CAUTION

The usual precautions against static electricity are required, (see 1.10)

7.2.1 Removal of the Upper Cover (5.10)

The top cover (5.10) is secured by two M4x5 screws (5.12) on both sides of the front panel assembly (2), and by two M4x8 screws (5.11) on the rear panel (3). Remove the screws and carefully slide the cover off the unit to the rear. Removal of the top cover gives access to the boards and parts listed in section 7.2.3.

7.2.2 Removal of the 93XX-PS1715 Power Supply (4)**WARNING**

Ensure the line cord is disconnected. Remove the following:

- Top cover (7.2.1).
- One M4X8 screw (5.2) from left side of the bottom cover (1.1).
- Two M4X8 screws (5.1) from left side of the rear panel (3).

Disconnect the following:

- Base card power cable (5.9), from base board connector J2.
- Line input cable from line input module (3.7).

The power supply can now be removed vertically from the oscilloscope.

7.2.3 Disassembly and Assembly Diagram

Disassembly : If it becomes necessary to replace a board or a part, use the disassembly diagram to disassemble the unit. Any board can be removed if items higher in the diagram and connected by a line are already out.

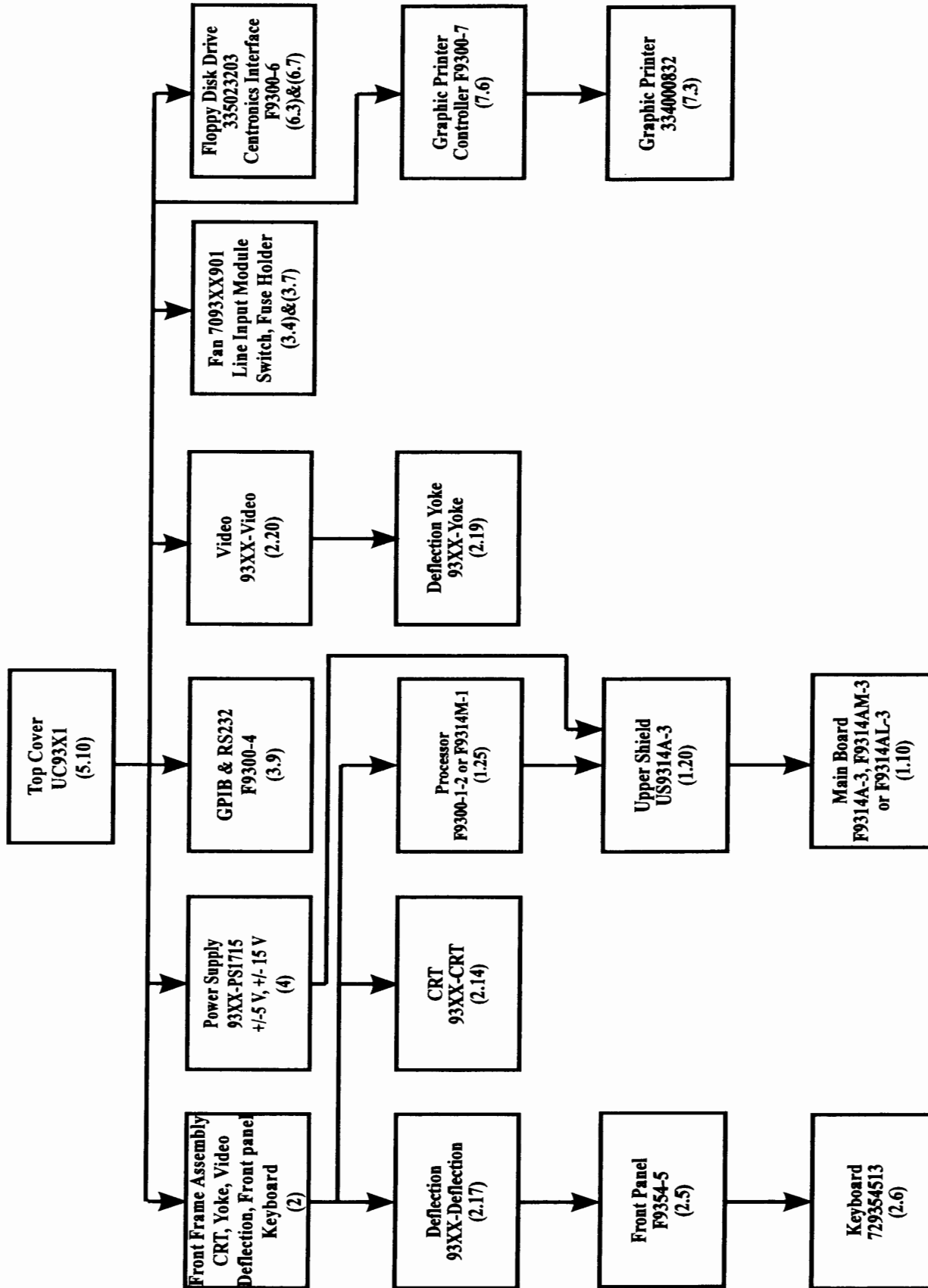

Assembly : Reassemble the unit in the reverse order.

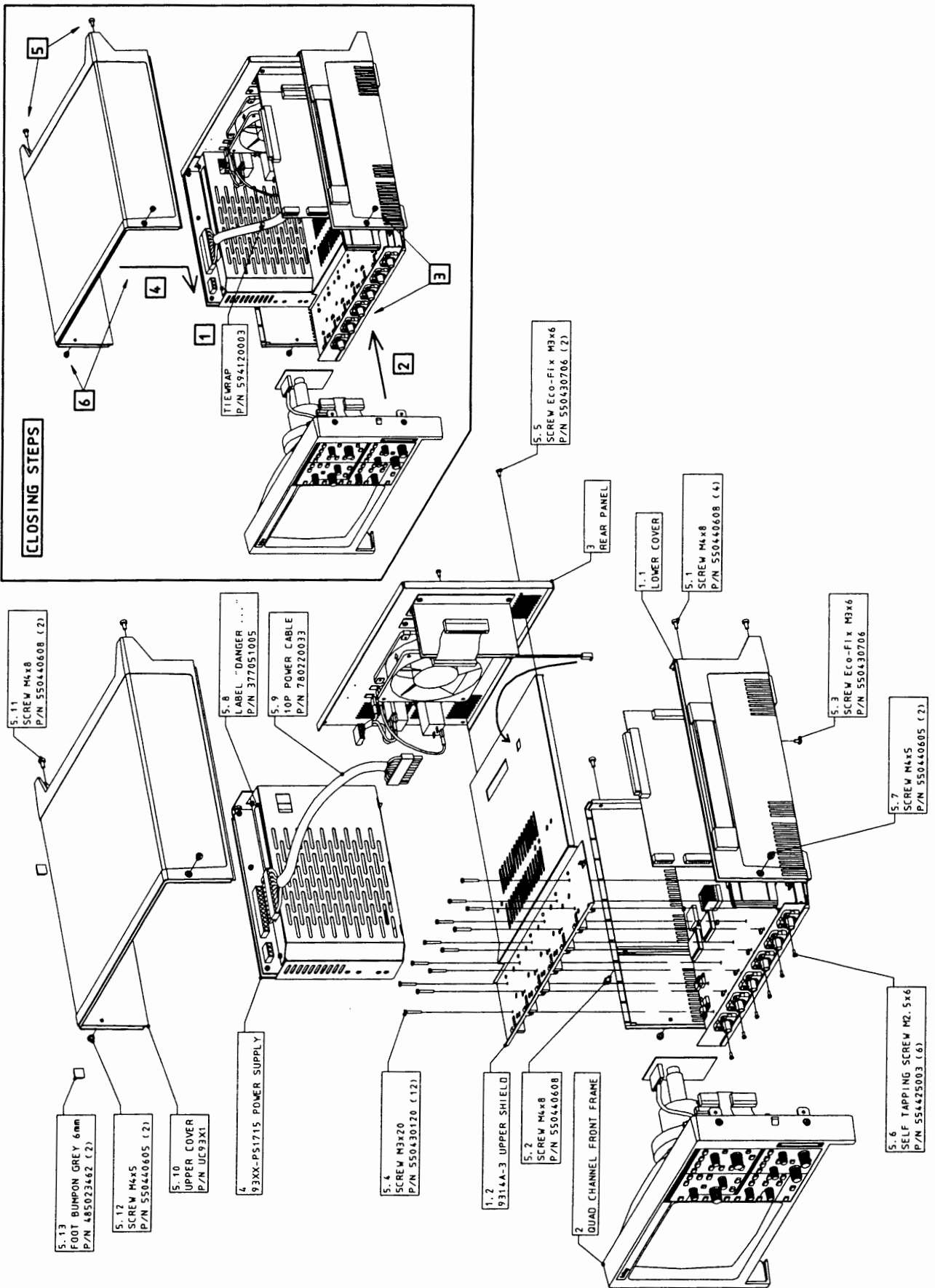

Figure 7.1 : 9314A/M/L Assembly

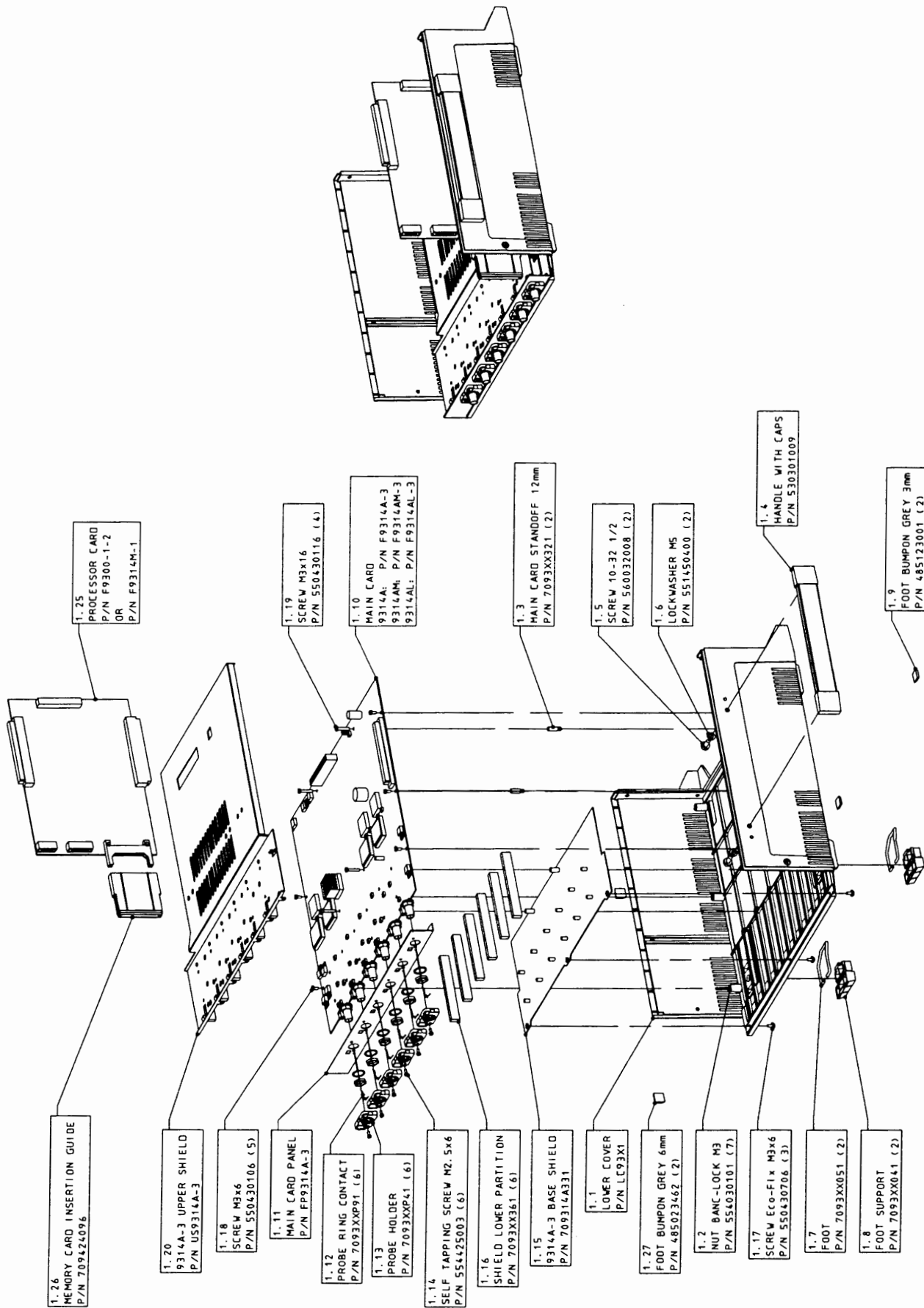

Figure 7.2 : 9314A/M/L Lower Cover Assembly

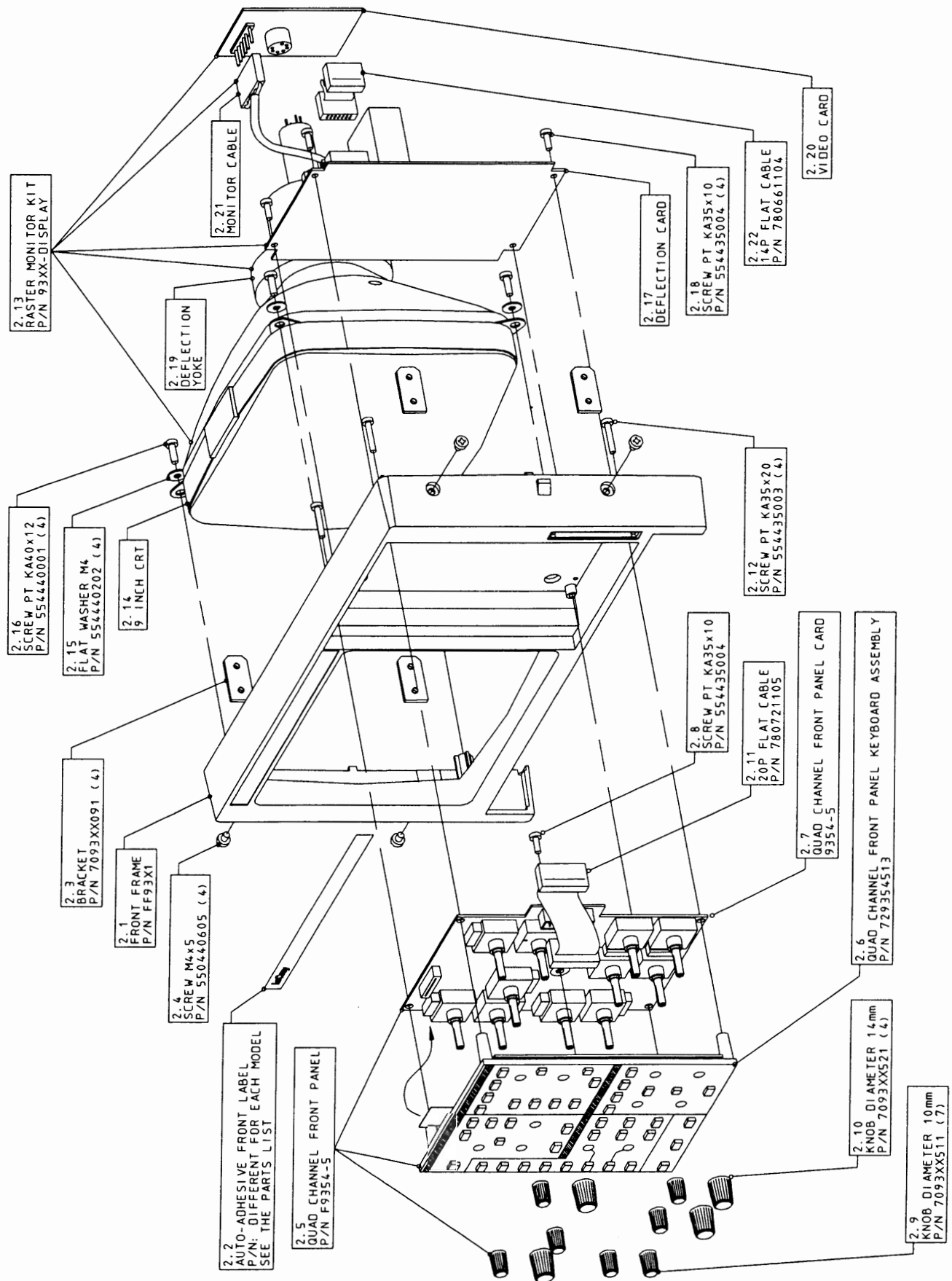

Figure 7.3 : 9314A/M/L Front Frame Assembly

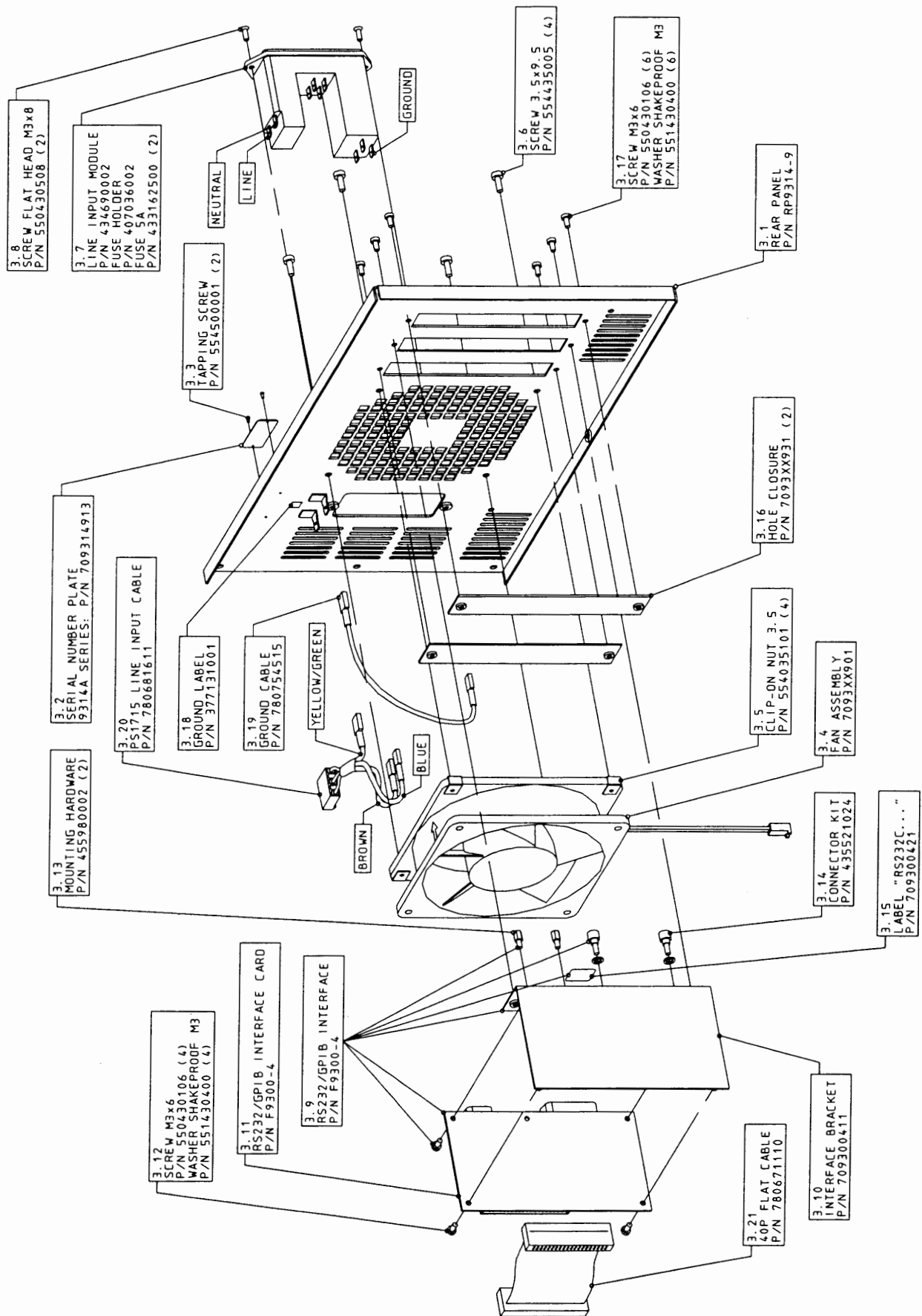

Figure 7.5 : 9314A/M/L Rear Panel Assembly (ECO 1001)

7.2.4 Removal of the F9300-4 GPIB/RS232 Interface (3.9)

The GPIB/RS232 interface (3.9) is vertically mounted on the rear panel (3.1).

Remove the following:

- Top cover (7.2.1).
- Two M3x6 screws (3.17) and washers from the rear panel (3.1).
- Disconnect the flat cable (3.21) from the processor board (1.25) connector J5.

The GPIB/RS232 board can be removed forward from the rear panel.

7.2.5 Removal of the Fan (3.4)

Remove the following:

- Top cover (7.2.1)
- Four screws (3.6) and nuts (3.5) from the rear panel (3.1).
- Disconnect the fan power cable from the main card F9314A-3 connector J3.
- On scope at ECO 1000, remove the fan grid (3.22).

The fan (3.4) part number : 7093XX901 can be removed from the unit.

CAUTION

Note the air flow, the fan extracts air from the unit and expels it.

7.2.6 Removal of the Line Input module (3.7)

WARNING

Disconnect the power cord.

Remove the following:

- Top cover (7.2.1).
- Two screws (3.8) from the rear panel.
- Disconnect the power cable from the power supply connector.
- Disconnect the earth cable (3.19).

The fuse holder assembly (3.7) can be removed from the rear panel (3.1).

7.2.7 Removal of the 93XX-Video (2.20)

- Remove the top cover (7.2.1).
- Disconnect the ground cable from CRT (black wire)
- Disconnect the monitor cable (2.21) from the deflection board, connector W301 & W302

Ease the video board (2.20) carefully toward the back of the DSO, until it is free.

7.2.8 Removal of the 93XX-Yoke (2.19)

- Remove the top cover (7.2.1).
- Remove the 93XX-video board (7.2.7)
- Disconnect the cable from the deflection board connector W201.
- Loose the screw on the yoke ring holder.

The deflection yoke (2.19) can be removed from the cathode ray tube (2.14).

7.2.9 Removal of the front frame Assembly (2)

Remove the following:

- Top cover (7.2.1)
- Two screws (5.7) that secure the front frame assembly (2) to the lower cover (1.1).
- Disconnect the front panel flat cable (2.11) from the processor (1.25) connector J4.
- Disconnect the deflection flat cable (2.22) from the processor board (1.25) connector J6.

The front frame assembly (2) with the CRT (2.14), yoke (2.19), video (2.20), deflection (2.17), front panel (2.7) and keyboard (2.6) can with care be removed forward from the unit.

CAUTION

Hold the CRT very carefully, or place soft padding under it.

7.2.10 Removal of the 93XX-Deflection (2.17)

The deflection board (2.17) is situated to the back of the front panel (2.5).

Remove the following

- Top cover (7.2.1).
- Front frame assembly (7.2.9).
- Disconnect the monitor cable (2.21) which lead to the video board (2.20), connector W301 and W302.
- Disconnect the cable from the deflection yoke, connector W201.
- Disconnect the EHT plug from the receptable at the right side of the CRT (2.14).

WARNING

Touch the free end of the EHT cable to the ground, this ensures that no significant charge remains. The CRT must be discharged similarly, using a tool or a long screw driver which is first placed to the ground and on the CRT receptable.

Remove the four M35x10 screws (2.18) that secure the deflection board to the plastic front frame.

The board (2.17) can now be removed from the unit.

7.2.11 Removal of the 93XX-CRT (2.14)

It is necessary to remove the front frame assembly (7.2.9). The CRT is secured to the plastic front frame by four screws (2.16).

- Remove the 93XX-video (7.2.7).
- Remove the 93XX-yoke (7.2.8).
- Disconnect the EHT cable from the deflection board. Discharge the tube.
- Remove the four screws.

The CRT can now be removed from the front frame.

W A R N I N G

Use care when handling the CRT. Avoid striking it on any object which may cause the tube to implode. Store the cathode ray tube face down on a soft surface. To avoid electrical shock the CRT should be discharged after the 9314A/M/L oscilloscope is powered OFF. After disconnecting the EHT plug, ground the CRT anode lead to the metallic display support, repeat the operation to fully dissipate the charge.

7.2.12 Removal of the F9354-5 Front Panel (2.5)

Remove the following:

- Upper cover (7.2.1).
- Front frame assembly (7.2.9).
- 93XX-deflection board (7.2.10).
- Four screws (2.12) that secure the front panel.

The front panel (2.5) with the keyboard (2.6) can be removed forward from the unit.

7.2.13 Removal of the Front Panel Keyboard (2.6)

Remove the following:

- Upper cover (7.2.1).
- Front frame assembly (7.2.9).
- 93XX-deflection board (7.2.10).
- F9354-5 front panel (7.2.12).
- The 11 rotary knobs (2.9 and 2.10). Take great care of the soft plastic
- One screw (2.8) that secures the keyboard to the front panel.
- Disconnect the flat ribbon cable from the front panel connector J2, and remove the keyboard P/N : 729354513.

C A U T I O N

When removing or installing the keyboard or the front panel, be careful of the fragile flat ribbon cable and connector.

7.2.14 Removal of the Processor (1.25)

The processor F9300-1-2 or F9314M-1 board is located along the right side of the instrument.

Remove the following:

- Top cover (7.2.1).
- Front frame assembly (7.2.9).
- Disconnect the flat cable (3.21) from the F9300-4 GPIB interface connector J5

The processor can be removed vertically from the main card (1.10) F9314A/M/L-3 connector J1

CAUTION

Static electricity can damage components (RAM, Eeproms, microprocessor...). Antistatic precautions are required.

7.2.15 Removal of the F9314A/M/L-3 Main Card (1.10)

Remove the following:

- Top cover (7.2.1).
- Front frame assembly (7.2.9).
- Power supply (7.2.2).
- Processor (7.2.14).

The main board with the upper shield (1.2) is horizontally mounted to the lower case cover (1.1).

- Remove the twelve M3x20 screws (5.4), two M3x6 (5.5) and six M2.5x6 (5.6) that secure the upper shield (1.2) to the main board, rear panel and front panel.
- Disconnect the fan cable from connector J3.

The upper shield (1.2) can be removed forward from the main board.

- Remove the five M3x6 screws (1.18), four M3x16 (1.19) and three M3x6 flat head screws (1.17) that secure the board to the lower cover (1.1).

The main board F9314A/M/L-3 (1.10) with base shield (1.15) and card panel (1.11) can be removed from the scope.

CAUTION

Antistatic precautions are required.

7.2.16 Removal of the Handle (1.4)

The handle with two black end caps is secured to the right side of the lower cover (1.1) by two screws (1.5) and washers (1.6).

- Remove the upper cover (7.2.1), and processor board (7.2.14).

The handle can be removed from the lower case.

7.2.17 Removal of the Foot Support (1.8)

The two foot supports are clipped on the lower cover (1.1).

- Remove the foot (1.7) or the support (1.8) by inserting a small flat screwdriver under the support

7.2.18 Removal of the 93XX-FD01 Floppy Disk Drive Option

- Remove the upper cover (7.2.1).
- Disconnect the flat ribbon cable from the F9300-6 interface (see figure 7.6).
- Remove the two M3x6 screws that secure the floppy drive support to the upper cover.
- Remove the support 70FD01021 and frame 70FD01031 from the cover.
- Remove the four M2.5x4 screws that secure the floppy to the support

The floppy disk drive (6.3) p/n: 335023203 can be removed from the frame

7.2.19 Removal of the 93XX-GP01 Graphic Printer and F9300-7 Controller Option

- Remove the upper cover (7.2.1).
- Disconnect the power cable (7.13) from the 93XX-PS1715 power supply (see figure 7.7).
- Disconnect the flat ribbon cable (780791604) from the F9300-7 controller (see figure 7.7).
- Disconnect the flat ribbon cable (780721022) between the F9300-6 interface and F9300-7 controller.
- Remove the four M3x6 screws that secure the F9300-7 controller to frame (70GP01031).
- Remove the F9300-7 controller
- Remove the two M3x6 screws that secure the printer to the frame

The graphic printer (7.3) can now be removed from the upper cover.

7.2.20 Removal of the F9300-6 Centronics Interface Option

- Remove the upper cover (7.2.1).
- Remove the two M3x6 screws from the rear panel
- Disconnect the flat cable from the F9300-4 GPIB/RS232 board (see figure 7.6 or 7.7).

The graphic printer, floppy disk drive, and centronics interface board can be removed forward from the rear panel.

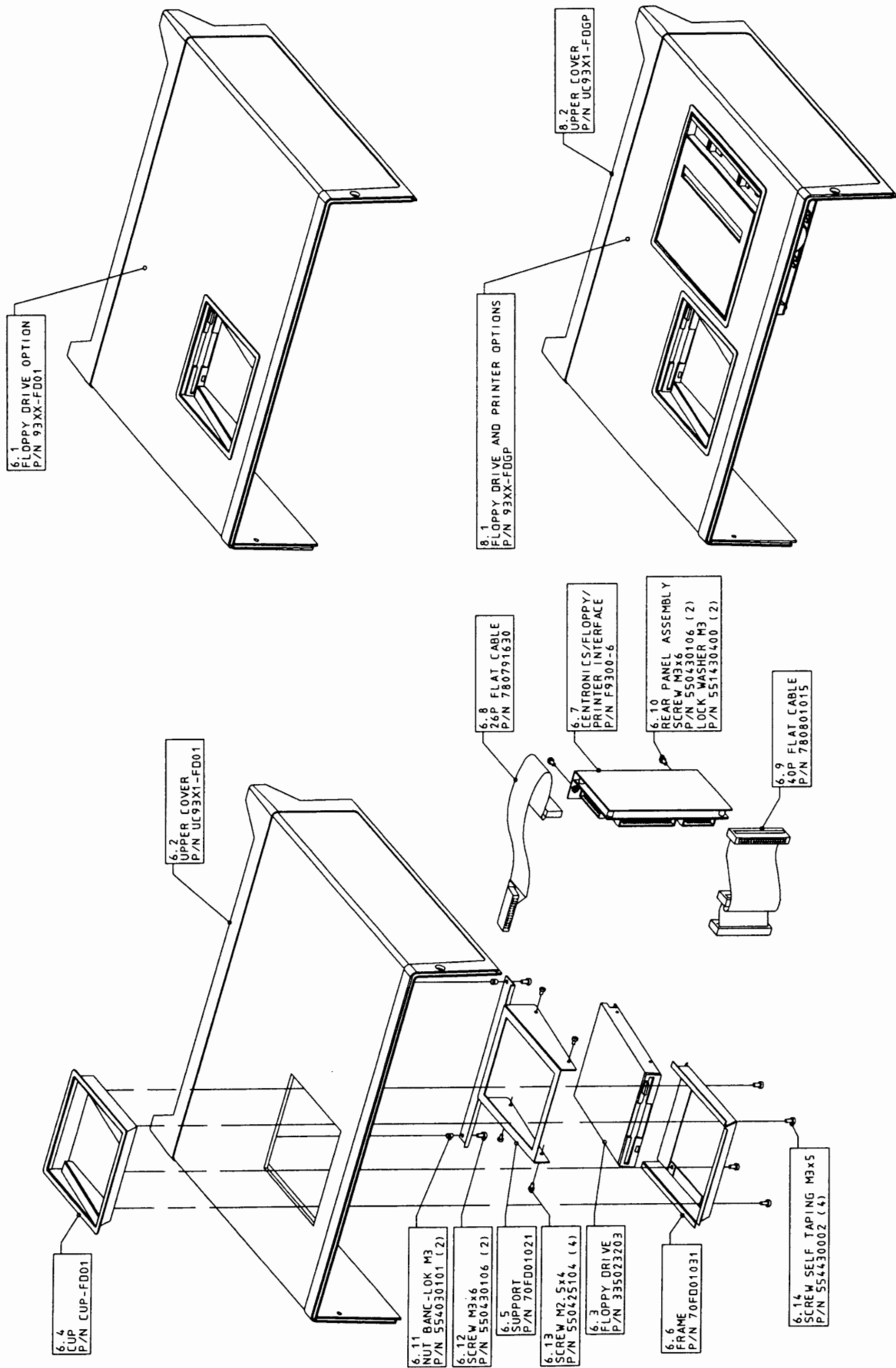

Figure 7.6 : 9314A/M/L Floppy Option Assembly

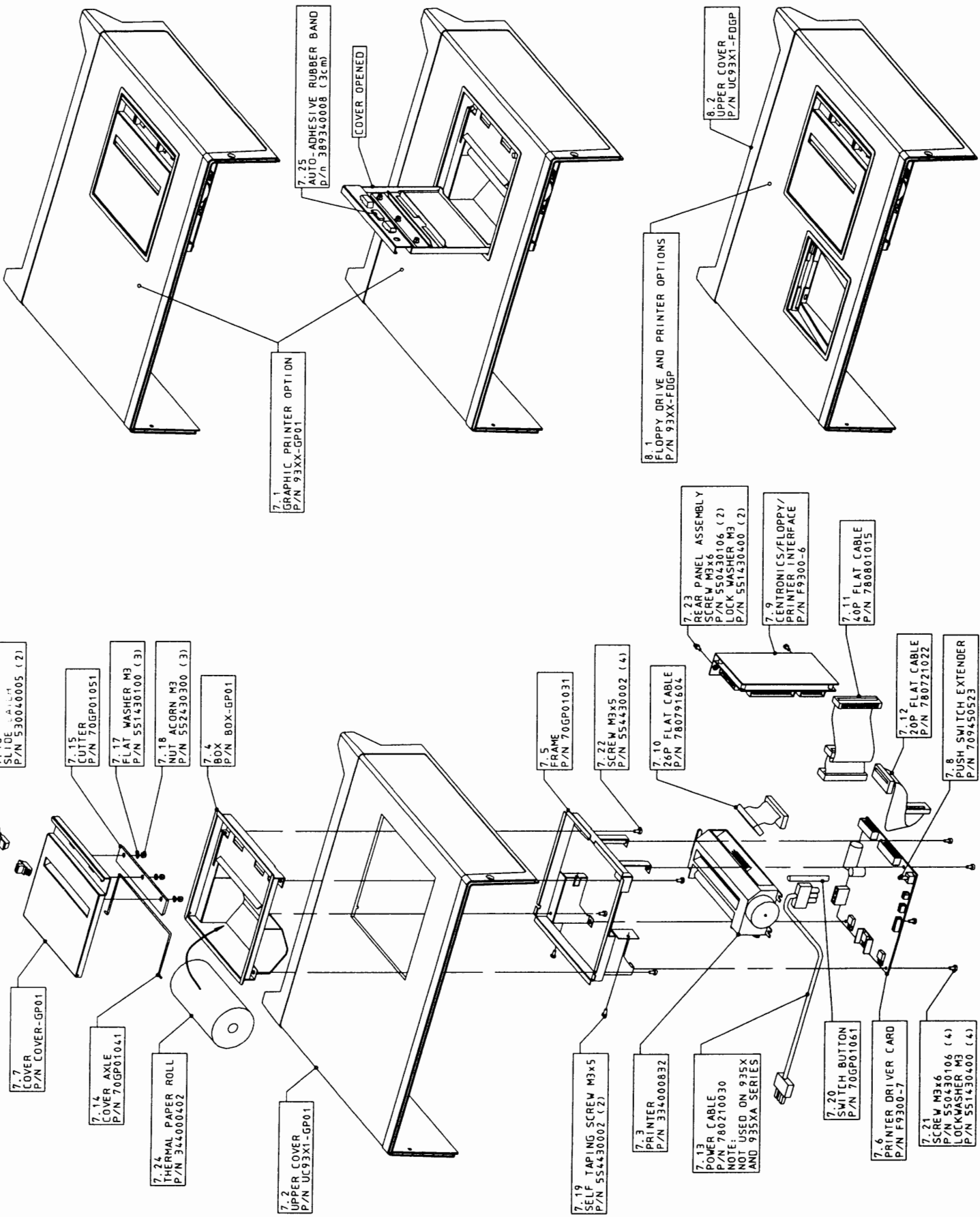

Figure 7.7 : 9314A/M/L Graphic Printer Assembly

7.3 Software Upgrade Procedure

F9314M-1 or F9300-1-2 processor for 9314A/M/L DSO, carries four 2 MB Eprom (Loc A22, A27, A29, A38) or two 4 MB Eprom for the Firmware, and one Eprom (Loc A1) for the character font used by the graphic processor of the raster scan display.

After any software change, a general instrument reset is mandatory. Simultaneously press the autosetup button, the top menu button and the return button.

7.3.1 Upgrading Firmware

LeCroy Corporation has a policy of continually improving and upgrading its products.

The firmware can be upgraded to the latest version by changing the Eproms on the processor board at locations A22, A27, A29, A38.

Access is possible by removing the upper cover (7.2.1), the Eprom can be removed by using an IC extractor, make sure that the guiding notch in the chip is aligned with the PCB.

7.3.2 Changing Software Options

The software option selection GAL is located on the processor board at location A19. Insert or replace the GAL to select new options.

Make sure that the orientation notches are correctly aligned with the PCB.

7.3.3 Software Option Selection GAL

The following software options are available:

0000	:	Standard	GAL not necessary
0001	:	WP01	Advanced Math package
0002	:	WP02	Basic FFT package
0200	:	CARD	Memory card

OPTIONS			
Memory Card	WP02	WP01	GAL DESCRIPTION
no	no	no	GAL NOT NECESSARY
no	no	yes	CLE 001-A
no	yes	no	CLE 002-A
no	yes	yes	CLE 003-A
yes	no	no	CLE 200-A
yes	no	yes	CLE 201-A
yes	yes	no	CLE 202-A
yes	yes	yes	CLE 203-A

GAL CLE XXX-R : XXX : Software option, R : Release

7.3.4 Processor Board Exchange Procedure

The replacement board is supplied without any firmware or options. Therefore the existing GAL (Loc A19) and eproms (Loc A22, A27, A29, A38) must be transferred from the faulty board to the new board. After upgrading firmware or changing the software option, check that the scope boots correctly. Then check in the system summary, by using the show status button on the front panel, the software version, software options and serial number.

The serial number of the 9314A/M/L oscilloscope is loaded in the real time clock memory which is battery backed up. If it becomes necessary to replace the processor board, the serial number must be loaded in the memory of the new board by using LeCroy program " LeCalsoft " under GPIB remote control.

To run " LeCalsoft " type SKP.exe, in the main menu type S, and follow the instructions, use five digits to enter the serial number (i.e. 03242).

25-Jan-91
1:17:20

STATUS

Serial Number 931403242
Soft Version 9314AL 04.0
Soft Options
WP01 WP02 CKIO MC01
Hard Options
GPIB R232 CLBZ I2C
Main RAM size 2 Mbytes

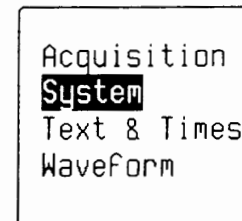

7.4 Equipment and Spare Parts Recommended for Service

7.4.1 Equipment

The following equipment is needed to provide the technician access to the 9314A/M/L subassemblies during repair and calibration (see section 5 and 6).

Instrument	Qty	Specifications	Recommended
Signal Generator (sine wave)	1	Frequency : 500 KHz to 1 GHz Accuracy : 0.001 % Amplitude : 1 V peak to peak	Marconi 2030
Signal Generator (sine wave)	1	Frequency : 5 KHz Amplitude : 6 V peak to peak	Topward TFG-8101
DC precision Power Supply	1	Amplitude : 10 V, DC Accuracy : < 0.1 %	Tektronix PS5004
Digital Multimeter	1	5 digits	Keithley 199
Fast pulser	1	Rise time < 500 psec	LeCroy 4969
Digital scope	1	Bandwith 350 MHz	LeCroy 93XX
Cable	1	BNC, 50 Ω , length 20 cm (7.87 inches)	Suhner
Cable	1	BNC, 50 Ω , length 100 cm (39.37 inches)	Suhner
BNC T adapter	1	BNC, 50 Ω , T adapter	Suhner

7.4.2 Spare Parts

In order to make the repair of either 9314A or 9314AM or 9314AL oscilloscope at board level, a minimum stock of boards is at least one each:

- F9300-1-2 : Processor board for 9314A/M/L DSO's
- F9314A-3 : Main board for 9314A
- F9314AM-3 : Main board for 9314AM
- F9314AL-3 : Main board for 9314AL
- F9300-4 : GPIB/RS232 interface
- F9354-5 : Front panel with keyboard
- 93XX-Display : Raster monitor kit
- 93XX-PS1715 : Power supply

If the unit is equipped with the 93XX-FD01 option :

- F9300-6 : Floppy, Graphic printer, Centronics Interface
- 335023203 : Floppy disk drive

If the unit is equipped with the 93XX-GP01 option :

- F9300-6 : Graphic printer, Floppy, Centronics Interface
- F9300-7 : Graphic printer controller
- 334000832 : LPT5446 Seiko Graphic printer

The other parts (fan, fuse holder, scope handle, covers, rear panel...) are not on the above list because they are reliable parts and the probability of failure is very low.

7.5 Troubleshooting and Flow Charts

7.5.1 Introduction

The troubleshooting information contained in this section is intended for use by qualified personnel having a basic understanding of electronics (analog and digital). In order to simplify servicing and minimize downtime, the following list of possible symptoms, likely causes, and troubleshooting steps have been prepared.

The first step in troubleshooting is to check for obvious items like blown fuses. The power supply is the next item to check before proceeding to more detailed troubleshooting, since noise or low power supply voltages can cause a variety of digital and analog problems.

7.5.2 Line Voltage Autoranging

The 9314A/M/L oscilloscope operates from a 115 V (90 to 130 V) or 220 V (180 to 260 V) normal power source at 47 Hz to 63Hz.

No voltage selection is required since the instrument automatically adapts to the line voltage which is present. The instrument operates at line frequencies up to 440 Hz.

However, at frequencies above 60 Hz, the leakage current from phase to ground slightly exceeds the safety recommendations for industrial instruments in some countries. This current reaches 4 mA Max at 250 V/400 Hz.

7.5.3 Initial Troubleshooting Chart

Most procedures in this section will allow troubleshooting down to the **BOARD LEVEL**.

Defective circuit boards will be repaired or exchanged by the regional LeCroy service office or the local representative (see section 1.4).

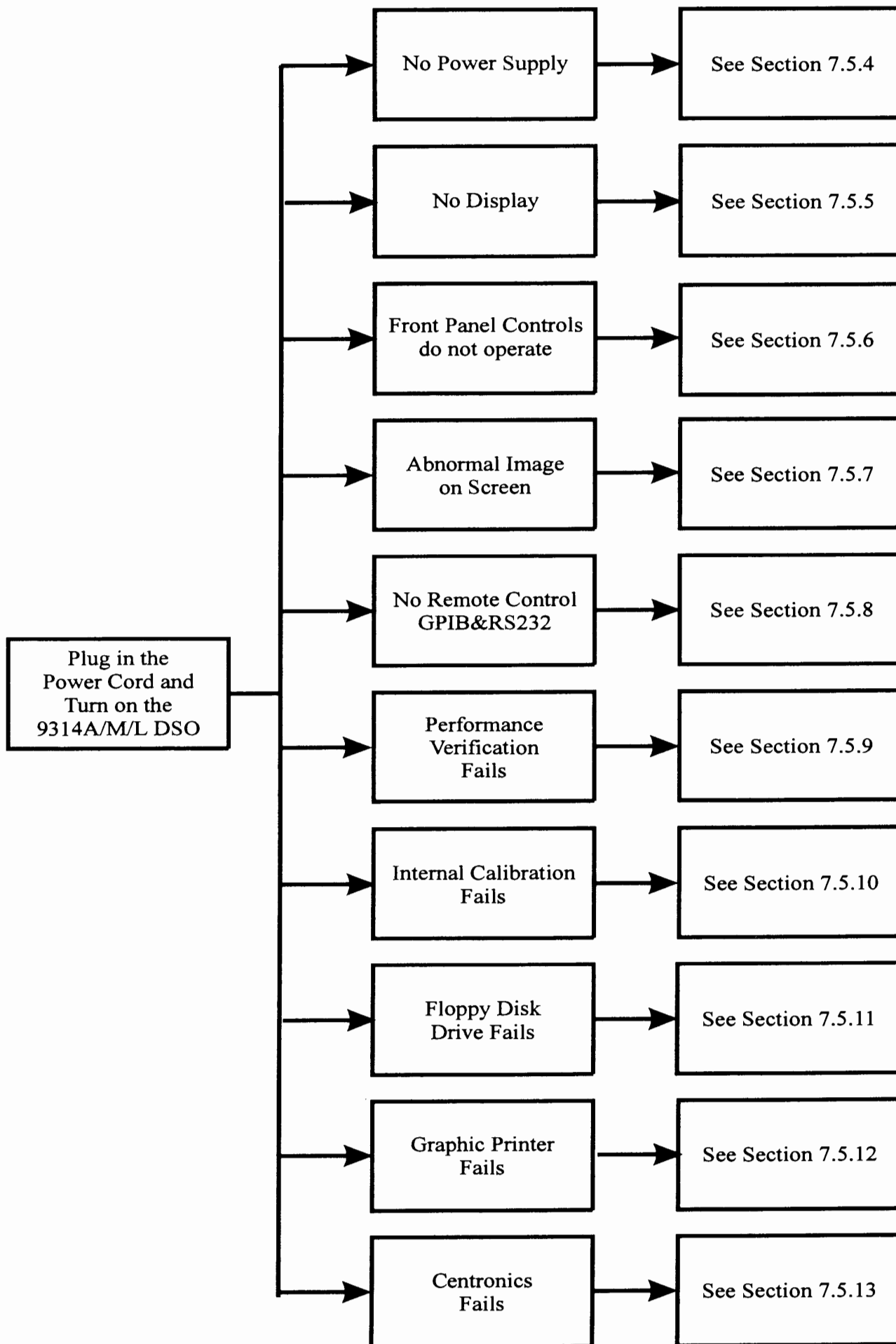

7.5.4 No Power Supply

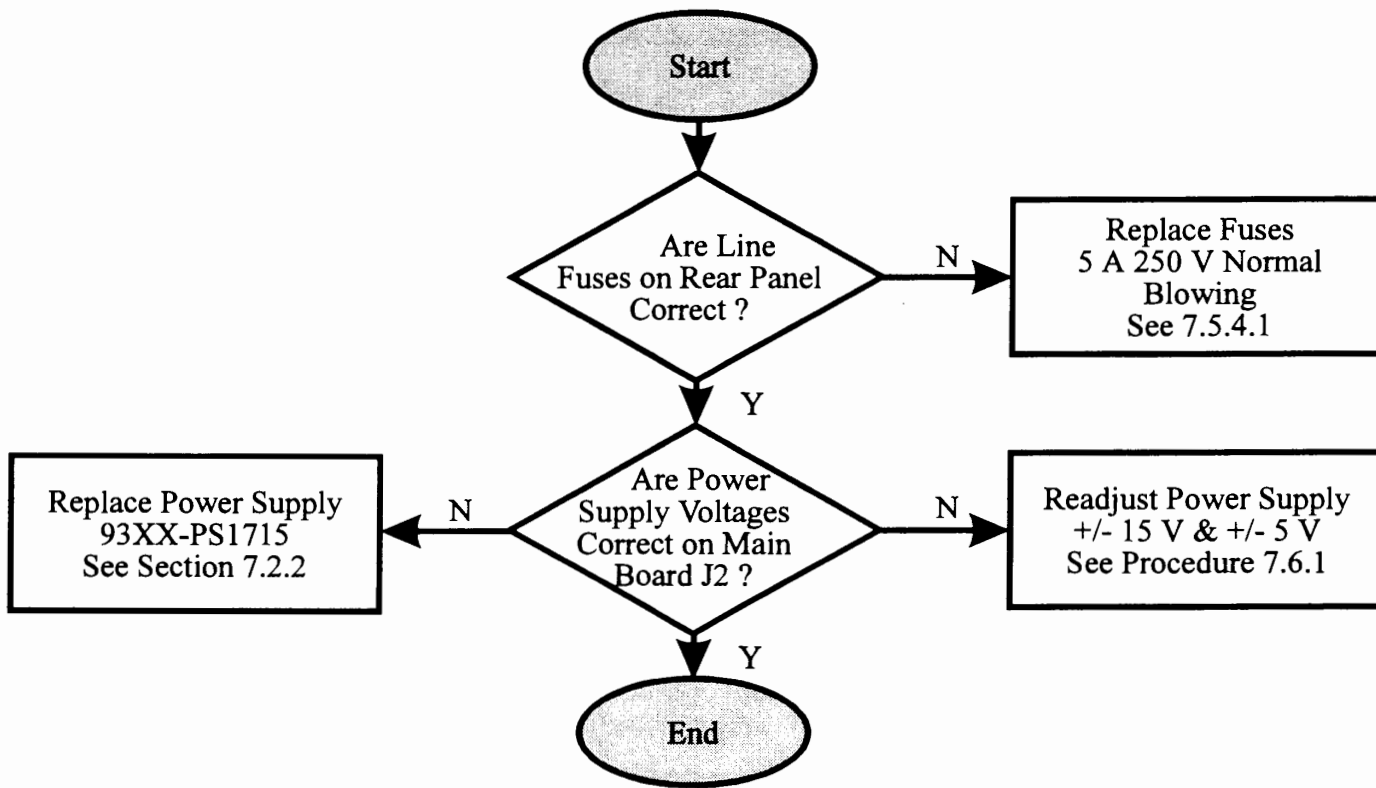

7.5.4.1 Line Fuses Replacement

The power supply of the oscilloscope is protected against short circuits and overload by means of two 5 A / 250 V fuses located above the main plugs.

WARNING

Disconnect the instrument from the power line and from other equipment before replacing fuses.

To replace line fuses, proceed as follow :

- Turn off the power and disconnect the line cord from the instrument
- Open the fuse box by inserting a small flat screwdriver under the plastic cover and remove the fuse carrier from the holder
- Remove the 5 amp fuse and replace it with the proper type:

5 amp/250 V, normal blowing.
LeCroy part number: 433 162 500

7.5.5 No Display

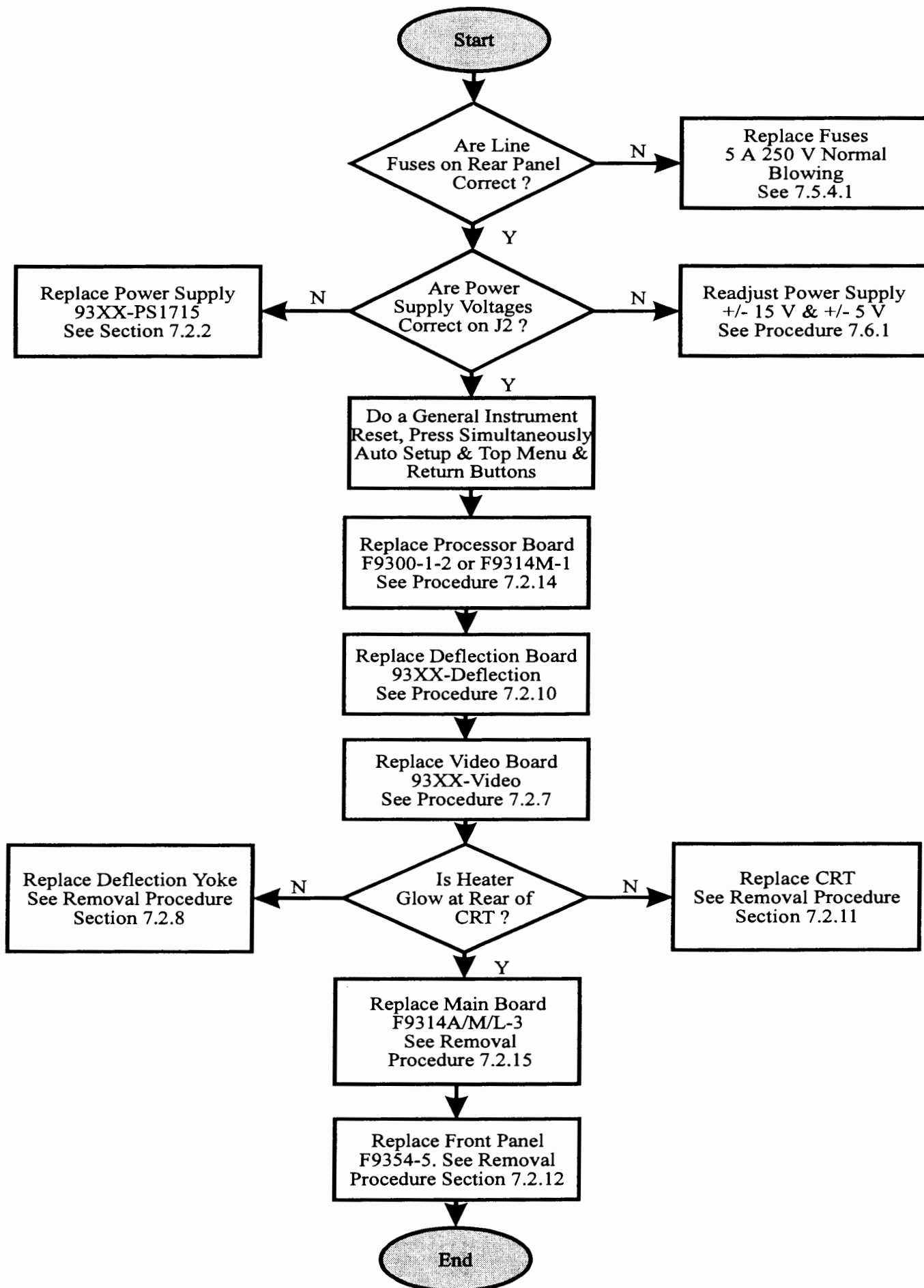

7.5.6 Front Panel Controls Do Not Operate

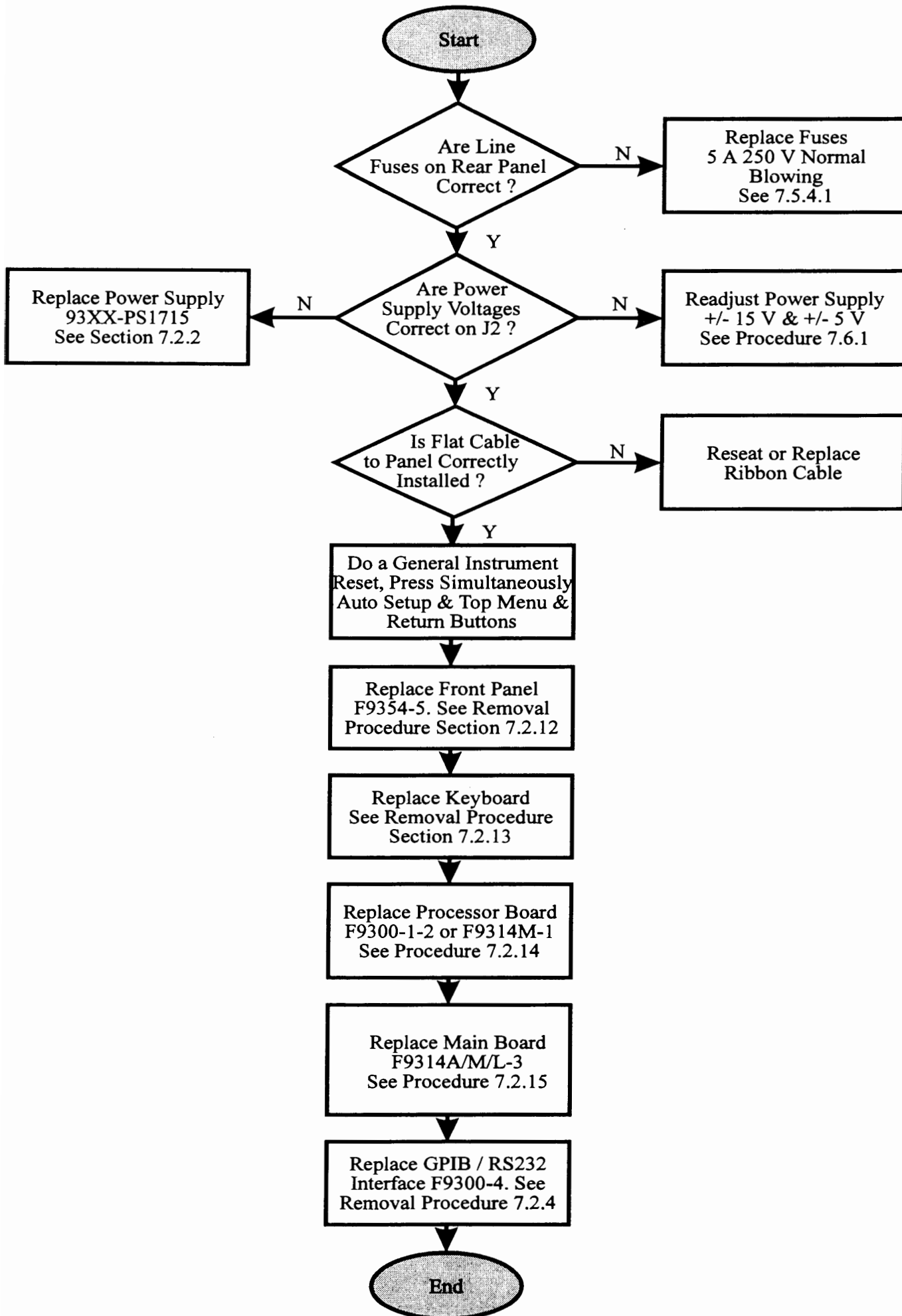

7.5.7 Abnormal Image On Screen

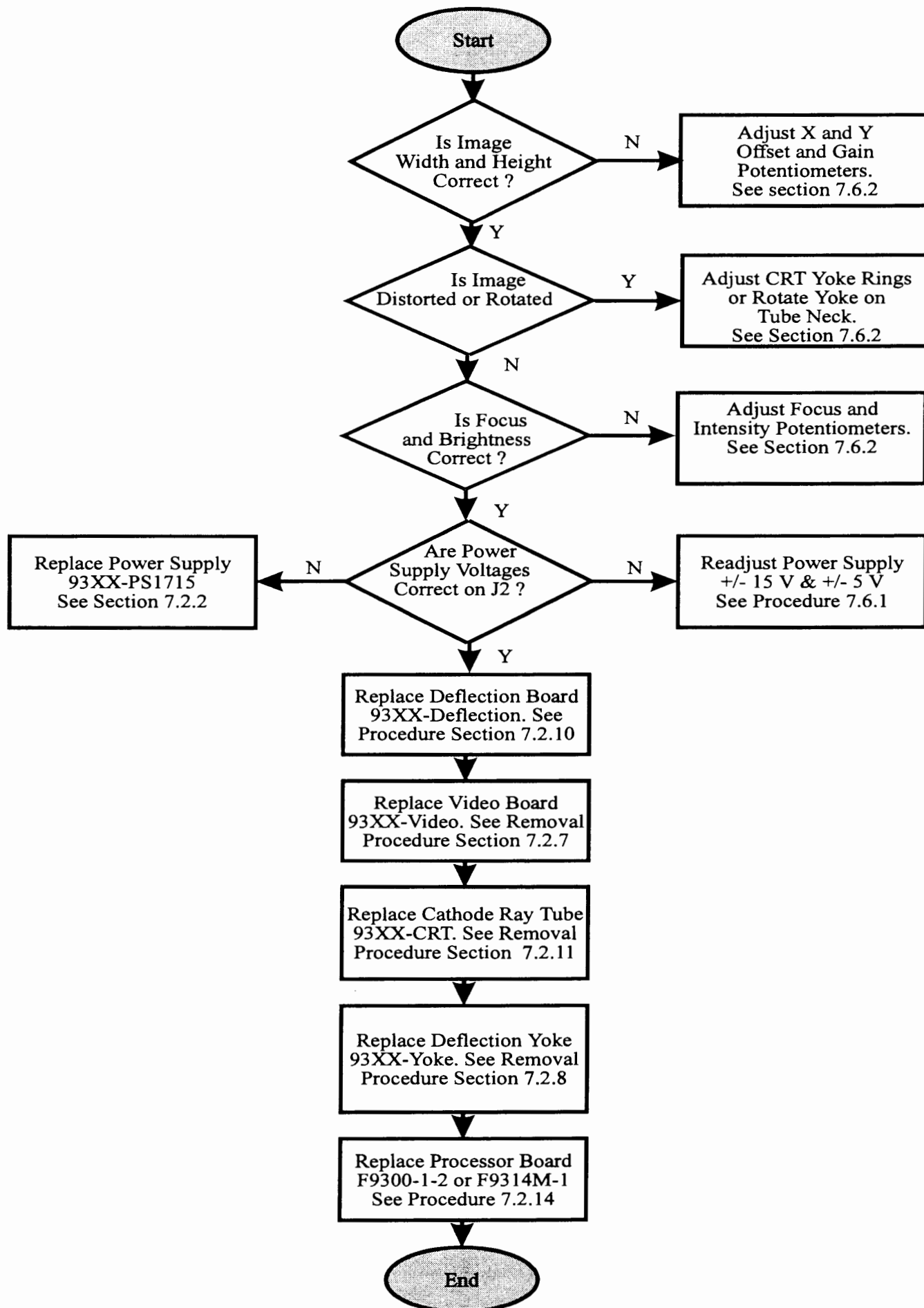

7.5.8 No Remote Control GPIB and RS232

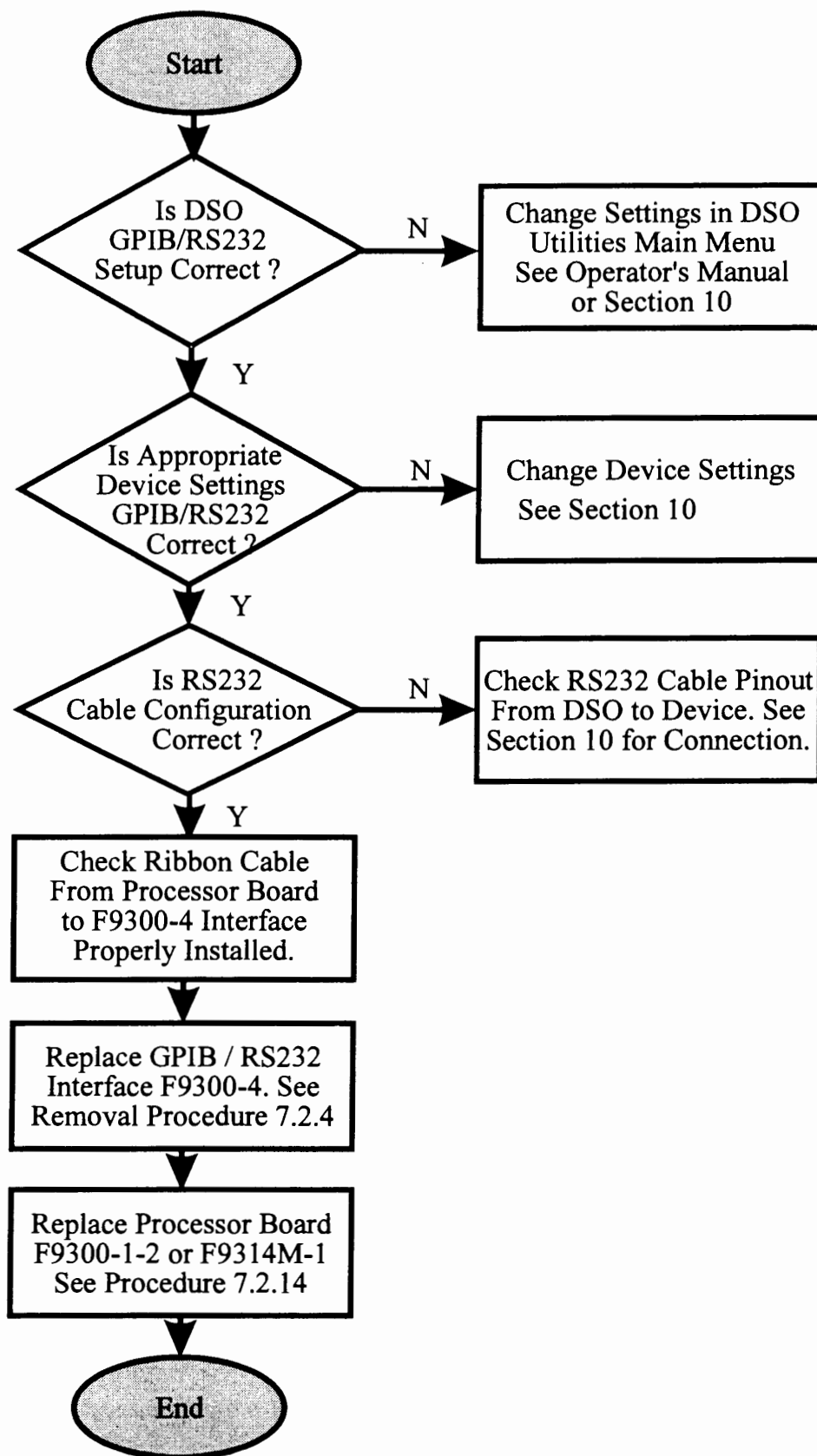

7.5.9 Performance Verification Fails

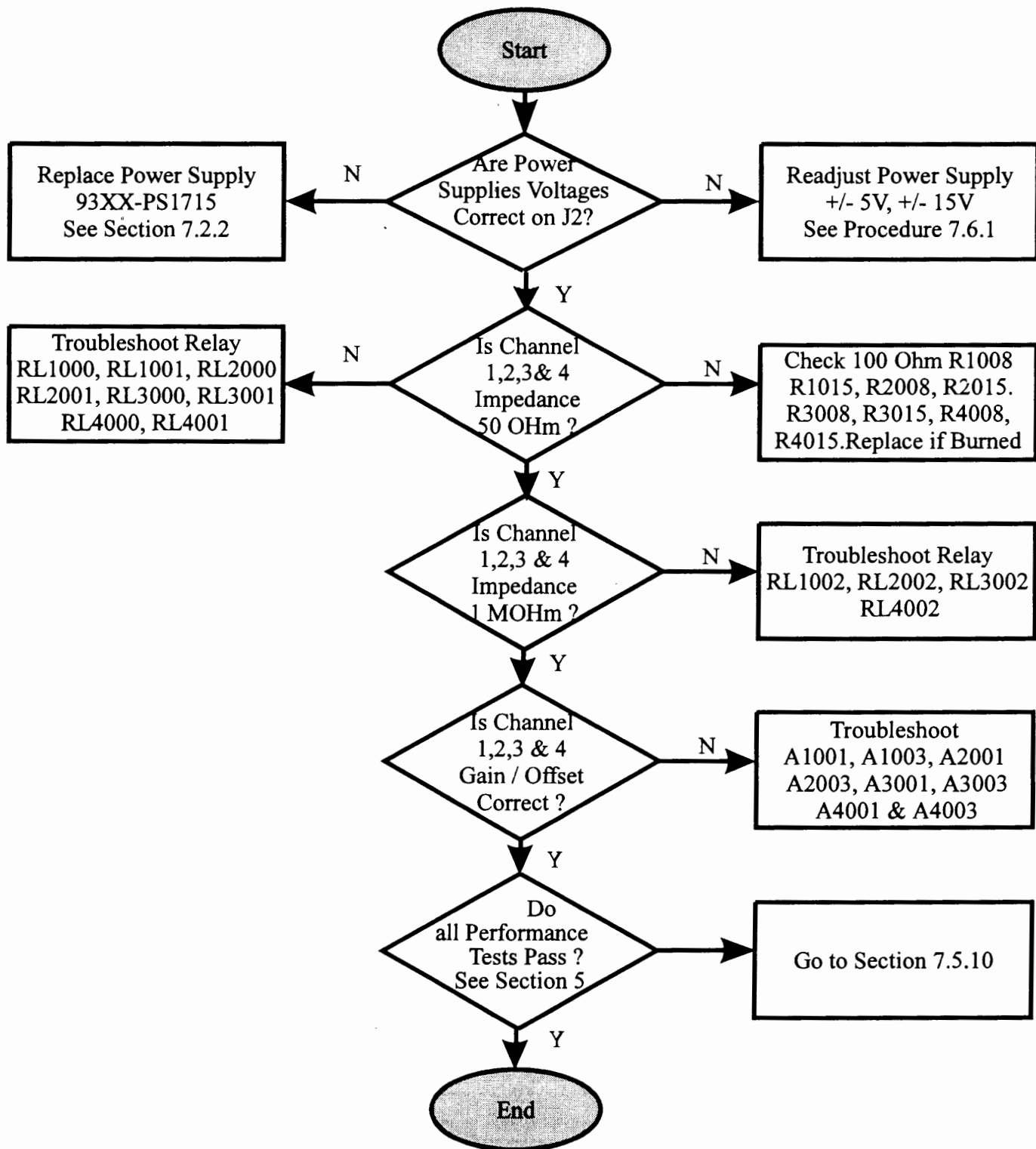

7.5.10 Internal Calibration Fails

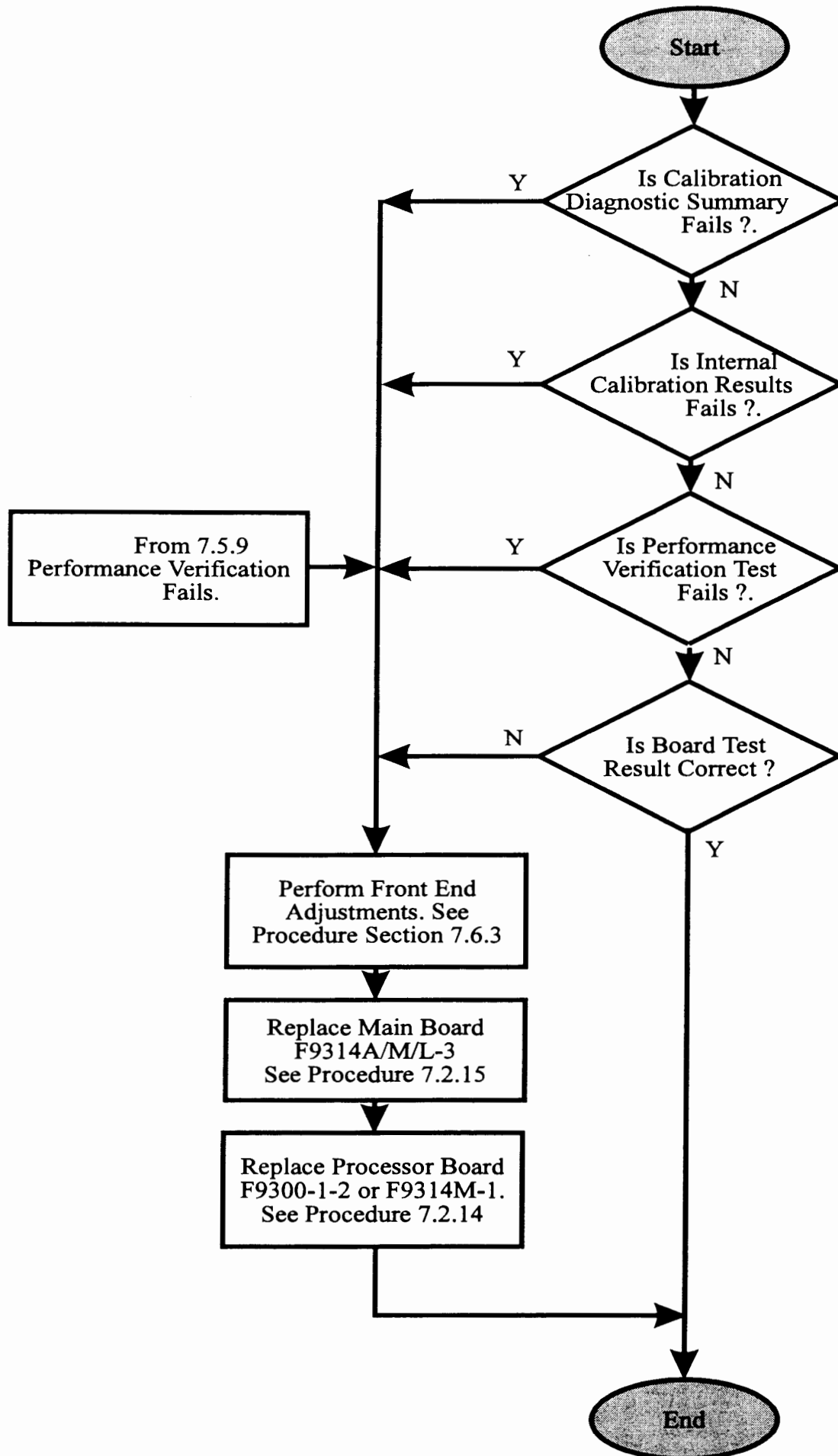

7.5.11 Floppy Disk Drive Fails

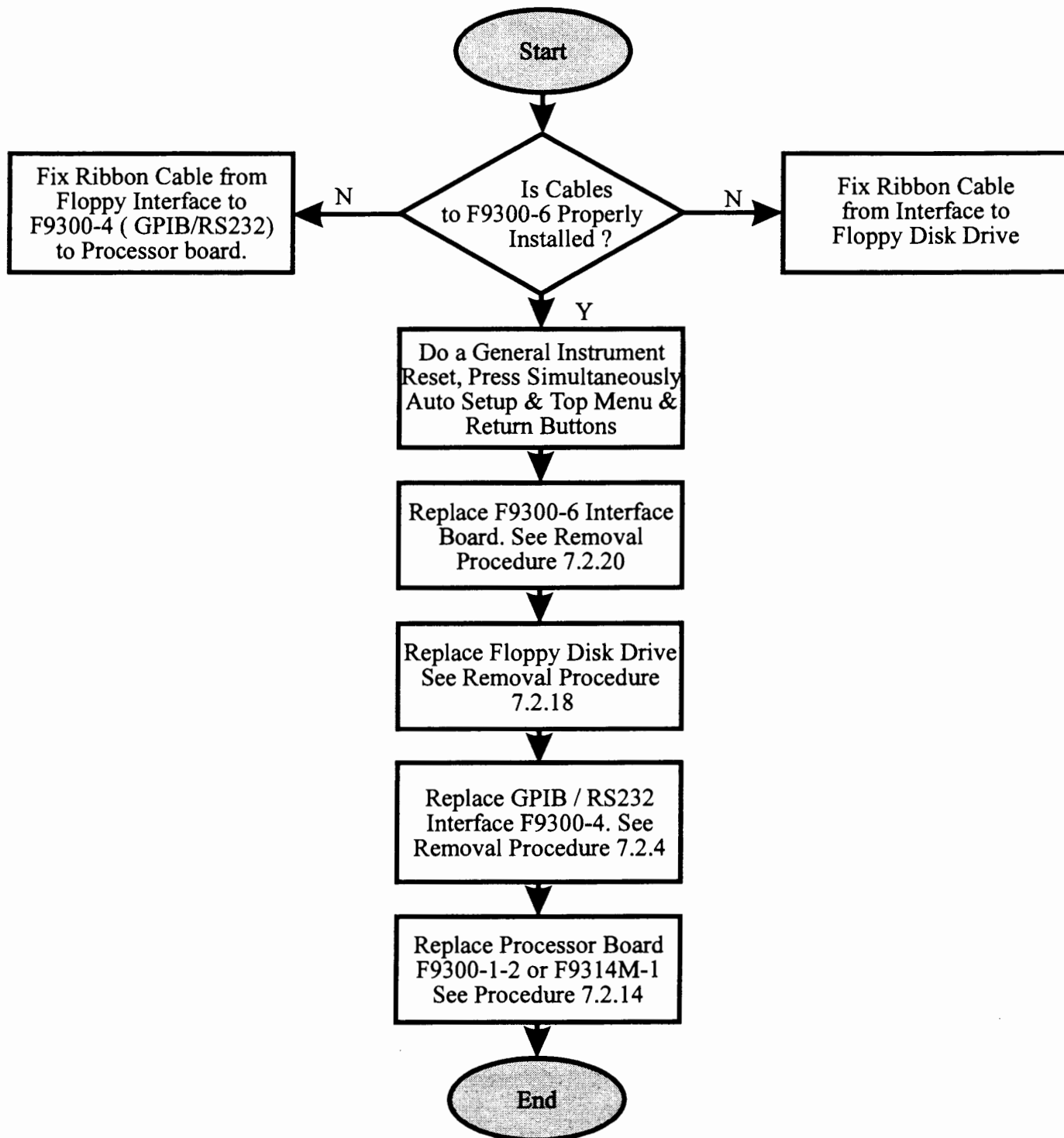

7.5.12 Graphic Printer Fails

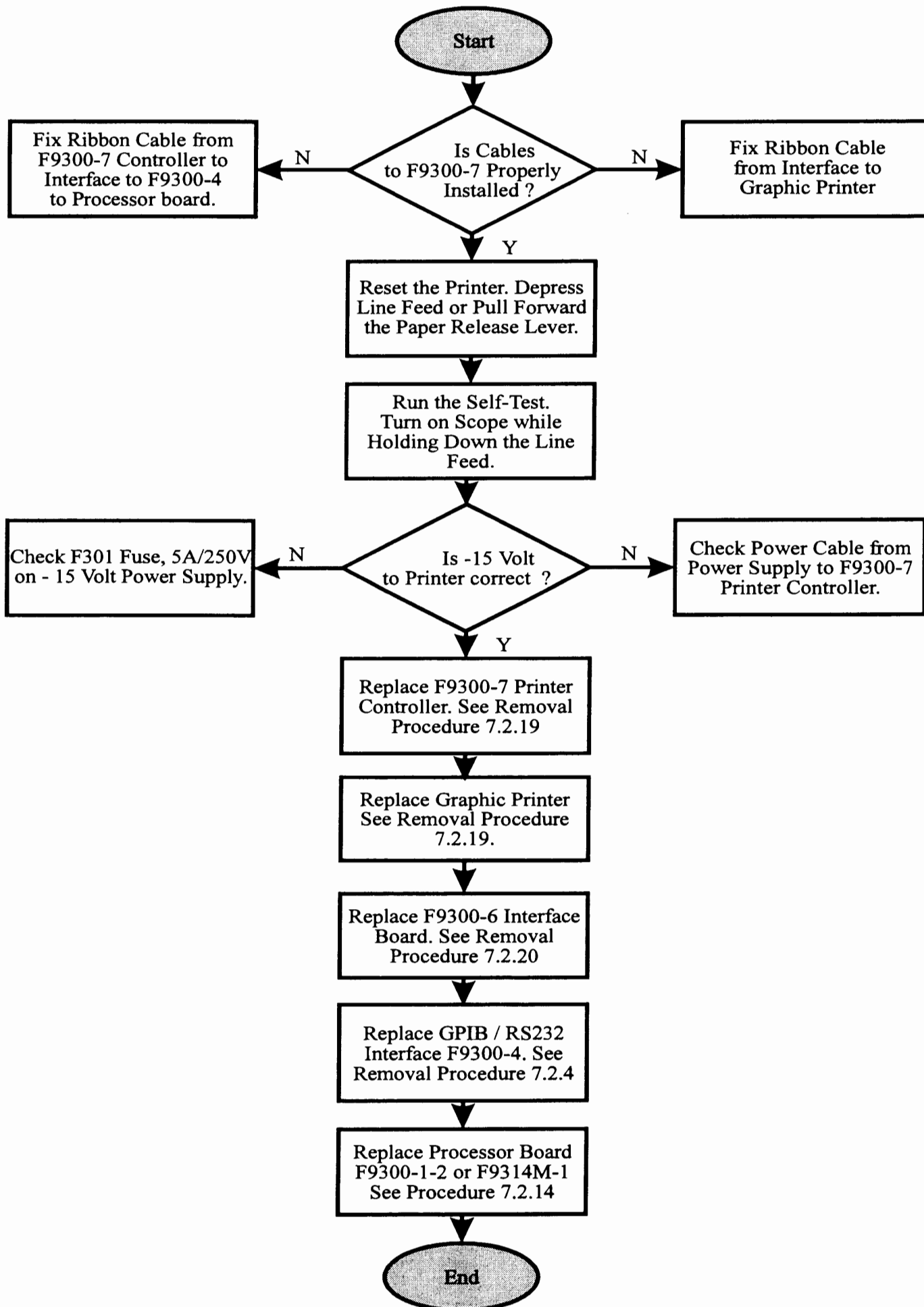

7.5.13 Centronics Fails

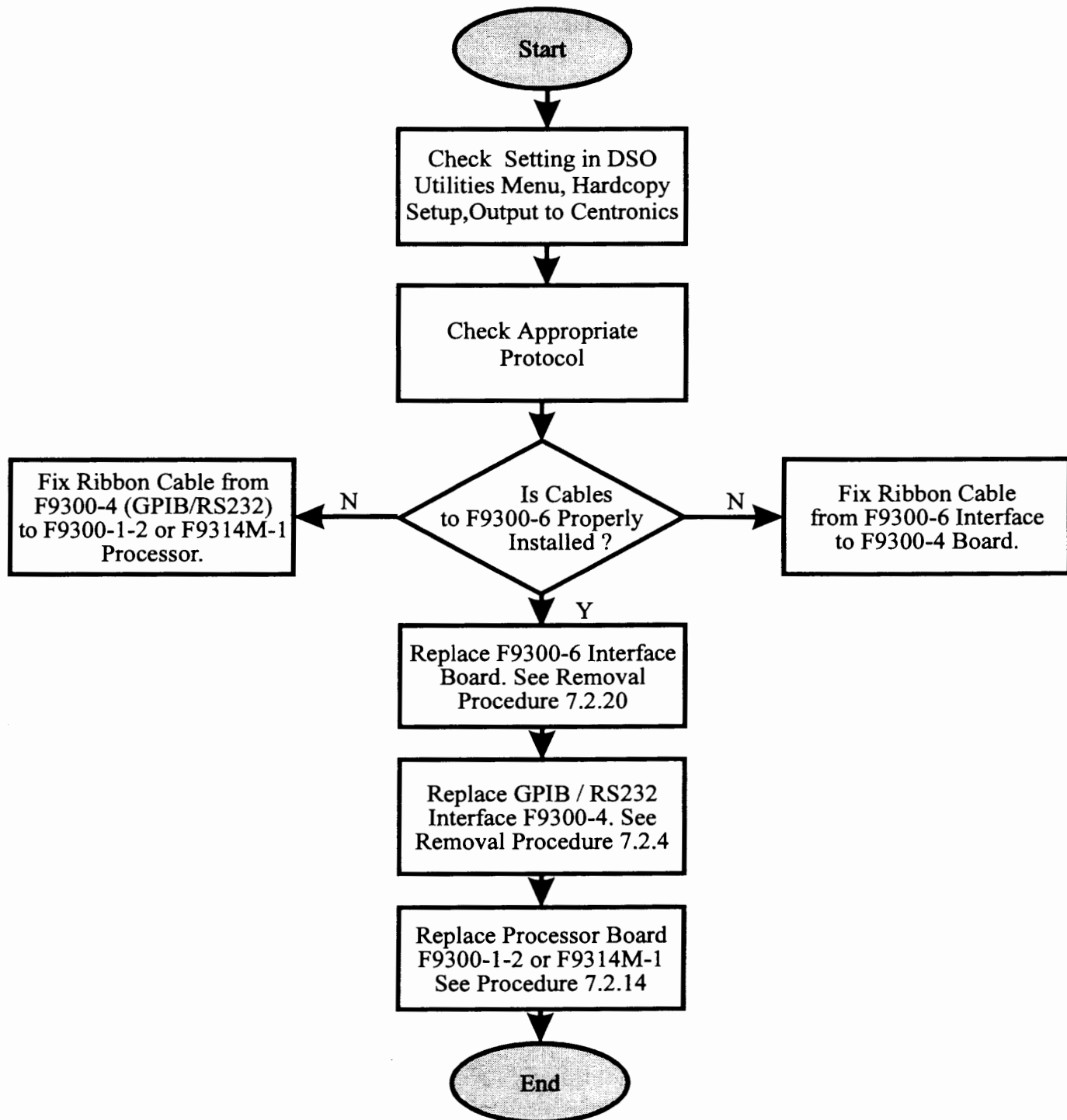

7.6 Calibration Procedures

The following section includes the adjustments required for the power supply, front end and display. It is recommended that they be verified at one year intervals.

7.6.1 93XX-PS1715 Power Supply Calibration

The four voltages are adjustable by $\pm 5\%$ of the nominal value.

The reference for the measurements are the pins on top of connector J2 located on the main board F9314A/M/L-3.

For the power supply calibration proceed as follow:

- Turn off the power
- Remove the top cover (7.2.1)
- Remove the front frame assembly (7.2.9) and put it to the right of the unit.

- By using two extension cables, reconnect the processor board to the front panel (J4) and to the deflection board (J6).

- Once the top cover is removed and the front panel is disassembled from the scope, extra cooling of the main board is required. It's mandatory to disconnect the existing Fan from connector J3, located on F9314A/M/L-3 card, and to use a Fan with the air flow oriented to the front end section of the board.

- The front frame assembly is now reconnected to the processor through the extension cables.

- Turn on the power, set the scope to Auto Trigger, and perform the adjustments to get on J2 (see figure 7. 8).

Pin 3, 5	:	+ 5.10 V (Min = + 5.05 V, Max = + 5.2 V)
Pin 7, 8	:	- 5.2 V (Min = - 5.15 V, Max = - 5.25 V)
Pin 9	:	+15 V (Min = +14.9 V, Max = +15.1 V)
Pin 10	:	- 15 V (Min = -14.9 V, Max = -15.1 V)
Pin 2, 4, 6	:	Ground

The four potentiometers R108, R206, R306, and R407 are accessible from the front through holes in the 93XX-PS1715 power supply chassis.

- Turn the potentiometer clockwise to increase the tension or counterclockwise to decrease the voltage. When the adjustment is done, stop the acquisition by depressing the stop trigger push button, and verify that there is no large difference on the + 5.10 V, typically less than 30 mV.

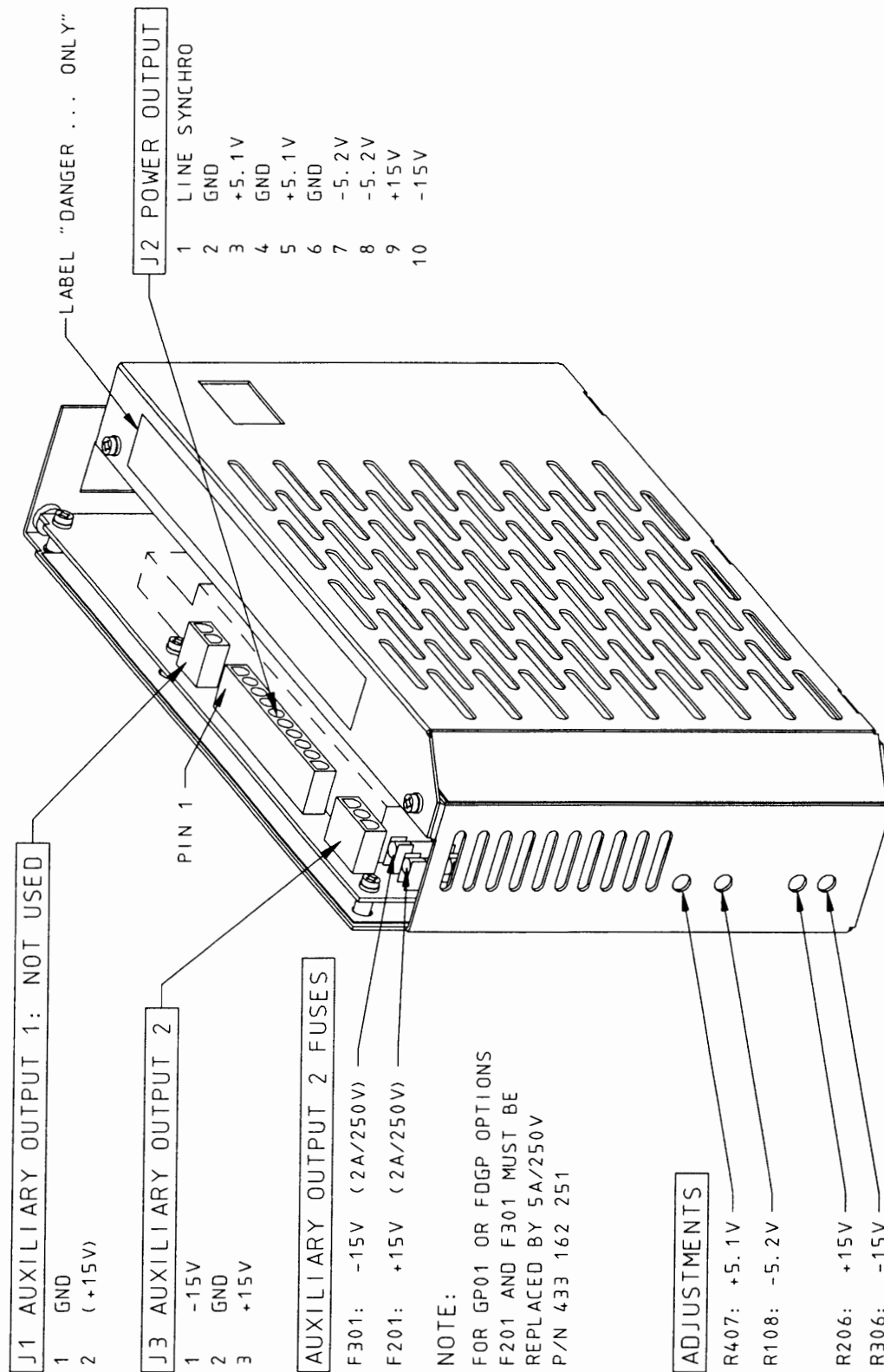

Figure 7.8 : Power Supply

7.6.2 93XX-Display Adjustment Procedure

7.6.2.1 Introduction

There is a total of 12 potentiometers or variable coils to adjust the deflection and video board.

Video: (2 adjustments)

- **Threshold** : Level of the video board.
- **Gain** : Intensity of the screen.

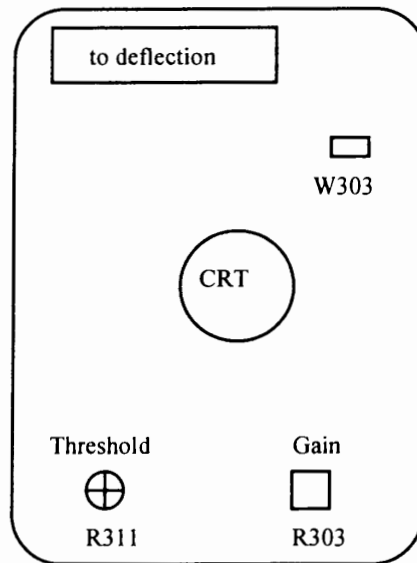

Video board component side

Deflection : (10 adjustments)

- **Vosc** : Frequency of the vertical oscillator.
- **Slope** : Speed of the horizontal ramp.
- **Focus** : Focus of the screen.
- **Cut off** : Cathode ray tube cut off.
- **Quiescent** : Standby current of the horizontal deflection amplifier.
- **H Linearity** : Horizontal linearity.
- **H Size** : Horizontal size (Max 165mm).
- **H Offset** : Horizontal position.
- **V Size** : Vertical size (Max 120mm).
- **V Offset** : Vertical position.

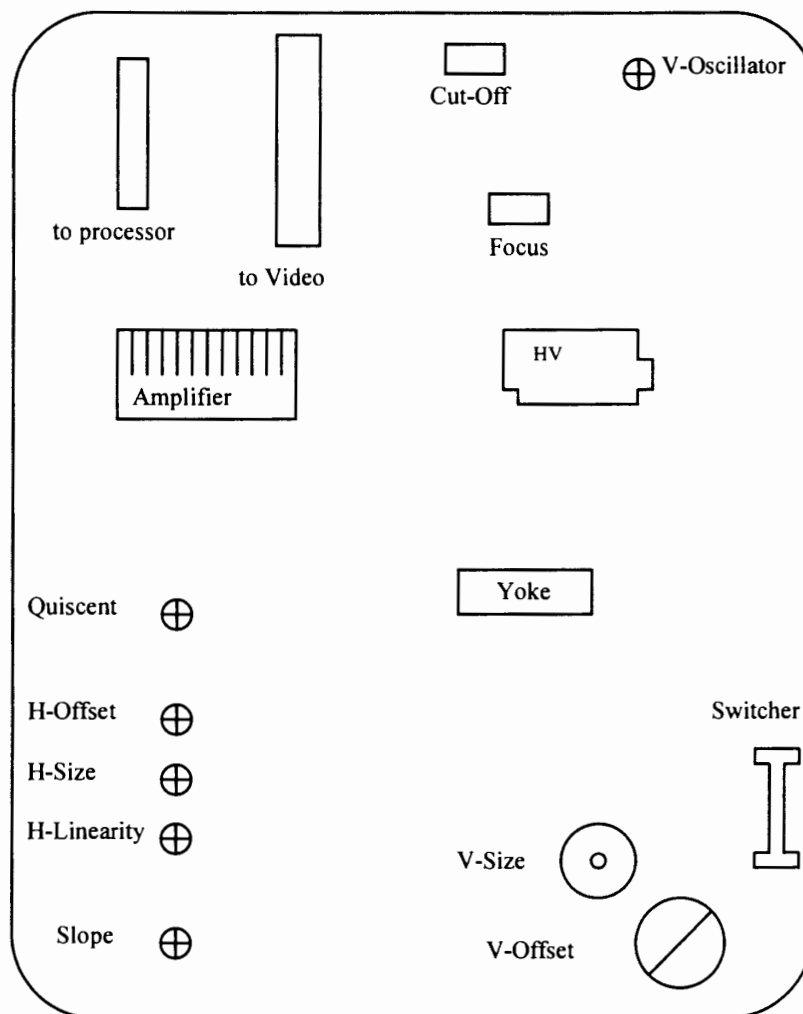

Deflection board component side

7.6.2.2 Coarse Adjustment

- Depress display button.
- Set W'form + text intensity to 0%.
- Set grid intensity to 0%
- Turn fully clockwise the intensity potentiometer on the video board.
- On the video board connect a digital multimeter on test point : W303
- Adjust threshold potentiometer to get $2\text{ V} \pm 0.1\text{ V}$ on W303.

10-Nov-94
15:49:53

1
50 μ s
50 mV

2
50 μ s
50 mV

3
50 μ s
50 mV

4
50 μ s
50 mV

50 μ s

1 50 mV 50 Ω
2 50 mV 50 Ω
3 50 mV 50 Ω
4 50 mV 50 Ω



DISPLAY SETUP

Standard
XY

Persistence
OFF On

Dot Join
OFF On

Grids
Single Dual
Quad

W'form+Text
intensity
0 %

Grid
intensity
0 %

100 MS/s

AUTO

- Set W'form intensity to 100%.
- Set grid intensity to 60%.

- Adjust H-size, H-offset, V-size, V-offset to center the image in the screen.
The vertical position should be adjusted to get the push buttons of the front panel in front of the software menus, use the utilities set up.
The small magnets mounted on the deflection yoke influence the vertical position.
- Turn the quiescent potentiometer clockwise until the default of the horizontal lines just disappears from the vertical center of the screen.
- Increase the cut off until a vertical line appears on the right side of the screen.
- Adjust the slope potentiometer to get 5mm gap between the highlighted vertical line and the right border of the selection menus.
- Adjust H-linearity to get the best linearity.

7.6.2.3 Fine Adjustment

The final adjustment of the intensity, cut off, and focus must be made in a dark room.

- Set W'form intensity to 30%.
- Set grid intensity to 0%.
- Adjust the cut off potentiometer until the highlighted vertical line disappears from the right side of the screen.
- Set W'form intensity to 20%.
- Display four traces.
- On the video board adjust the gain potentiometer (intensity) in order to get the text just readable.
- Set W'form + text intensity to 70%.
- Set grid intensity to 30%

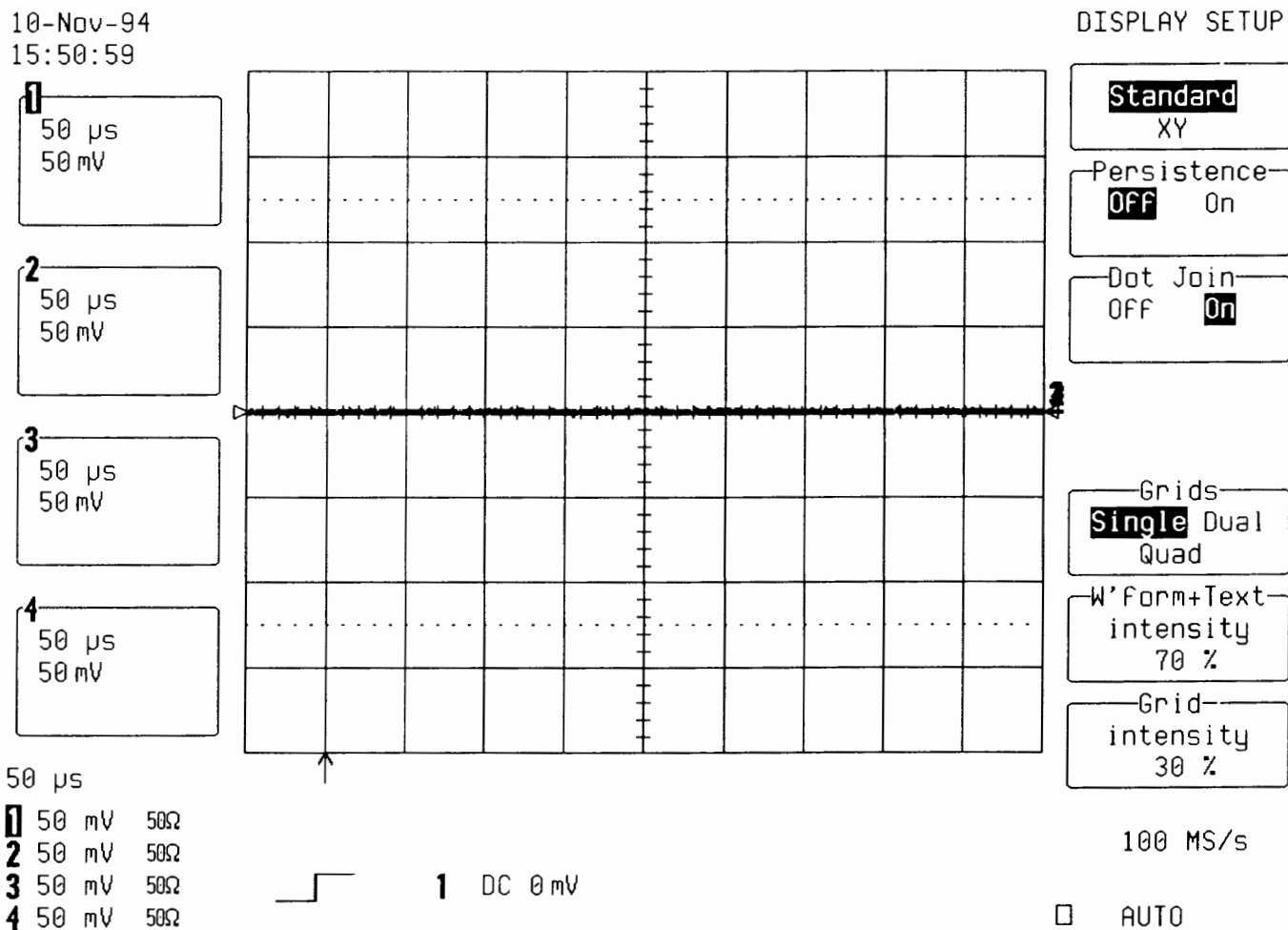

- Adjust the focus (usually fully clockwise) for most uniform focus over the entire screen.
- In a standard luminosity environment set W'form + text to 90%, and grid intensity to 60%.
- Verify the intensity, focus, and contrast adjustment, for best definition of the displayed text.

CAUTION

Never change the Vosc calibration.

7.6.3 Front End Test and Calibration Procedure

7.6.3.1 Introduction

The adjustments describe in the following calibration procedure require extension of the front panel assembly out of the scope, using two flat cables.

In order to access the front end potentiometers and variable caps located underneath the Cathode Ray tube and deflection board, dismount the front panel assembly from the scope and reconnect it to the processor board connectors J4 and J6, using the extension cable set.

Once the top cover is removed and the front panel is disassembled from the scope, extra cooling of the main board is required. It's mandatory to disconnect the existing Fan from connector J3, located on F9314A/M/L-3 card, and to use a Fan with the air flow oriented to the front end section of the board.

7.6.3.2 Power Supplies

Remove the upper shield to access the test point TP101, TP200 and JX000. Use a high precision DMM.

7.6.3.2.1 Front End Power Supply Verification

- Check on test point **TP101** the following tensions :

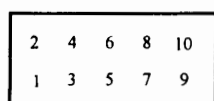

Front of DSO

- Pin 1 and Pin 2 : Ground
- + 12 VFE : pin 8 (+) = + 12 Volt \pm 2% : if problem troubleshoot regulator A100
- + 8 VFE : pin 10 (+) = + 8 Volt \pm 2% : if problem troubleshoot regulator A108
- - 12 VFE : pin 7 (-) = - 12 Volt \pm 2% : if problem troubleshoot regulator A104
- - 8 VFE : pin 9 (-) = - 8 Volt \pm 2% : if problem troubleshoot regulator A111

7.6.3.2.2 Probe Bus Power Supply Verification

- Check on test point **J1000, J2000, J3000** and **J4000** the following tensions :
- Pin 6 : Ground
- + 12 VFEP : pin 1 (+) = + 12 Volt \pm 2% : if problem troubleshoot regulator A116
- - 12 VFEP : pin 2 (-) = - 12 Volt \pm 2% : if problem troubleshoot regulator A117

7.6.3.2.3 ADC Power Supply Verification

- Check on test point TP200 the following tensions :

TP200

1	2
3	4
5	6
7	8
9	10

Front of DSO

- + 12 V : pin 5 (+) = + 12 Volt \pm 2% : if problem troubleshoot regulator A226
- + 2.5 V : pin 7 (+) = \pm 5% : if problem troubleshoot regulator A226, zener diode A200
- + 5 V : pin 3 (+) = + 5 Volt \pm 2% : if problem troubleshoot regulator A227
- - 12 V : pin 6 (-) = - 12 Volt \pm 2% : if problem troubleshoot regulator A228

7.6.3.3 16 bit DAC Verification

- Select Channel 1, Channel 2, Channel 3 and Channel 4 : Coupling DC 1 M Ω
- Enter in the internal calibration diagnostics by simultaneously depressing the third and fourth push buttons, and then by depressing the fifth.
- Select Development menu

11-Nov-94
8:42:05

1
50 ns
50 mV

2
50 ns
50 mV

3
50 ns
50 mV

4
50 ns
50 mV

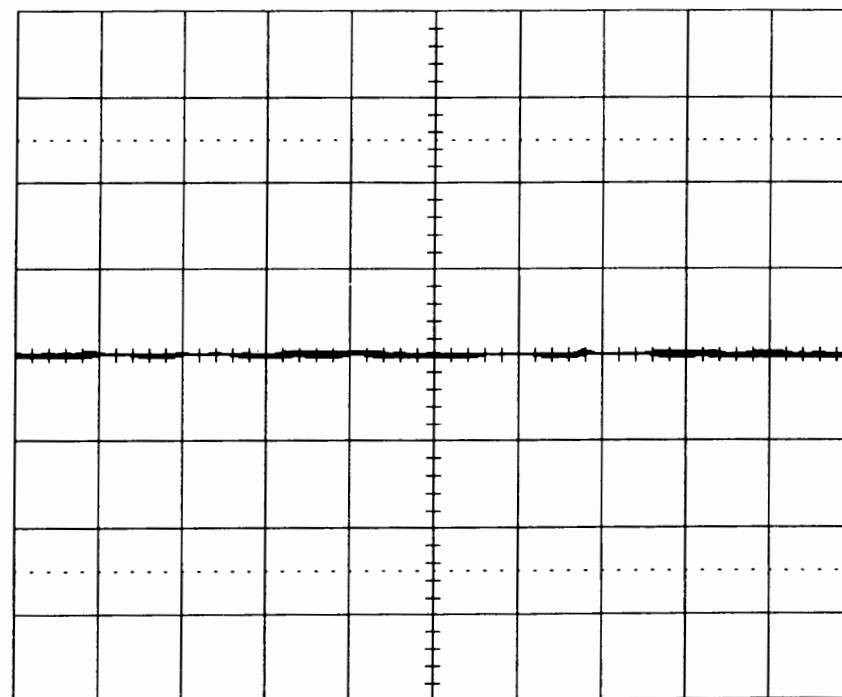

50 ns

INTERNAL

Calibration Diagnostics

Maintenance

Development

Flash Update

▪ Select Front End Control menu

11-Nov-94
8:42:22

1
50 ns
50 mV

2
50 ns
50 mV

3
50 ns
50 mV

4
50 ns
50 mV

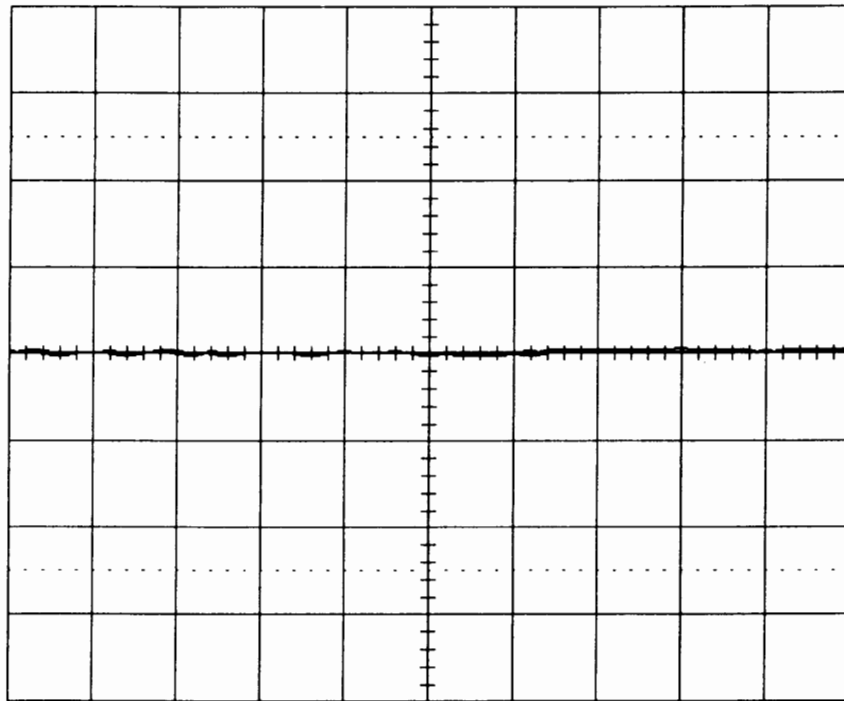

50 ns

DEVELOPMENT

- Signal Simulator
- Front End Control
- Calibration Control
- Autosetup Log
- Display Controls
- MORE ...

▪ Set Cal Level : /1 and 0,00 V

11-Nov-94
8:43:04

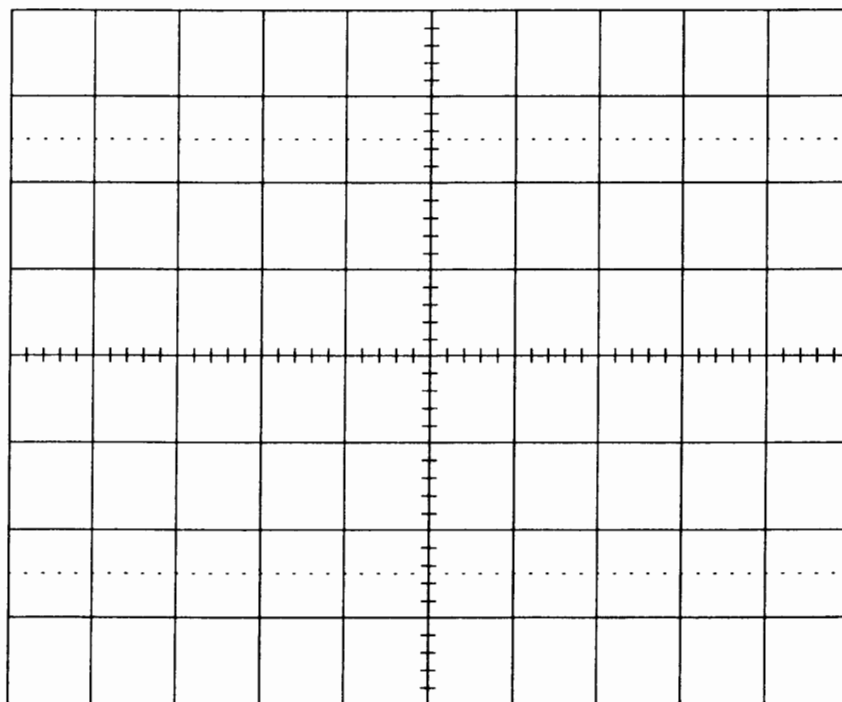

50 ns

FE CONTROL

Offset 4
0.00 V

Gain 4
0.00 V

Set to last calibrated
Gain Offset

CAL Level 4
0.00 V
-- **1** /10

▪ Check that we get on pin 9 (+) of TP100 : 0.0 mV ± 2 mV

2	4	6	8	10
1	3	5	7	9

Front of DSO

- Set Cal Level : /1 and + 4.00 V (use front panel potentiometer)

11-Nov-94
8:43:39

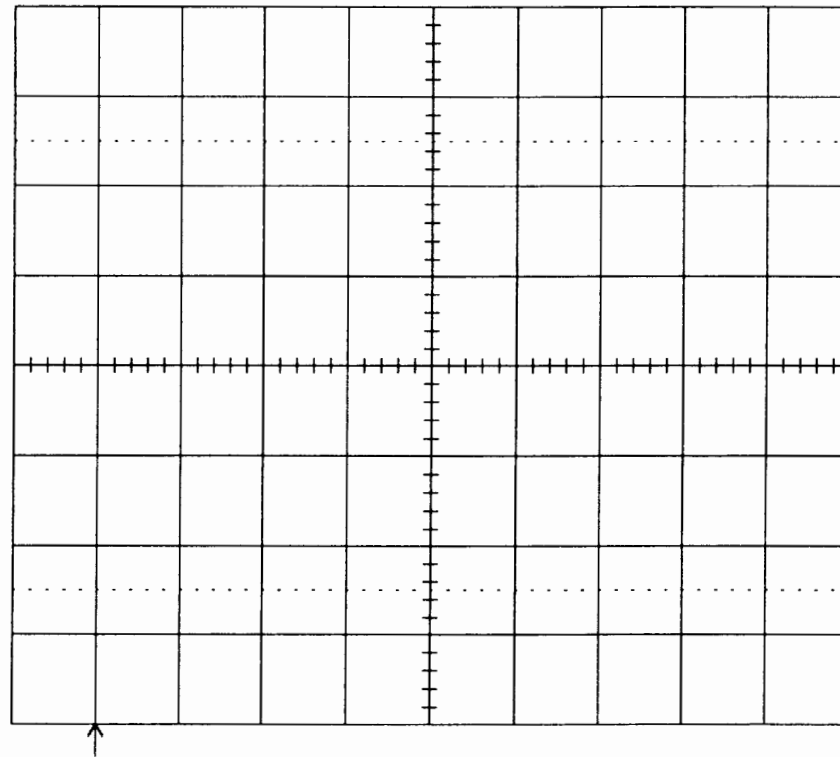

50 ns

FE CONTROL

OFFset 4
0.00 V

Gain 4
0.00 V

Set to last
calibrated
Gain OFFset

CAL Level 4
4.00 V
-- **1** /10

- Check that we get on pin 9 (+) of TP100 : 1.00 V ± 2%

- Set Cal Level : /1 and - 4.00 V (use front panel potentiometer)

11-Nov-94
8:44:06

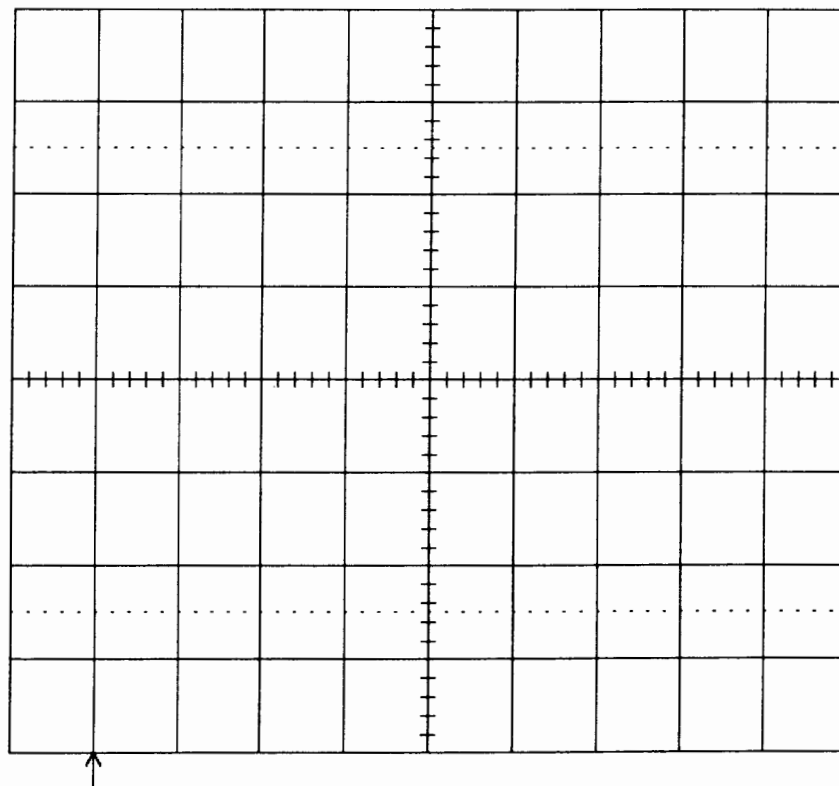

50 ns

FE CONTROL

OFFset 4
0.00 V

Gain 4
0.00 V

Set to last
calibrated
Gain OFFset

CAL Level 4
-4.00 V
-- **1** /10

Section 7 Maintenance

- Check on pin 9 (+) of TP100 that we get - 1.00 V \pm 2%
- Set Cal Level : /10 and + 10.00 V (use front panel potentiometer)

11-Nov-94
8:44:58

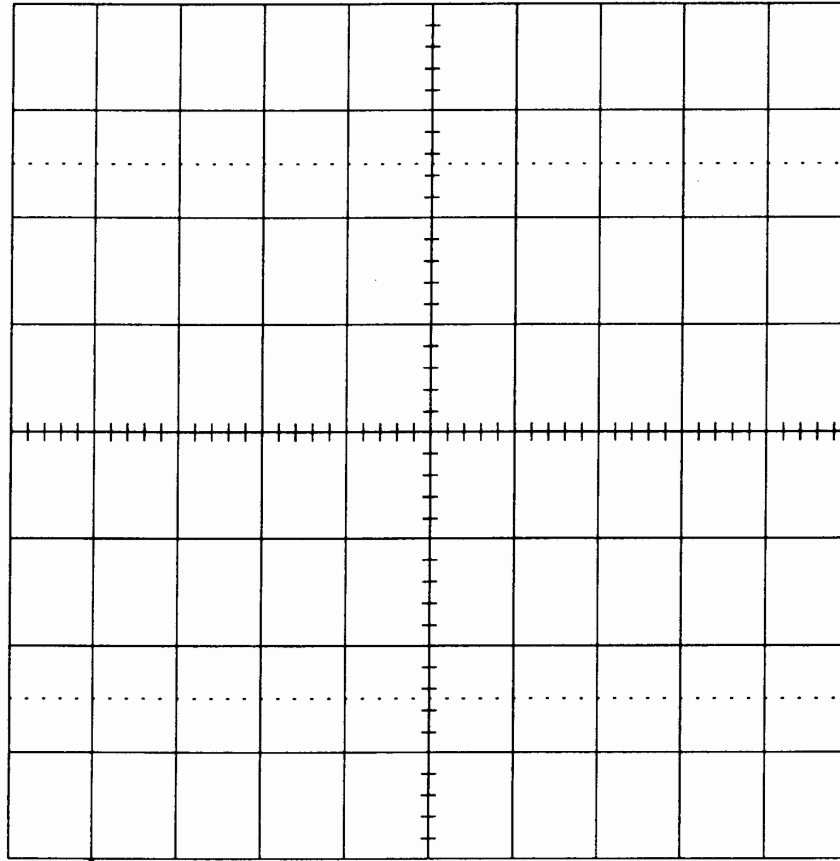

FE CONTROL

Offset 4
0.00 V

Gain 4
0.00 V

Set to last
calibrated
Gain Offset

CAL Level 4
10.00 V
-- /1 /10

100 MS/s

AUTO

50 ns

- 1 50 mV AC
- 2 50 mV AC
- 3 50 mV AC
- 4 50 mV AC

 1 AC 0 mV

- Check on pin 9 (+) of TP100 that we get + 0.25 V \pm 5%
- Set Cal Level : /10 and - 10.00 V (use front panel potentiometer)
- Check on pin 9 (+) of TP100 that we get - 0.25 V \pm 5%

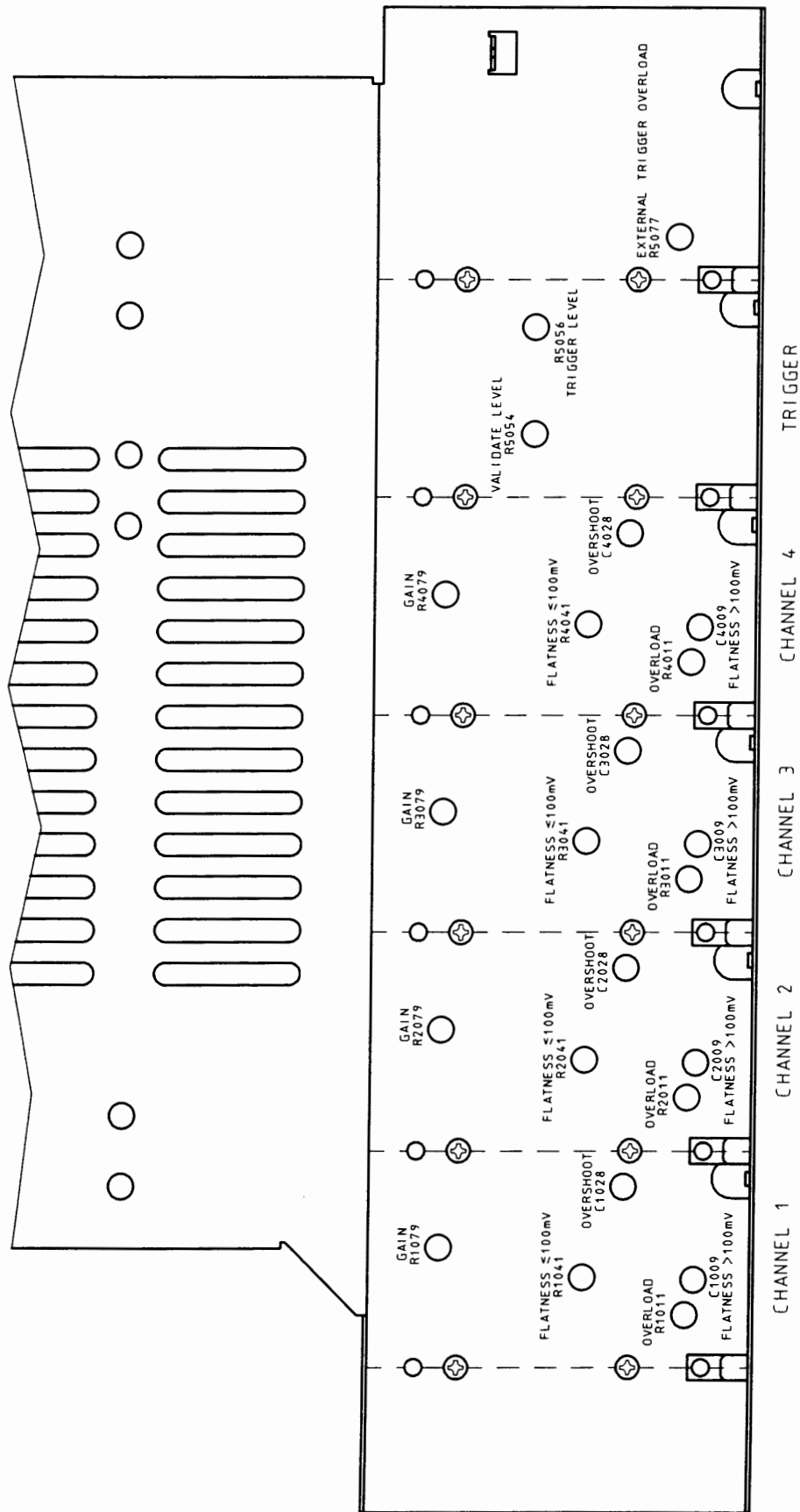

Figure 7.9 : Front End Adjustment

7.6.3.4 Input Buffer DC Gain Adjustment

7.6.3.4.1 Channel 1 DC Gain Adjustment

- In the Calibration Diagnostics select Diagnostics Results.
- Select Results for Gain, and Show Result for Channel 1
- Push Recalibrate Completely

11-Nov-94
8:46:00
28°

CALIBRATION

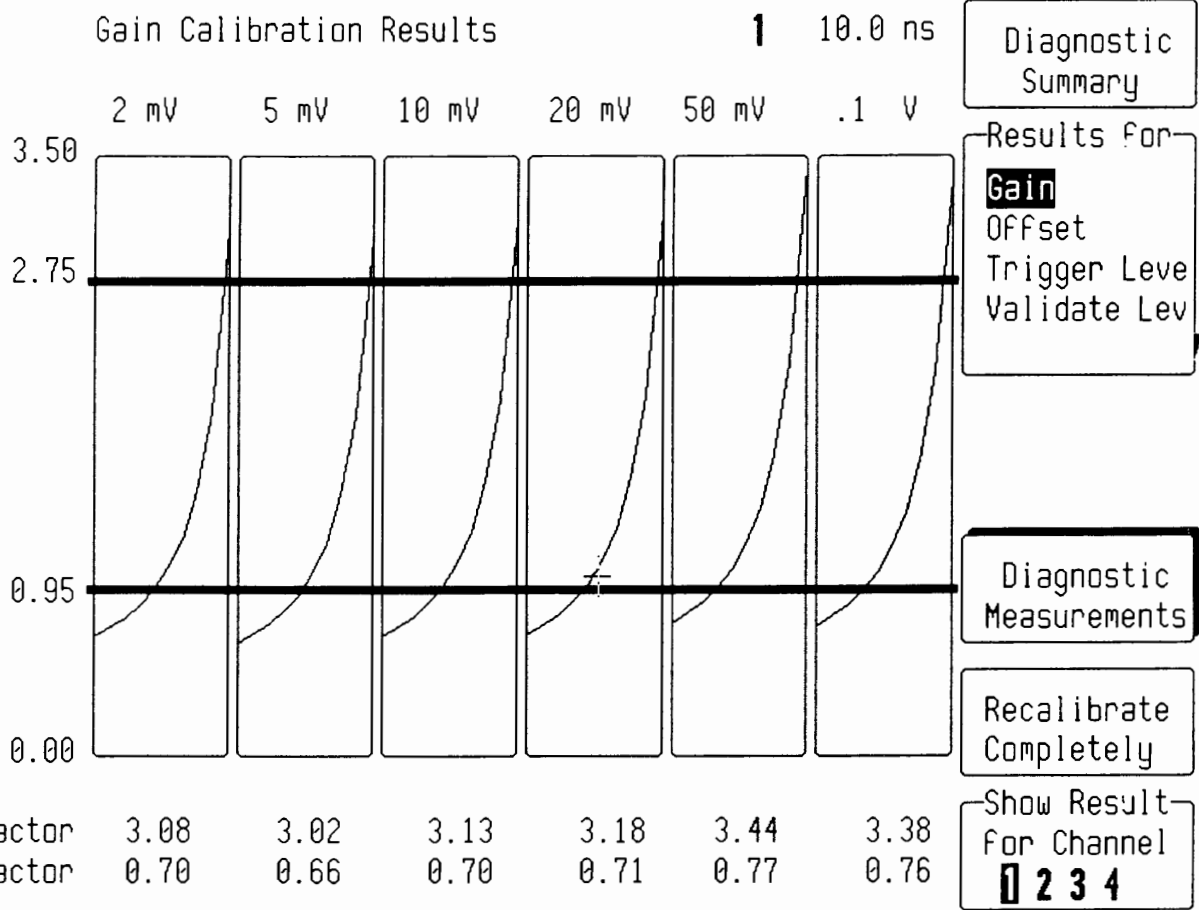

maximum factor 3.08 3.02 3.13 3.18 3.44 3.38
 minimum factor 0.70 0.66 0.70 0.71 0.77 0.76

BWL Factor 0.985 0.982 0.981 0.980 0.980 0.980

Monitor: rc 6; **1**: Δg -166, Δo 0 □

- Adjust Potentiometer R1079 to get :
 - Maximum Factor at 5 mV/div > 2.90
 - Minimum Factor at 50 mV/div < 0.85
- During the adjustment, push recalibrate completely .

7.6.3.4.2 Channel 2 DC Gain Adjustment

- In the Calibration Diagnostics select Diagnostics Results.
- Select Results for Gain, and Show Result for Channel 2
- Push Recalibrate Completely

11-Nov-94
8:46:18
28°

Gain Calibration Results

2 10.0 ns

CALIBRATION

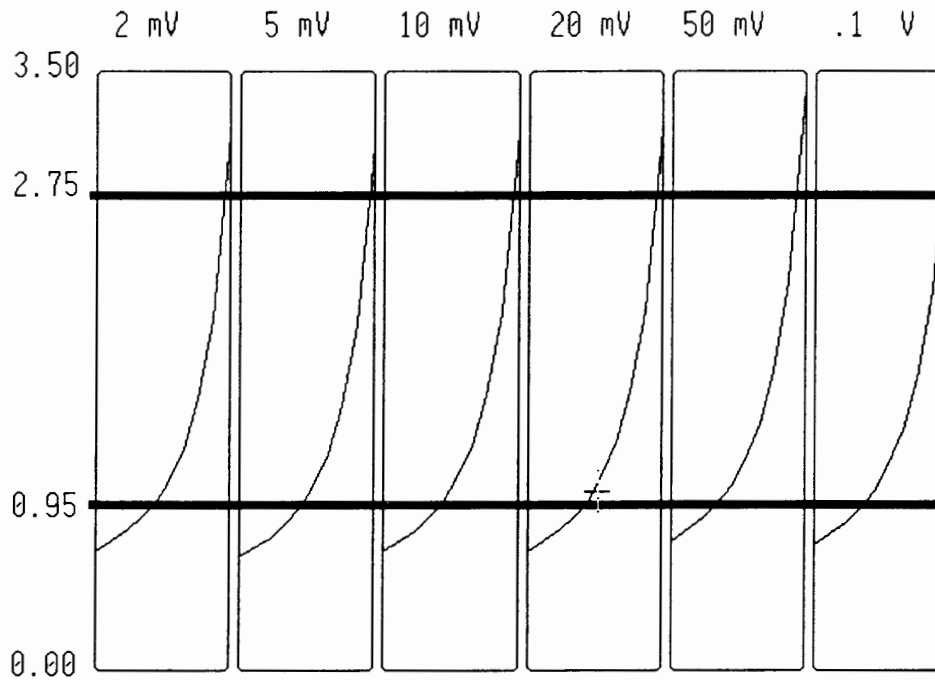

Diagnostic Summary

Results for

Gain

Offset

Trigger Level

Validate Level

Diagnostic Measurements

Recalibrate Completely

Show Result for Channel

1 2 3 4

maximum factor	3.15	3.07	3.15	3.17	3.42	3.33
minimum factor	0.70	0.67	0.70	0.70	0.76	0.74

BWL	Factor	0.988	0.980	0.980	0.980	0.980	0.980
-----	--------	-------	-------	-------	-------	-------	-------

Monitor: nc 6; **2**: Δg -143, Δ0 0

- Adjust Potentiometer R2079 to get :

Maximum Factor at 5 mV/div > 2.90

Minimum Factor at 50 mV/div < 0.85

- During the adjustment, push recalibrate completely .

7.6.3.4.3 Channel 3 DC Gain Adjustment

- In the Calibration Diagnostics select Diagnostics Results.
- Select Results for Gain, and Show Result for Channel 3
- Push Recalibrate Completely

11-Nov-94
8:46:29
28°

CALIBRATION

Gain Calibration Results

3 10.0 ns

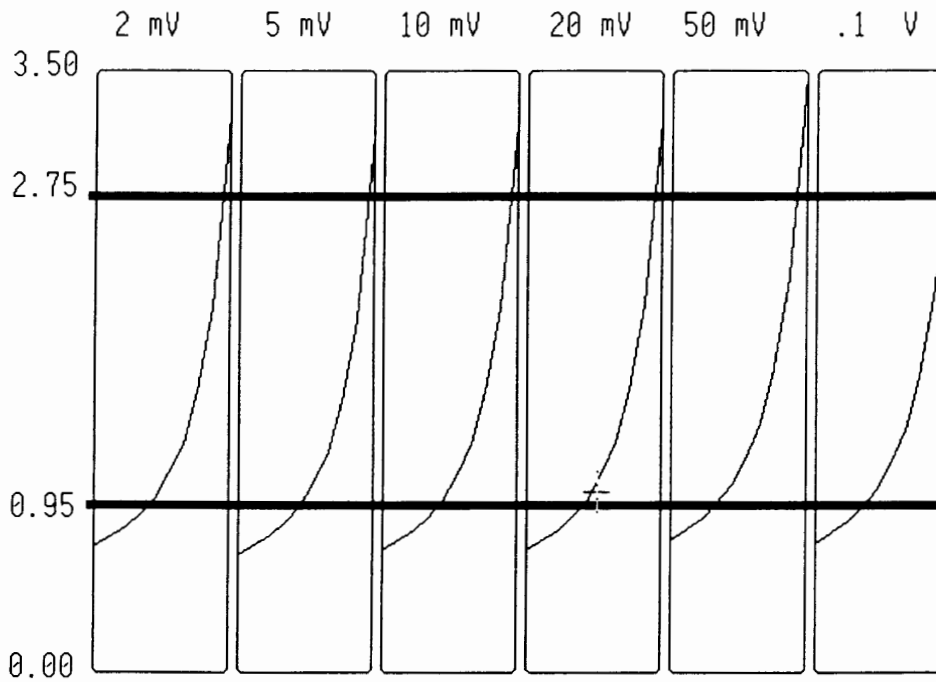

Diagnostic Summary

Results for

Gain

Offset

Trigger Level

Validate Level

Diagnostic Measurements

Recalibrate Completely

Show Result for Channel

1 2 3 4

maximum factor	3.25	3.13	3.20	3.22	3.48	3.39
minimum factor	0.72	0.68	0.71	0.71	0.77	0.75

BWL Factor	0.975	0.979	0.981	0.980	0.980	0.980
------------	-------	-------	-------	-------	-------	-------

Monitor: rc 6; **3**: Δg -63, Δ0 0 □

- Adjust Potentiometer R3079 to get :

Maximum Factor at 5 mV/div > 2.90

Minimum Factor at 50 mV/div < 0.85

- During the adjustment, push recalibrate completely .

7.6.3.4.4 Channel 4 DC Gain Adjustment

- In the Calibration Diagnostics select Diagnostics Results.
- Select Results for Gain, and Show Result for Channel 4
- Push Recalibrate Completely

21-Nov-94
17:56:21
27°

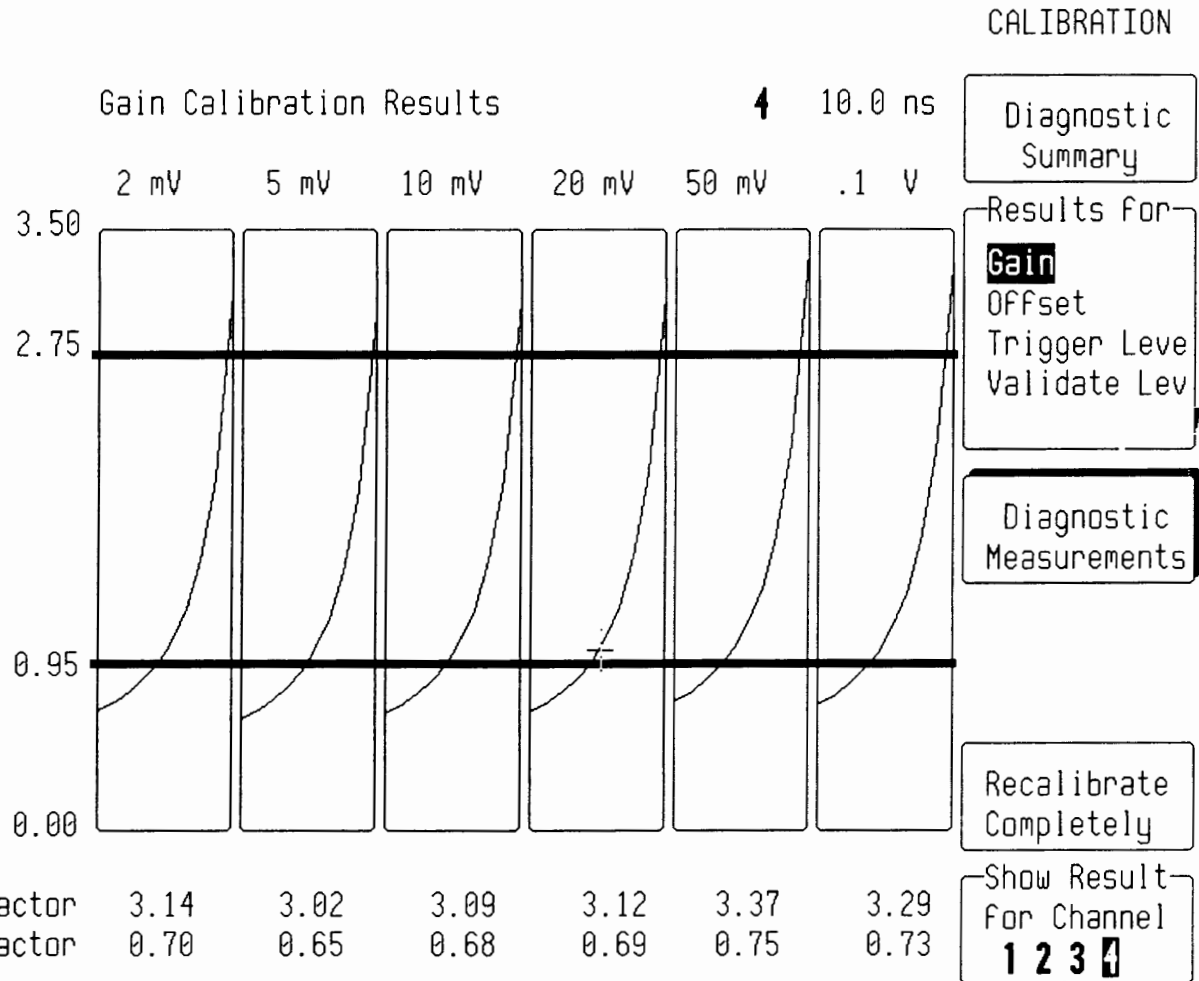

Monitor: rc 1; 4: Δg 1406, Δ0 0

- Adjust Potentiometer R4079 to get :
 - Maximum Factor at 5 mV/div > 2.90
 - Minimum Factor at 50 mV/div < 0.85
- During the adjustment, push recalibrate completely .

7.6.3.5 Overshoot and Risetime Adjustment

7.6.3.5.1 Channel 1 Overshoot and Risetime Adjustment

- Apply the fast rise time pulse generator LeCroy 4969 or equivalent (< 600 psec) to Channel 1.

- Turn on trace : Ch1
- Display setup : Standard, Persistence off, Dot join on, Single grid
- Coupling Channel 1 : DC 50 Ω
- V/div. offset : Normal
- Global BWL : Off
- Probe atten : X1
- Input offset : - 250 mV
- Input gain : 100 mV/div
- Trigger setup : Edge
- Trigger on : 1
- Trigger level : DC 250 mV
- Coupling 1 : DC
- Slope 1 : Pos
- Mode : Normal
- Holdoff : Off
- Timebase : 2 nsec/div
- Record up to : 50K samples
- Delay : 50 % Pre-Trigger
- Turn on trace : A
- Select Math Setup
- For Math : Use at most 1000 points
- Redefine A
- Use Math ? : Yes
- Math Type : Average
- Avg Type : Summed
- Of : Channel 1
- Turn off trace : Channel 1
- Cursors/Measure : Parameters
- Mode : Custom
- Statistics : on
- Change Parameters :
- on displayed trace : A
- On line 1 :
- Measure : Over + of A
- On line 2 :
- Measure : Rise of A

- Adjust C1028 to get Over + (A) = 3.5 % (minimum 2.5 %, maximum 5.5 %)

- Check that rise time is less than 1.1 nsec

11-Nov-94
22:18:56

A: Average(1)
2 ns
100 mV
208 swps

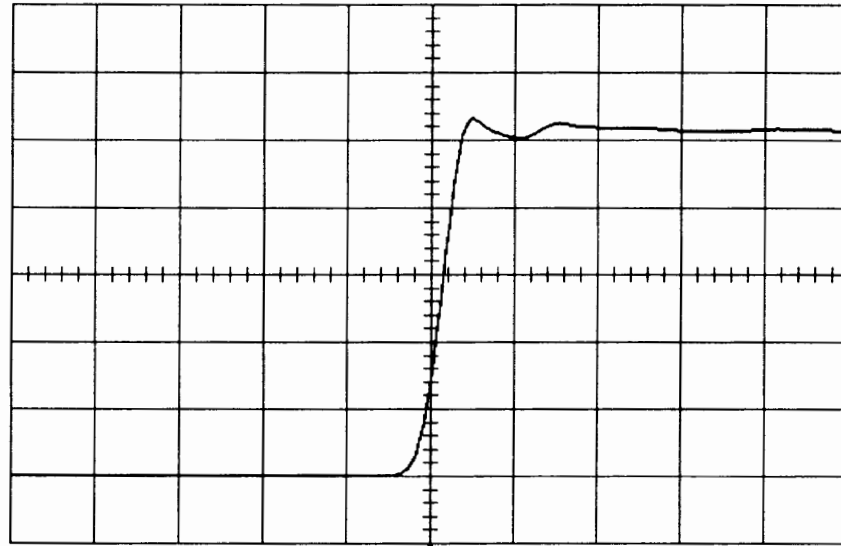

135 sweeps:	average	low	high	sigma
over+(A)	3.6 %	3.6	4.0	0.0
rise(A)	0.87 ns	0.85	0.87	0.00

SETUP OF **A**

use Math?
No **Yes**

Math Type
Arithmetic
Average
Enh.Res
Extrema
FFT

Avg Type
Summed
Continuous

For
1000
(sweeps)

of
1 2 3 4 B C D
M1 M2 M3 M4

2 ns RIS

- 1** .1 V 50Ω
- 2** .1 V 50Ω
- 3** .1 V 50Ω
- 4** .1 V 50Ω

A: Average(1) 200 points

AUTO
10 Gs/s

11-Nov-94
22:18:40

A: Average(1)
2 ns
100 mV
158 swps

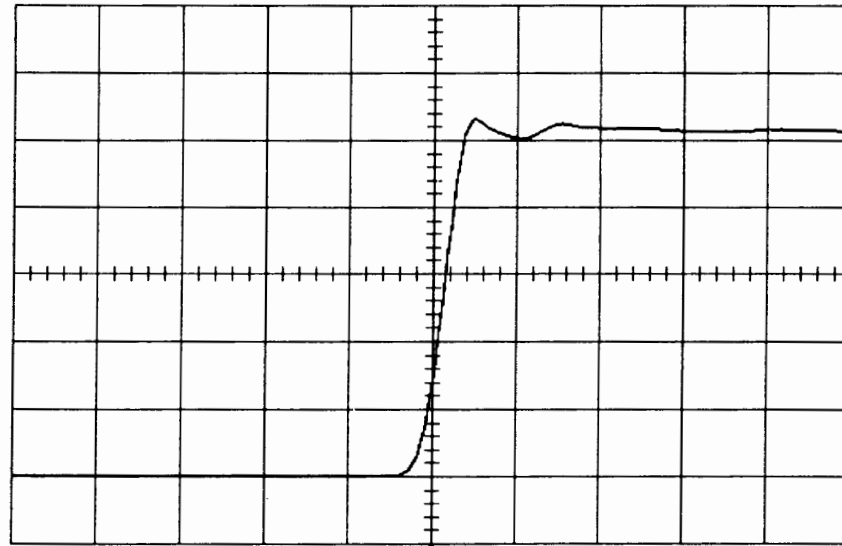

102 sweeps:	average	low	high	sigma
over+(A)	3.6 %	3.6	4.0	0.0
rise(A)	0.87 ns	0.85	0.87	0.00

CHANGE PARAM

On line
1 2 3 4 5

DELETE ALL
PARAMETERS

measure
median
minimum
over+
over-
period

of
1 2 3 4
A B C D

2 ns RIS

- 1** .1 V 50Ω
- 2** .1 V 50Ω
- 3** .1 V 50Ω
- 4** .1 V 50Ω

1 DC 250 mV

AUTO
10 Gs/s

7.6.3.5.2 Channel 2 Overshoot and Risetime Adjustment

- Apply the fast rise time pulse generator LeCroy 4969 or equivalent (< 600 psec) to Channel 2.

- Turn on trace : Ch2
- Display setup : Standard, Persistence off, Dot join on, Single grid
- Coupling Channel 2 : DC 50 Ω
- V/div. offset : Normal
- Global BWL : Off
- Probe atten : X1
- Input offset : - 250 mV
- Input gain : 100 mV/div
- Trigger setup : Edge
- Trigger on : 2
- Trigger level : DC 250 mV
- Coupling 2 : DC
- Slope 2 : Pos
- Mode : Normal
- Holdoff : Off
- Timebase : 2 nsec/div
- Record up to : 50K samples
- Delay : 50 % Pre-Trigger
- Turn on trace : B

- Select Math Setup
- For Math : Use at most 1000 points
- Redefine B
- Use Math ? : Yes
- Math Type : Average
- Avg Type : Summed
- Of : Channel 2
- Turn off trace : Channel 2

- Cursors/Measure : Parameters
- Mode : Custom
- Statistics : On
- Change Parameters :
- On displayed trace : B
- On line 1 :
- Measure : Over + of B
- On line 2 :
- Measure : Rise of B

- Adjust C2028 to get $\text{Over + (B)} = 3.5 \%$ (minimum 2.5 %, maximum 5.5 %)

- Check that rise time is less than 1.1 nsec

11-Nov-94
22:22:05

B: Average(2)
2 ns
100 mV
66 swps

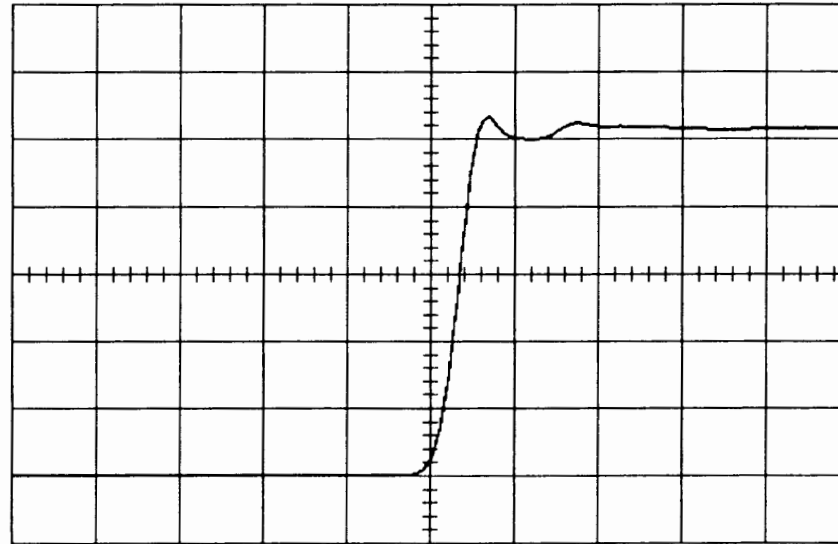

	52 sweeps:	average	low	high	sigma
over+(B)		3.6 %	3.3	3.6	0.1
rise(B)		0.84 ns	0.83	0.86	0.00

SETUP OF **B**

use Math?
No **Yes**

Math Type
Arithmetic
Average
Enh.Res
Extrema
FFT

Avg Type
Summed
Continuous

for
1000
(sweeps)

of
1 2 3 4 A C D
M1 M2 M3 M4

2 ns RIS

- 1** .1 V 50Ω
- 2** .1 V 50Ω
- 3** .1 V 50Ω
- 4** .1 V 50Ω

B: Average(2) 200 points

AUTO
10 Gs/s

11-Nov-94
22:22:24

B: Average(2)
2 ns
100 mV
126 swps

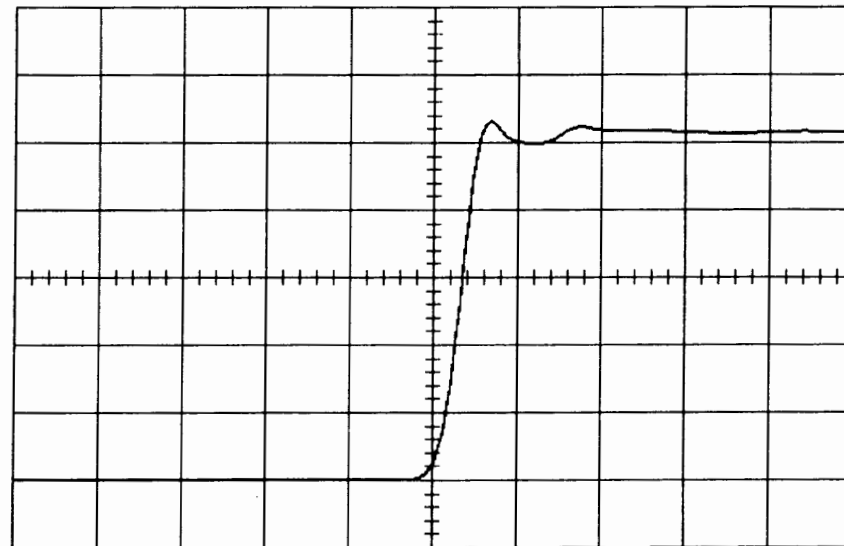

	39 sweeps:	average	low	high	sigma
over+(B)		3.6 %	3.5	3.6	0.0
rise(B)		0.83 ns	0.83	0.83	0.00

CHANGE PARAM

On line
1 2 3 4 5

DELETE ALL
PARAMETERS

measure
median
minimum
over+
over-
period

of
1 2 3 4
A B C D

2 ns RIS

- 1** .1 V 50Ω
- 2** .1 V 50Ω
- 3** .1 V 50Ω
- 4** .1 V 50Ω

2 DC 250 mV

AUTO
10 Gs/s

7.6.3.5.3 Channel 3 Overshoot and Risetime Adjustment

- Apply the fast rise time pulse generator LeCroy 4969 or equivalent (< 600 psec) to Channel 3.

- Turn on trace : Ch3
- Display setup : Standard, Persistence off, Dot join on, Single grid
- Coupling Channel 3 : DC 50 Ω
- V/div. offset : Normal
- Global BWL : Off
- Probe atten : X1
- Input offset : - 250 mV
- Input gain : 100 mV/div
- Trigger setup : Edge
- Trigger on : 3
- Trigger level : DC 250 mV
- Coupling 3 : DC
- Slope 3 : Pos
- Mode : Normal
- Holdoff : Off
- Timebase : 2 nsec/div
- Record up to : 50K samples
- Delay : 50 % Pre-Trigger
- Turn on trace : C

- Select Math Setup
- For Math : Use at most 1000 points
- Redefine C
- Use Math ? : Yes
- Math Type : Average
- Avg Type : Summed
- Of : Channel 3
- Turn off trace : Channel 3

- Cursors/Measure : Parameters
- Mode : Custom
- Statistics : On
- Change Parameters :
- On displayed trace : C
- On line 1 :
- Measure : Over + of C
- On line 2 :
- Measure : Rise of C

- Adjust C3028 to get Over + (C) = 3.5 % (minimum 2 %, maximum 5.5 %)

- Check that rise time is less than 1.1 nsec

11-Nov-94
22:26:57

C: Average(3)
2 ns
100 mV
39 swps

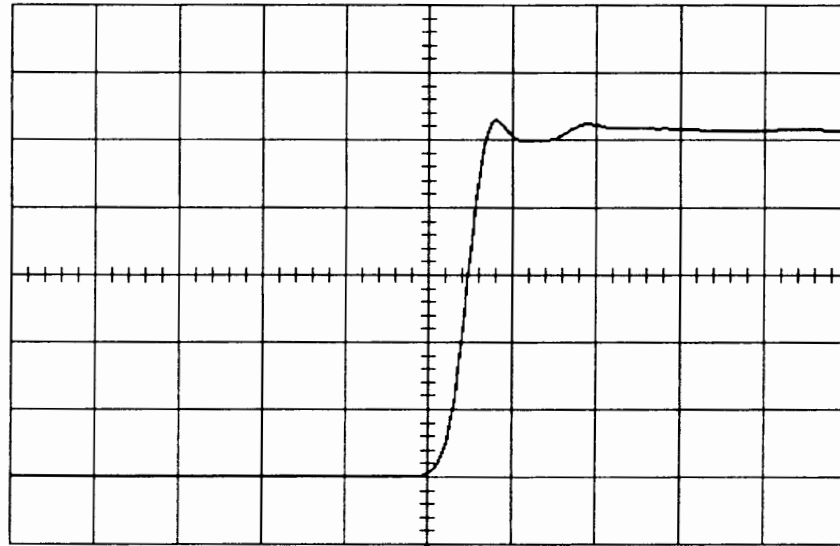

	30 sweeps:	average	low	high	sigma
over+(C)		3.4 %	3.3	3.7	0.1
rise(C)		0.82 ns	0.81	0.82	0.00

SETUP OF **C**

use Math?
No **Yes**

Math Type
Arithmetic
Average
Enh.Res
Extrema
FFT

Avg Type
Summed
Continuous

for
1000
(sweeps)

of
1 2 3 4 A B D
M1 M2 M3 M4

2 ns RIS

- 1** .1 V 50Ω
- 2** .1 V 50Ω
- 3** .1 V 50Ω
- 4** .1 V 50Ω

C: Average(3) 200 points

AUTO
10 Gs/s

11-Nov-94
22:28:03

C: Average(3)
2 ns
100 mV
22 swps

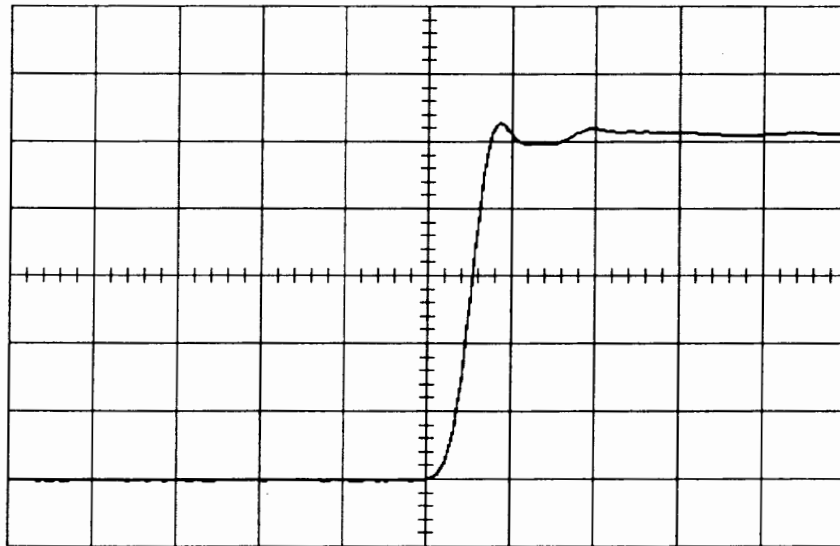

	19 sweeps:	average	low	high	sigma
over+(C)		3.5 %	3.0	3.6	0.2
rise(C)		0.82 ns	0.81	0.83	0.00

CHANGE PARAM

On line
1 2 3 4 5

DELETE ALL
PARAMETERS

measure
median
minimum
over+
over-
period

of
1 2 3 4
A B C D

2 ns RIS

- 1** .1 V 50Ω
- 2** .1 V 50Ω
- 3** .1 V 50Ω
- 4** .1 V 50Ω

3 DC 250 mV

AUTO
10 Gs/s

7.6.3.5.4 Channel 4 Overshoot and Risetime Adjustment

- Apply the fast rise time pulse generator LeCroy 4969 or equivalent (< 600 psec) to Channel 4.

- Turn on trace : Ch4
- Display setup : Standard, Persistence off, Dot join on, Single grid
- Coupling Channel 4 : DC 50 Ω
- V/div. offset : Normal
- Global BWL : Off
- Probe atten : X1
- Input offset : - 250 mV
- Input gain : 100 mV/div
- Trigger setup : Edge
- Trigger on : 4
- Trigger level : DC 250 mV
- Coupling 4 : DC
- Slope 4 : Pos
- Mode : Normal
- Holdoff : Off
- Timebase : 2 nsec/div
- Record up to : 50K samples
- Delay : 50 % Pre-Trigger
- Turn on trace : D

- Select Math Setup
- For Math : Use at most 1000 points
- Redefine D
- Use Math ? : Yes
- Math Type : Average
- Avg Type : Summed
- Of : Channel 4
- Turn off trace : Channel 4

- Cursors/Measure : Parameters
- Mode : Custom
- Statistics : On
- Change Parameters :
- On displayed trace : D
- On line 1 :
- Measure : Over + of D
- On line 2 :
- Measure : Rise of D

- Adjust C4028 to get Over + (D) = 3.5 % (minimum 2 %, maximum 5.5 %)

- Check that rise time is less than 1.1 nsec

14-Nov-94
16:20:02

0: Average(4)
2 ns
100 mV
407 swps

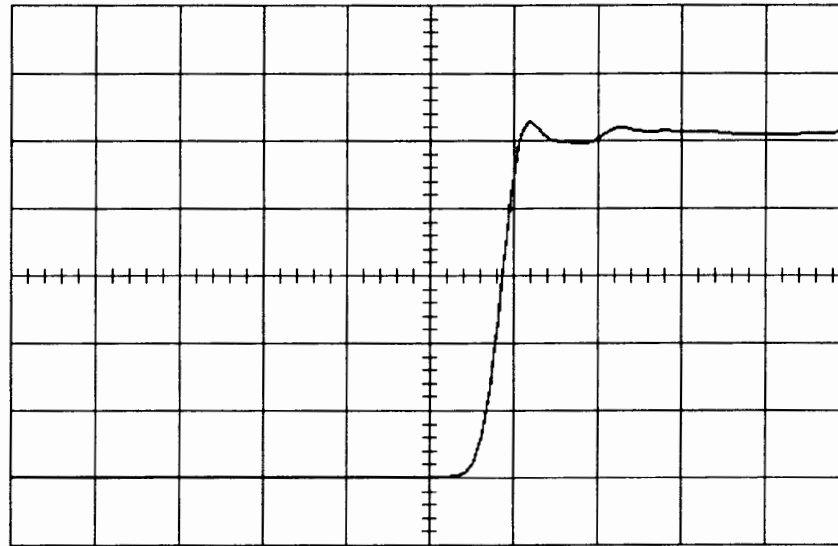

313 sweeps:	average	low	high	sigma
over+(0)	3.6 %	3.5	4.1	0.1
rise(0)	0.84 ns	0.80	0.84	0.00

SETUP OF **0**

use Math?
No **Yes**

Math Type
Arithmetic
Average
Enh.Res
Extrema
FFT

Avg Type
Summed
Continuous

For
1000
(sweeps)

of
1 2 3 4 A B C
M1 M2 M3 M4

2 ns RIS

- 1** .1 V 50Ω
- 2** .1 V 50Ω
- 3** .1 V 50Ω
- 4** .1 V 50Ω

0: Average(4) 200 points

AUTO
10 Gs/s

14-Nov-94
16:19:45

0: Average(4)
2 ns
100 mV
370 swps

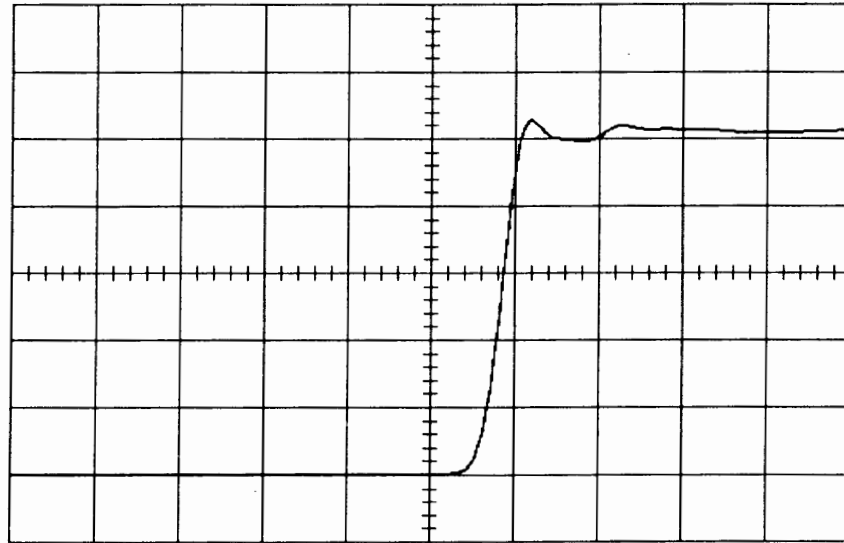

279 sweeps:	average	low	high	sigma
over+(0)	3.6 %	3.5	4.1	0.1
rise(0)	0.84 ns	0.80	0.84	0.00

CHANGE PARAM

On line
1 2 3 4 5

DELETE ALL
PARAMETERS

measure
median
minimum
over+
over-
period

of
1 2 3 4
A B C 0

2 ns RIS

- 1** .1 V 50Ω
- 2** .1 V 50Ω
- 3** .1 V 50Ω
- 4** .1 V 50Ω

4 DC 250 mV

AUTO
10 Gs/s

7.6.3.6 Flatness Adjustment

7.6.3.6.1 Channel 1 HF Adjustment

- Apply the fast rise time pulse generator LeCroy 4969 or equivalent (< 600 psec) to Channel 1. Set pulser to 62.5 msec low frequency.

- Turn on trace : Ch1
- Display setup : Standard, Persistence off, Dot join on, Single grid
- Coupling Channel 1 : DC 50 Ω
- V/div. offset : Normal
- Global BWL : Off
- Probe atten : X1
- Input offset : - 250 mV
- Input gain : 100 mV/div

- Trigger setup : Edge
- Trigger on : 1
- Trigger level : DC 250 mV
- Coupling 1 : DC
- Slope 1 : Pos
- Mode : Normal
- Holdoff : Off

- Timebase : 20 μ sec/div
- Record up to : 50K samples
- Delay : 10 % Pre-Trigger

- Turn on trace : A
- Select Math Setup
- For Math : Use at most 1000 points
- Redefine A
- Use Math ? : Yes
- Math Type : Average
- Avg Type : Summed
- Of : Channel 1

- With the vertical Zoom set A to 10 mV

- Adjust pot R1041 to get a flat square wave.

- Set Input gain : 200 mV/div
- Coupling Channel 1 : DC 1 M Ω

- Adjust cap C1009 to get a flat square wave.

14-Nov-94
16:53:37

1 20 μ s
100 mV

A: Average(1)
20 μ s
10.0 mV
1000 swps

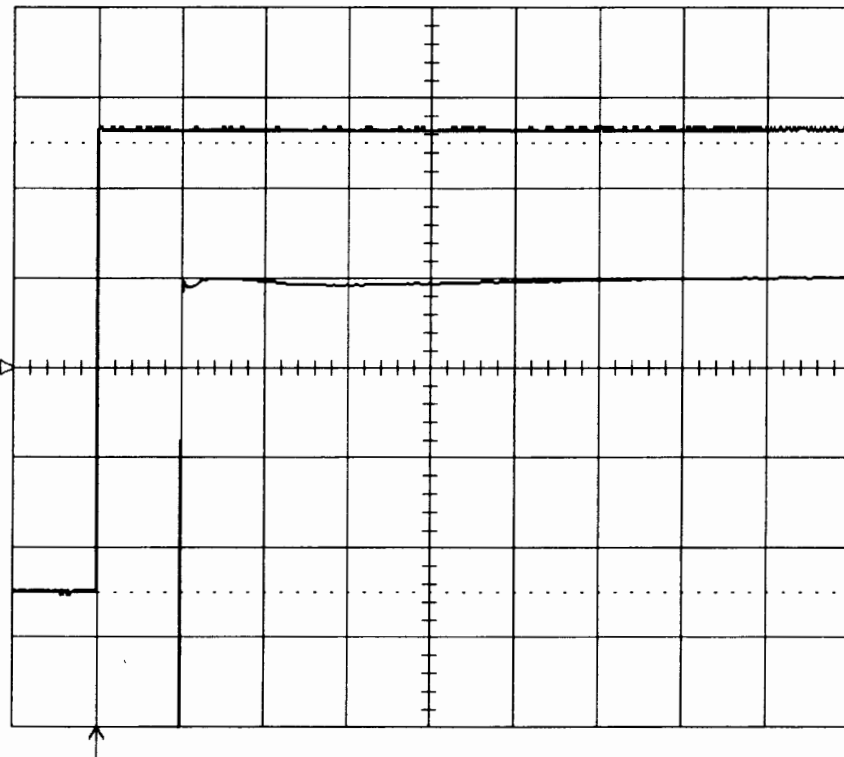

SETUP OF **A**

use Math?
No **Yes**

Math Type
Arithmetic
Average
Enh.Res
Extrema
FFT

Avg Type
Summed
Continuous

For
1000
(sweeps)

of
1 2 3 4 B C D
M1 M2 M3 M4

20 μ s

- 1** .1 V 50 Ω
- 2** .1 V 50 Ω
- 3** .1 V 50 Ω
- 4** .1 V 50 Ω

A: Average(1) 20000 -> 1000 points

AUTO
100 Ms/s

11-Nov-94
9:17:49

1 20 μ s
200 mV

A: Average(1)
20 μ s
20.0 mV
240 swps

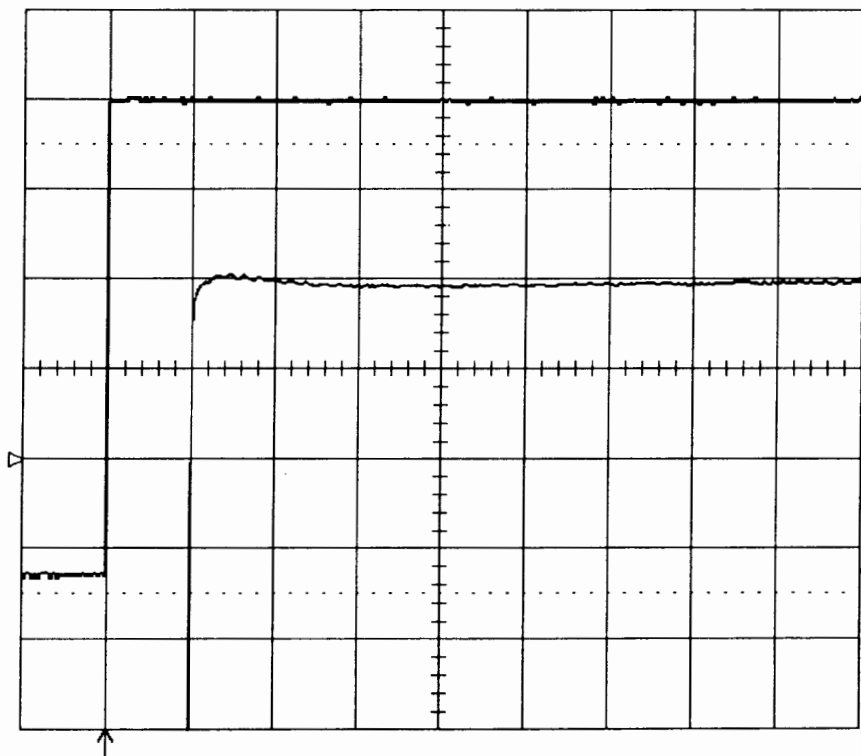

CHANNEL 1

Coupling
DC50 Ω
Grounded
DC1M Ω
Grounded
AC1M Ω

V/div Offset
NORMAL
ECL TTL

Global BWL
OFF On
(30 MHz)

Probe Atten
x1
x2
x5
x10
x20

20 μ s

- 1** .2 V DC
- 2** .1 V 50 Ω
- 3** .1 V 50 Ω
- 4** .1 V 50 Ω

1 DC 0.248 V

100 MS/s

NORMAL

7.6.3.6.2 Channel 2 HF Adjustment

- Apply the fast rise time pulse generator LeCroy 4969 or equivalent (< 600 psec) to Channel 2. Set pulser to 62.5 msec low frequency.

- Turn on trace : Ch2
- Display setup : Standard, Persistence off, Dot join on, Single grid
- Coupling Channel 2 : DC 50 Ω
- V/div. offset : Normal
- Global BWL : Off
- Probe atten : X1
- Input offset : - 250 mV
- Input gain : 100 mV/div

- Trigger setup : Edge
- Trigger on : 2
- Trigger level : DC 250 mV
- Coupling 2 : DC
- Slope 2 : Pos
- Mode : Normal
- Holdoff : Off

- Timebase : 20 μ sec/div
- Record up to : 50K samples
- Delay : 10 % Pre-Trigger

- Turn on trace : B
- Select Math Setup
- For Math : Use at most 1000 points
- Redefine B
- Use Math ? : Yes
- Math Type : Average
- Avg Type : Summed
- Of : Channel 2

- With the vertical Zoom set B to 10 mV

- Adjust pot R2041 to get a flat square wave.

- Set Input gain : 200 mV/div
- Coupling Channel 2 : DC 1 M Ω

- Adjust cap C2009 to get a flat square wave.

14-Nov-94
16:58:12

2
20 μ s
100 mV

B: Average(2)
20 μ s
10.0 mV
88 swps

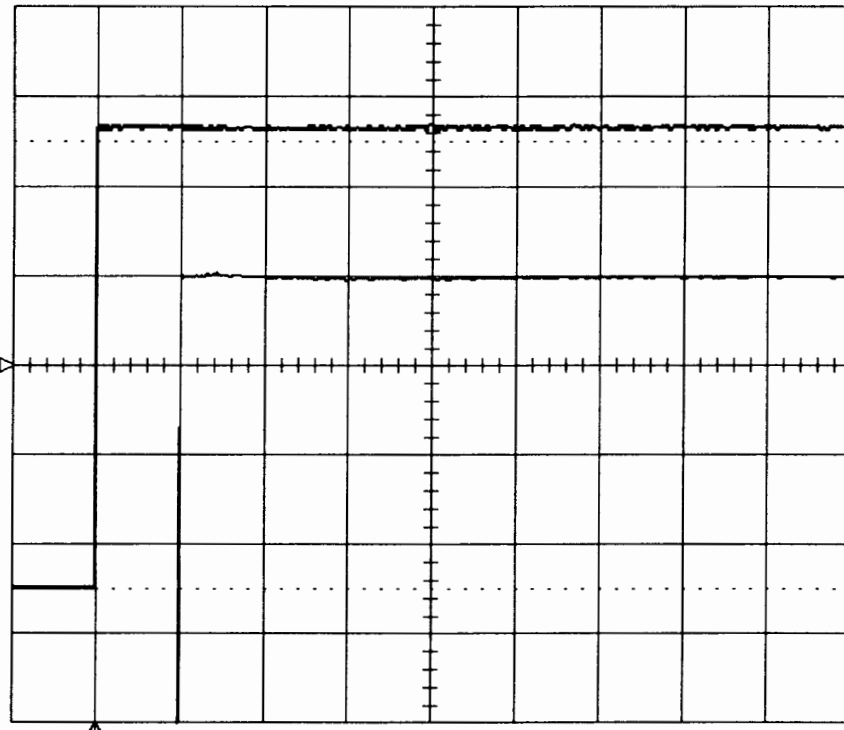

SETUP OF **B**

use Math?
No **Yes**

Math Type
Arithmetic
Average
Enh. Res
Extrema
FFT

Avg Type
Summed
Continuous

for
1000
(sweeps)

of
1 2 3 4 A C D
M1 M2 M3 M4

20 μ s

- 1** .1 V 50 Ω
- 2** .1 V 50 Ω
- 3** .1 V 50 Ω
- 4** .1 V 50 Ω

B: Average(2)
20000 -> 1000 points

NORMAL
100 Ms/s

14-Nov-94
17:00:05

2
20 μ s
200 mV

B: Average(2)
20 μ s
20.0 mV
132 swps

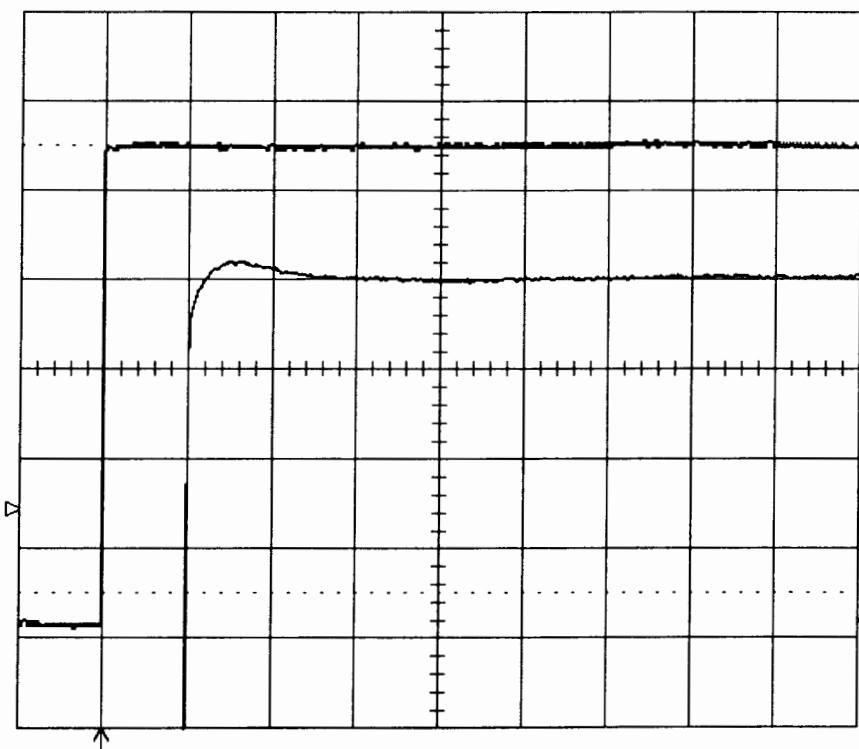

CHANNEL **2**

Coupling
DC50 Ω
Grounded
DC1M Ω
Grounded
AC1M Ω

V/div Offset
NORMAL
ECL TTL

Global BWL
OFF On
(30 MHz)

20 μ s

- 1** .1 V 50 Ω
- 2** .2 V DC
- 3** .1 V 50 Ω
- 4** .1 V 50 Ω

2 DC 0.248 V

Probe Atten
x1
x2
x5
x10
x20

NORMAL
100 Ms/s

7.6.3.6.3 Channel 3 HF Adjustment

- Apply the fast rise time pulse generator LeCroy 4969 or equivalent (< 600 psec) to Channel 3. Set pulser to 62.5 msec low frequency.

- Turn on trace : Ch3
- Display setup : Standard, Persistence off, Dot join on, Single grid
- Coupling Channel 3 : DC 50 Ω
- V/div. offset : Normal
- Global BWL : Off
- Probe atten : X1
- Input offset : - 250 mV
- Input gain : 100 mV/div

- Trigger setup : Edge
- Trigger on : 3
- Trigger level : DC 250 mV
- Coupling 3 : DC
- Slope 3 : Pos
- Mode : Normal
- Holdoff : Off

- Timebase : 20 μ sec/div
- Record up to : 50K samples
- Delay : 10 % Pre-Trigger

- Turn on trace : C
- Select Math Setup
- For Math : Use at most 1000 points
- Redefine C
- Use Math ? : Yes
- Math Type : Average
- Avg Type : Summed
- Of : Channel 3

- With the vertical Zoom set C to 10 mV

- Adjust pot R3041 to get a flat square wave.

- Set Input gain : 200 mV/div
- Coupling Channel 3 : DC 1 M Ω

- Adjust cap C3009 to get a flat square wave.

14-Nov-94
17:02:16

3
20 μ s
100 mV

C: Average(3)
20 μ s
10.0 mV
100 swps

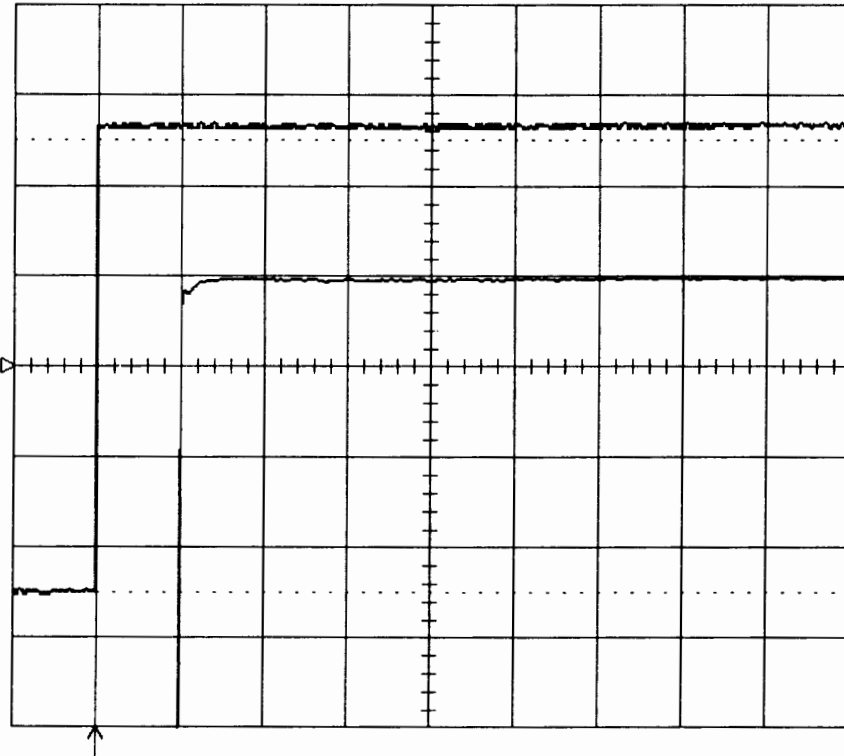

SETUP OF **C**

use Math?
No **Yes**

Math Type
Arithmetic
Average
Enh.Res
Extrema
FFT

Avg Type
Summed
Continuous

For
1000
(sweeps)

of
1 2 3 4 A B D
M1 M2 M3 M4

20 μ s

- 1** .1 V 50 Ω
- 2** .1 V 50 Ω
- 3** .1 V 50 Ω
- 4** .1 V 50 Ω

C: Average(3) 20000 -> 1000 points

NORMAL
100 Ms/s

14-Nov-94
17:02:58

3
20 μ s
200 mV

C: Average(3)
20 μ s
20.0 mV
155 swps

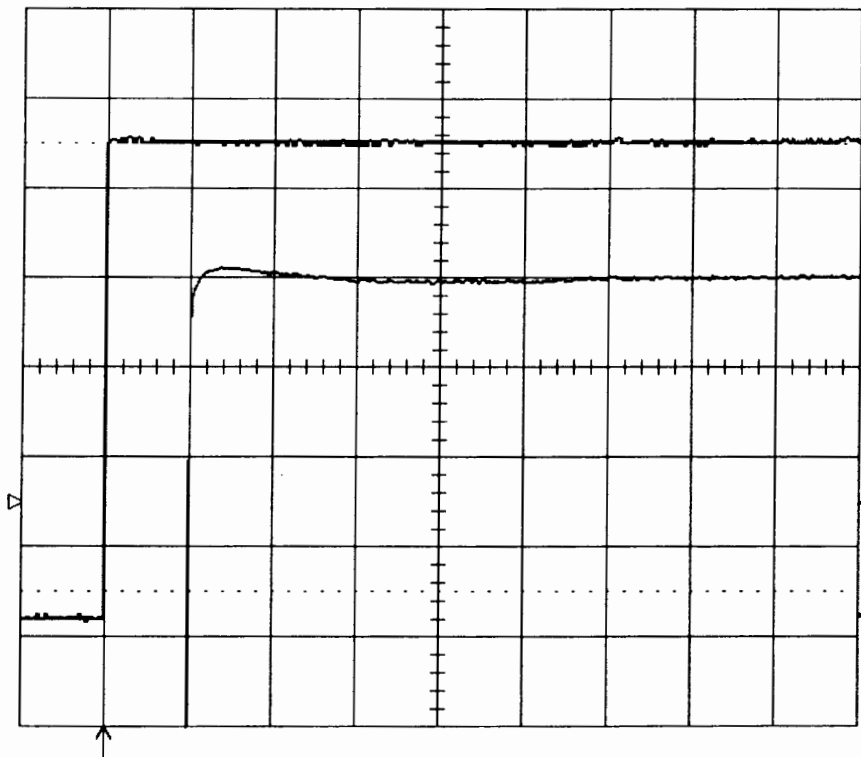

CHANNEL **3**

Coupling
DC50 Ω
Grounded
DC1M Ω
Grounded
AC1M Ω

V/div Offset
NORMAL
ECL TTL

Global BWL
OFF On
(30 MHz)

Probe Atten
x1
x2
x5
x10
x20

20 μ s

- 1** .1 V 50 Ω
- 2** .1 V 50 Ω
- 3** .2 V DC
- 4** .1 V 50 Ω

3 DC 0.248 V

NORMAL
100 Ms/s

7.6.3.6.4 Channel 4 HF Adjustment

- Apply the fast rise time pulse generator LeCroy 4969 or equivalent (< 600 psec) to Channel 4. Set pulser to 62.5 msec low frequency.

- Turn on trace : Ch4
- Display setup : Standard, Persistence off, Dot join on, Single grid
- Coupling Channel 4 : DC 50 Ω
- V/div. offset : Normal
- Global BWL : Off
- Probe atten : X1
- Input offset : - 250 mV
- Input gain : 100 mV/div

- Trigger setup : Edge
- Trigger on : 4
- Trigger level : DC 250 mV
- Coupling 4 : DC
- Slope 4 : Pos
- Mode : Normal
- Holdoff : Off

- Timebase : 20 μ sec/div
- Record up to : 50K samples
- Delay : 10 % Pre-Trigger

- Turn on trace : D
- Select Math Setup
- For Math : Use at most 1000 points
- Redefine D
- Use Math ? : Yes
- Math Type : Average
- Avg Type : Summed
- Of : Channel D

- With the vertical Zoom set D to 10 mV

- Adjust pot R4041 to get a flat square wave.

- Set Input gain : 200 mV/div
- Coupling Channel 4 : DC 1 M Ω

- Adjust cap C4009 to get a flat square wave.

11-Nov-94
9:25:57

4
20 μ s
100 mV

0: Average(**4**)
20 μ s
10.0 mV
727 swps

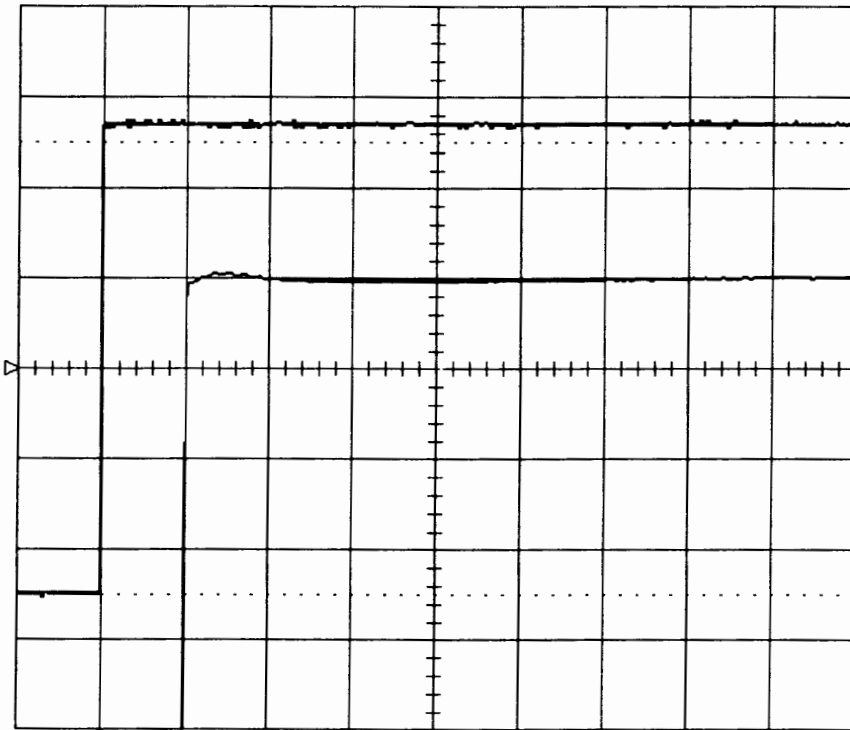

SETUP OF **0**

use Math?
No **Yes**

Math Type
Arithmetic
Average
Functions

Avg Type
Summed

for
1000
(sweeps)

of
1 2 3 4 A B C
M1 M2 M3 M4

100 MS/s

NORMAL

20 μ s

- 1** .1 V 50 Ω
- 2** .1 V 50 Ω
- 3** .1 V 50 Ω
- 4** .1 V 50 Ω

0: Average(**4**)
20000 -> 1000 pts

11-Nov-94
9:26:57

4
20 μ s
200 mV

0: Average(**4**)
20 μ s
20.0 mV
229 swps

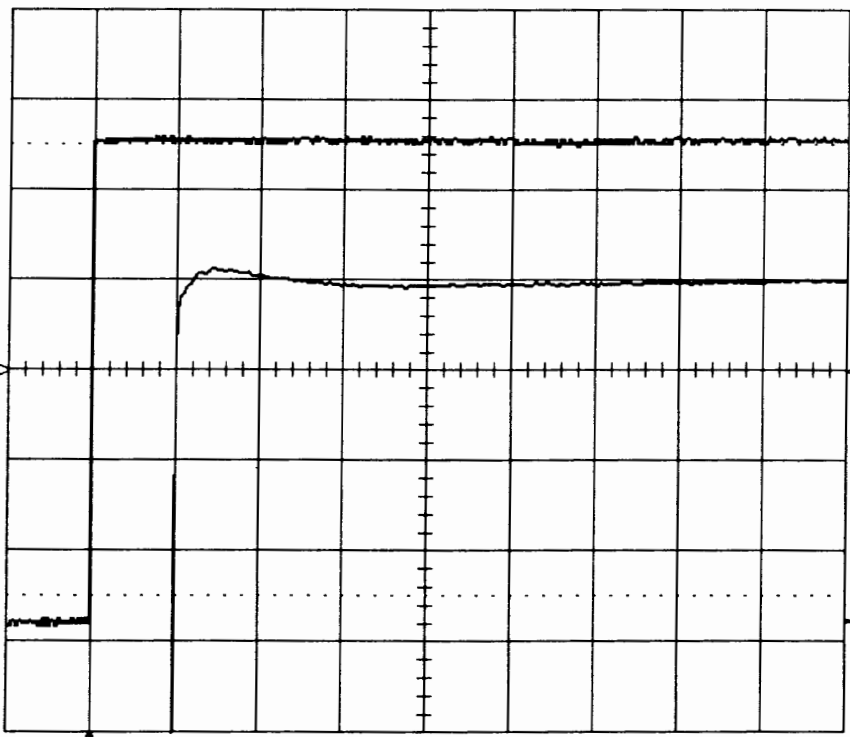

CHANNEL **4**

Coupling
DC50 Ω
Grounded
DC1M Ω
Grounded
AC1M Ω

V/div Offset
NORMAL
ECL TTL

Global BWL
OFF On
(30 MHz)

Probe Atten
x1
x2
x5
x10
x20

100 MS/s

NORMAL

20 μ s

- 1** .1 V 50 Ω
- 2** .1 V 50 Ω
- 3** .1 V 50 Ω
- 4** .2 V DC

4 DC 0.552 V

7.6.3.7 Trigger Hysteresis Control

7.6.3.7.1 Channel Trigger Hysteresis Control

- In the Calibration Diagnostics select Diagnostics Results.
- Select Results for Trigger level, and Show Result for Channel 1
- Push Recalibrate Completely

11-Nov-94
9:30:34
28°

CALIBRATION

Trigger Level Calibration Results

1 10.0 ns

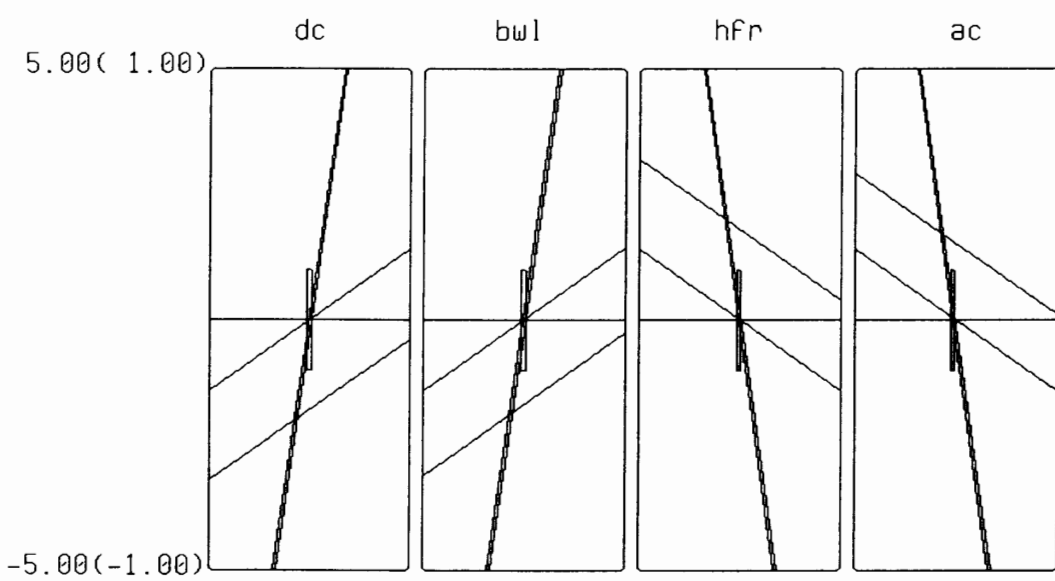

Diagnostic Summary

Results for
Gain
Offset
Trigger Level
Validate Lev

Diagnostic Measurements

Recalibrate Completely

Show Result For Channel
1 2 3 4 E

hysteresis [div]	0.357	0.335	-0.359	-0.302
offset [div]	-0.258	-0.171	0.133	-0.162

Monitor: rc 10; 1: Δg -51, Δo -6

- Adjust potentiometer R5056 to get :
 $DC \text{ Hysteresis (div)} = 0.35 \text{ div} \pm 0.05 \text{ div}$
- Select Show Result for Channel 2
- Push Recalibrate Completely
- Check Channel 2 DC Hysteresis (div) = 0.35 div ± 0.05 div
- Repeat test for Channel 3 and Channel 4

7.6.3.7.2 External Trigger Hysteresis Control

- Select Show Result for External Trigger
- Push Recalibrate Completely
- Check External DC Hysteresis (V) = 0.025 V ± 0.01

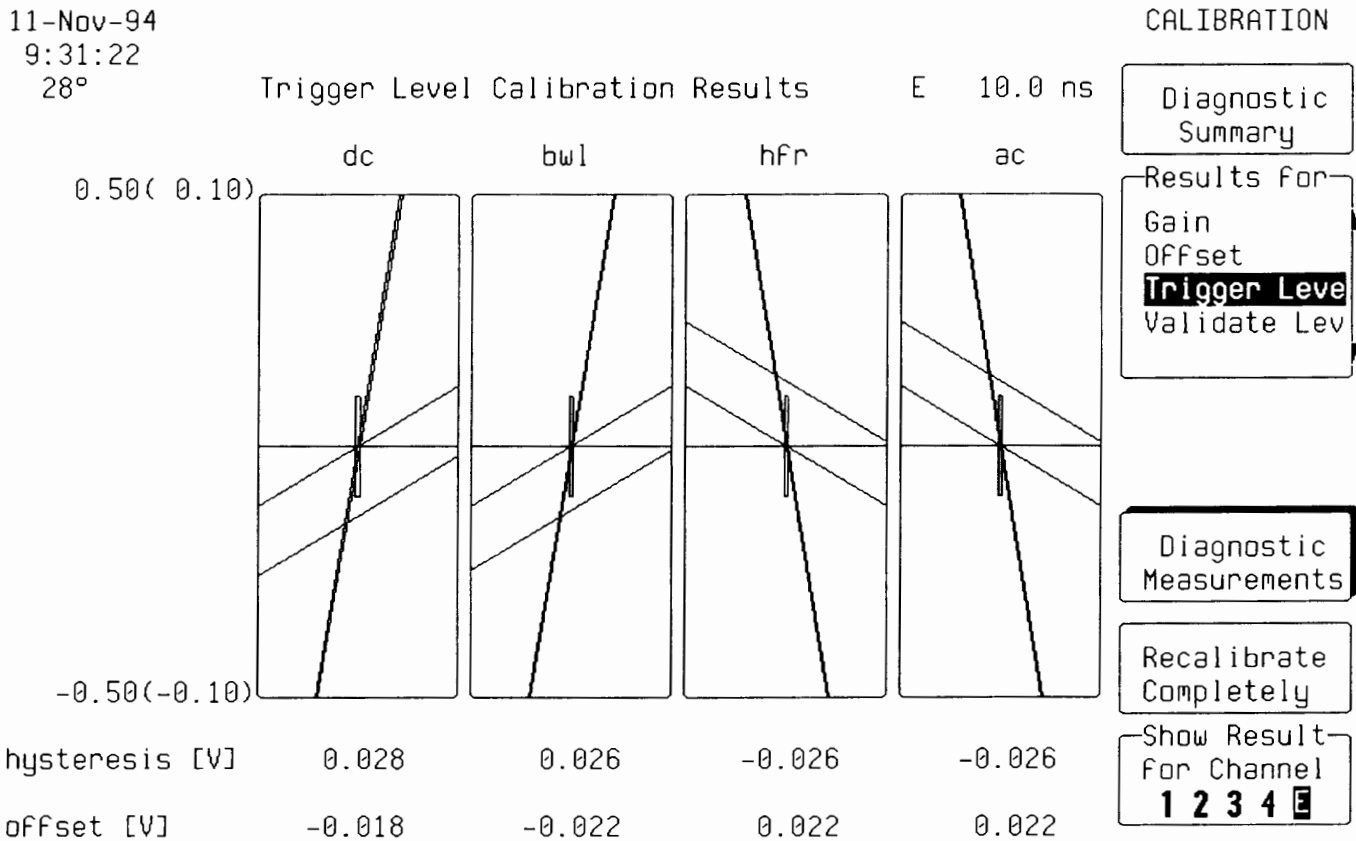

Monitor: rc 10

7.6.3.8 Validate Hysteresis Control

7.6.3.8.1 Channel Validate Hysteresis Control

- In the Calibration Diagnostics select Diagnostics Results.
- Select Results for Validate level, and Show Result for Channel 1
- Push Recalibrate Completely
- Adjust potentiometer R5054 to get :

$$\text{DC Hysteresis (div)} = 0.35 \text{ div} \pm 0.05 \text{ div}$$

- Repeat test for Channel 2, Channel 3 and Channel 4
- Check DC Hysteresis (div) = 0.35 div ± 0.05 div

Section 7 Maintenance

11-Nov-94
 9:32:32
 28°

Validate Level Calibration Results

1 10.0 ns

CALIBRATION

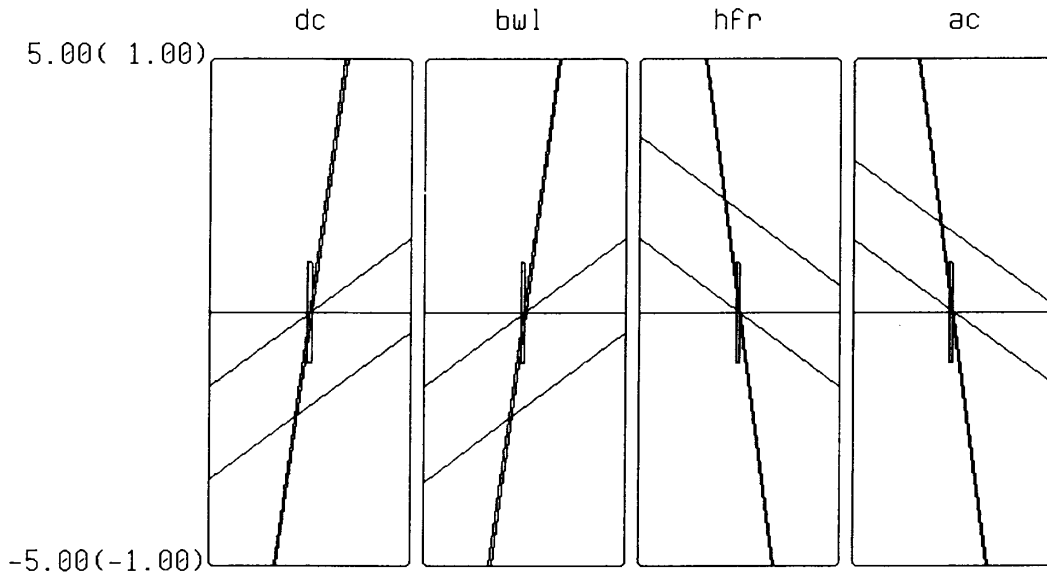

hysteresis [div]	0.371	0.376	-0.401	-0.312
offset [div]	-0.239	-0.198	0.174	-0.123

Diagnostic Summary

Results For
 Gain
 Offset
 Trigger Level
Validate Lev

Diagnostic Measurements

Recalibrate Completely

Show Result For Channel
1 2 3 4 E

7.6.3.8.2 External Validate Hysteresis Control

- Select Show Result for External Trigger
- Push Recalibrate Completely
- Check External DC Hysteresis (V) = 0.025 V ± 0.01

11-Nov-94
 9:33:09
 28°

Validate Level Calibration Results

E 10.0 ns

CALIBRATION

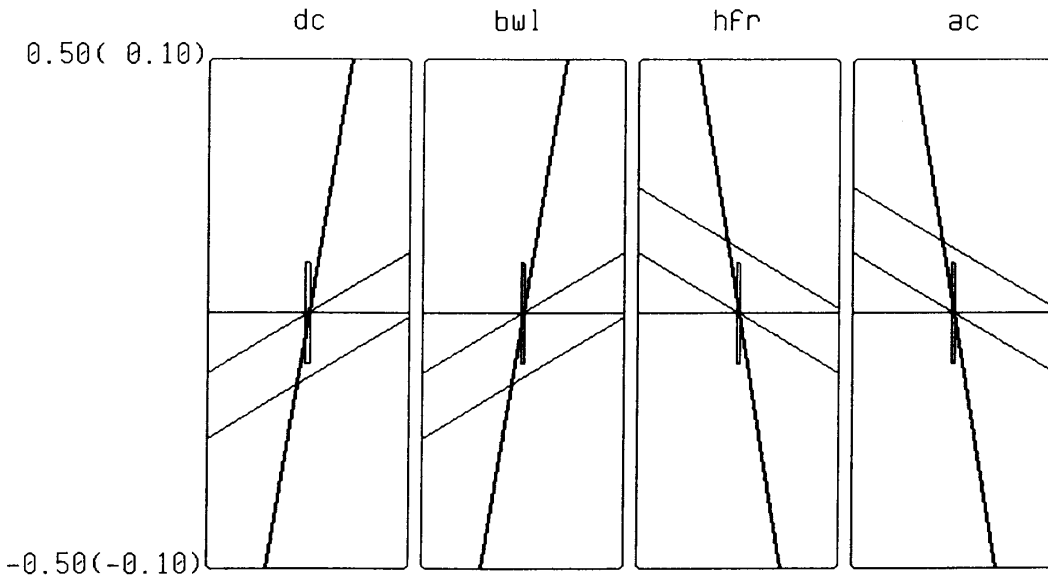

hysteresis [V]	0.026	0.026	-0.026	-0.026
offset [V]	-0.018	-0.022	0.022	0.022

Diagnostic Summary

Results For
 Gain
 Offset
 Trigger Level
Validate Lev

Diagnostic Measurements

Recalibrate Completely

Show Result For Channel
1 2 3 4 E

7.6.3.9 DC 50 Ω Overload Adjustment

7.6.3.9.1 Channel 1 DC 50 Ω Overload Adjustment

- Turn on trace : Channel 1
- Input Coupling : DC 50 Ω
- Probe atten : X1
- Input gain : 1 V/div.
- Input offset : - 3.5 V
- Trigger setup : Edge
- Trigger on : 1
- Trigger level : DC 0.1 V
- Delay : zero
- Coupling 1 : DC
- Slope 1 : Pos
- Mode : Auto
- Timebase : 2 sec/div.
- Record up to : 1000 samples

- From the power supply (Tektronix PS5004) apply DC 7.07 V (1 Watt) to Channel 1.
- Adjust the potentiometer R1011, such that the overload trips within 10 to 15 seconds.
(turn clockwise if it's too slow or counterclockwise if it's too fast)

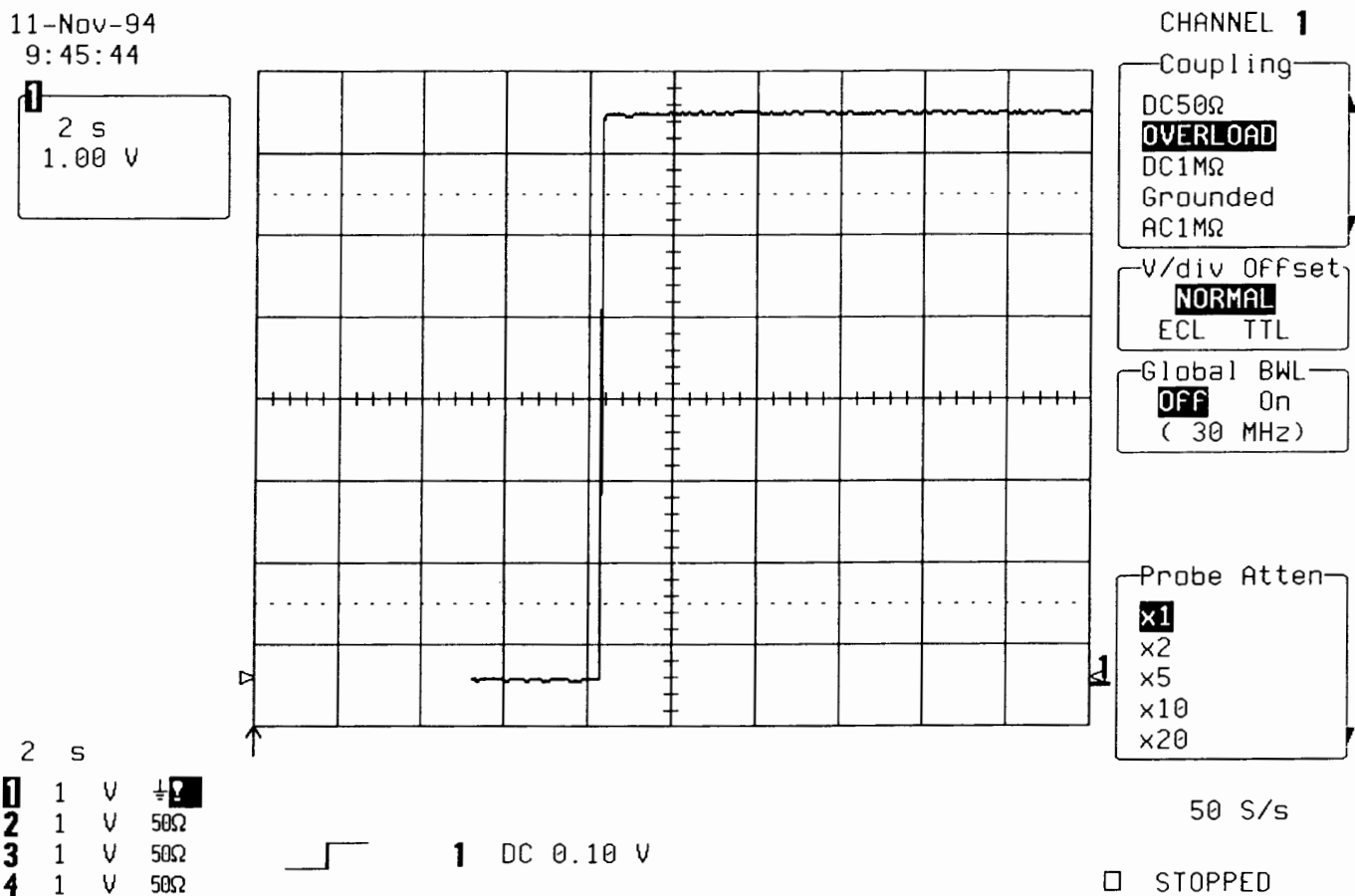

- Set Timebase : 5 sec/div.
- From the power supply (Tektronix PS5004) apply 5 V (.5 Watt) to Channel 1
- Check that the overload doesn't trip for at least 30 seconds.

7.6.3.9.2 Channel 2 DC 50 Ω Overload Adjustment

- Turn on trace : Channel 2
- Input Coupling : DC 50 Ω
- Probe atten : X1
- Input gain : 1 V/div.
- Input offset : - 3.5 V
- Trigger setup : Edge
- Trigger on : 2
- Trigger level : DC 0.1 V
- Delay : zero
- Coupling 2 : DC
- Slope 2 : Pos
- Mode : Auto
- Timebase : 2 sec/div.
- Record up to : 1000 samples

- From the power supply (Tektronix PS5004) apply DC 7.07 V (1 Watt) to Channel 2.
- Adjust the potentiometer R2011, such that the overload trips within 10 to 15 seconds.
(turn clockwise if it's too slow or counterclockwise if it's too fast)

11-Nov-94
9:48:30

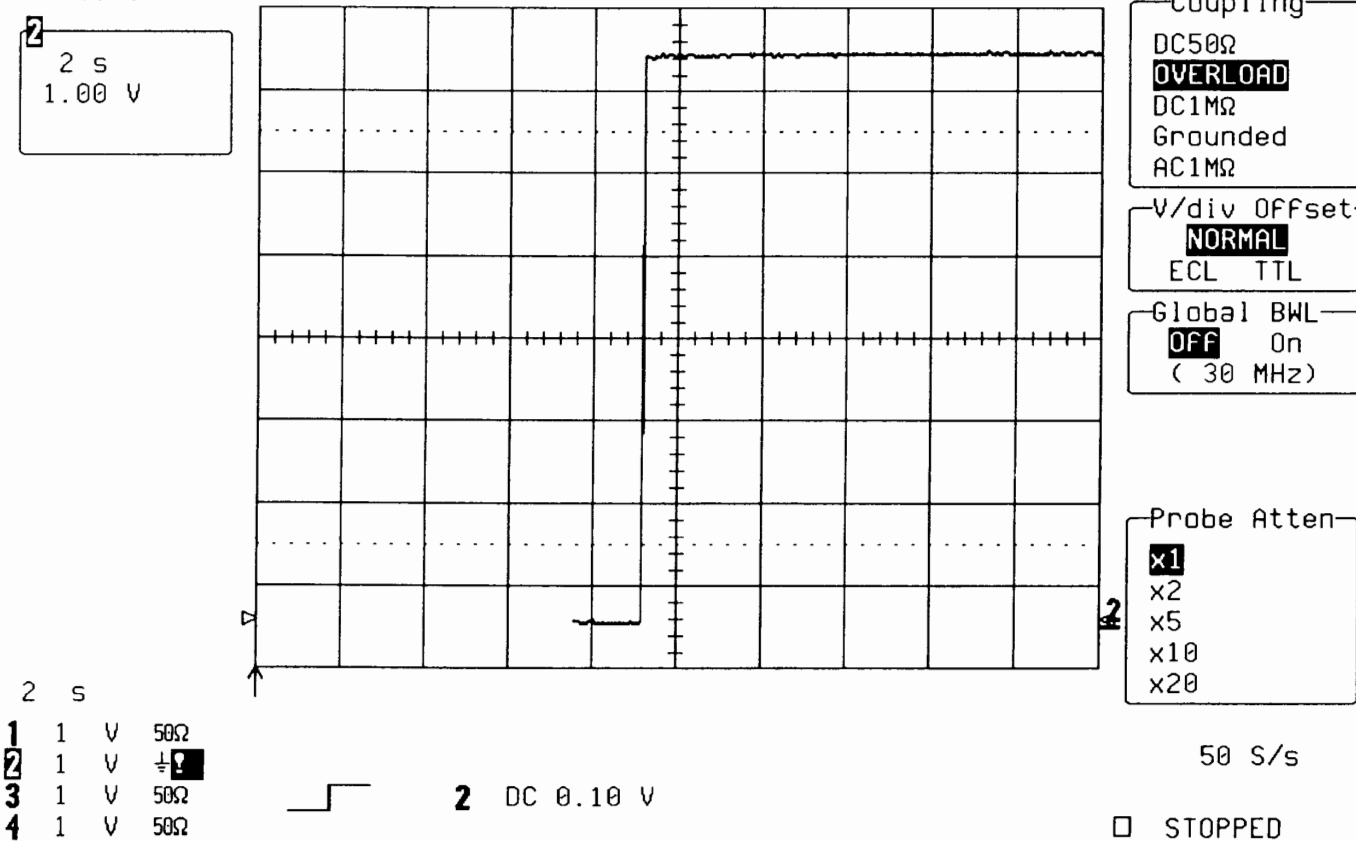

- Set Timebase : **5 sec/div.**
- From the power supply (Tektronix PS5004) apply **5 V** (.5 Watt) to Channel 2
- Check that the overload doesn't trip for at least **30** seconds.

7.6.3.9.3 Channel 3 DC 50 Ω Overload Adjustment

- Turn on trace : Channel 3
- Input Coupling : DC 50 Ω
- Probe atten : X1
- Input gain : 1 V/div.
- Input offset : - 3.5 V
- Trigger setup : Edge
- Trigger on : 3
- Trigger level : DC 0.1 V
- Delay : zero
- Coupling 3 : DC
- Slope 3 : Pos
- Mode : Auto
- Timebase : 2 sec/div.
- Record up to : 1000 samples

- From the power supply (Tektronix PS5004) apply DC 7.07 V (1 Watt) to Channel 3.
- Adjust the potentiometer R3011, such that the overload trips within 10 to 15 seconds.
(turn clockwise if it's too slow or counterclockwise if it's too fast)

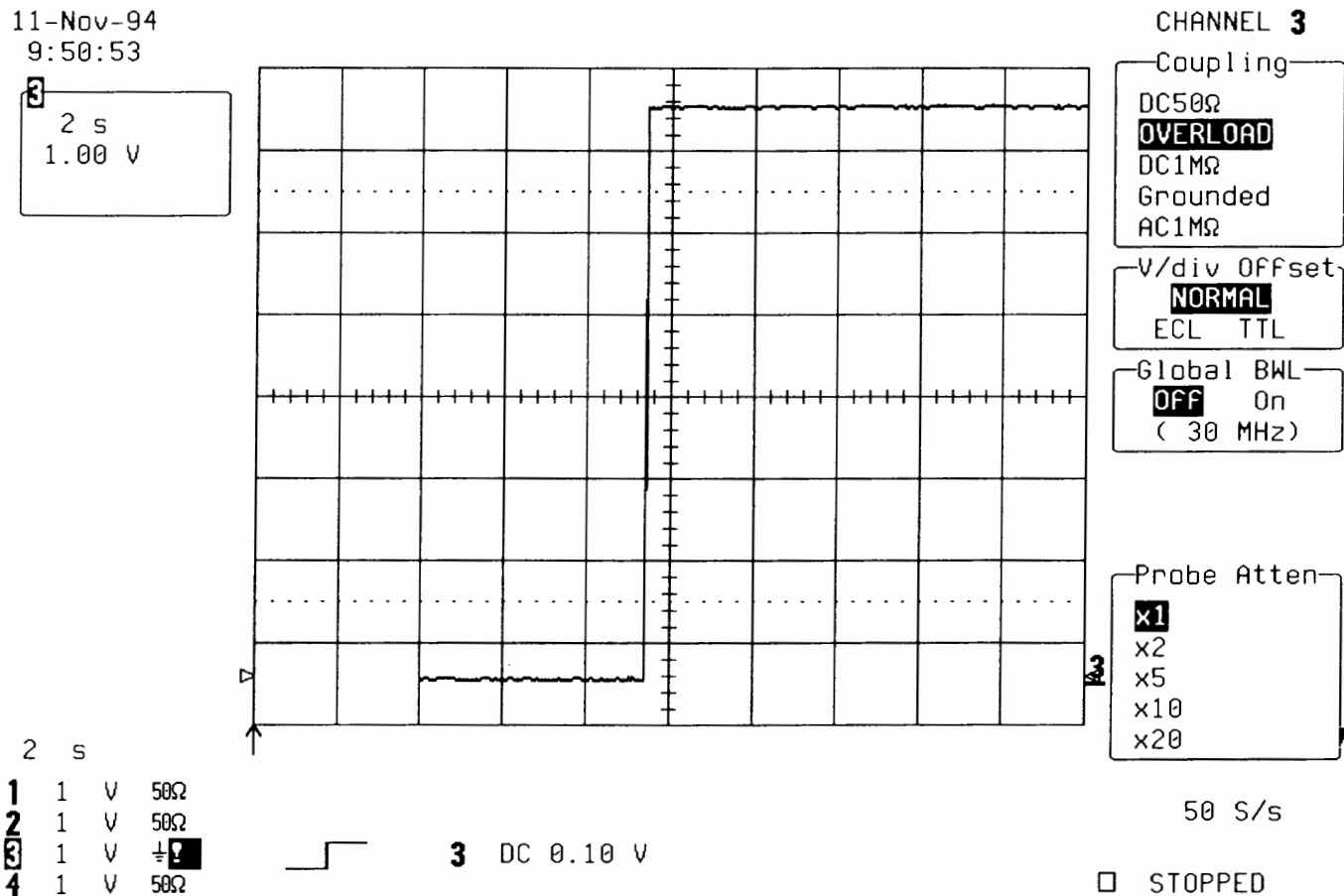

- Set Timebase : **5 sec/div.**
- From the power supply (Tektronix PS5004) apply **5 V** (.5 Watt) to Channel 3
- Check that the overload doesn't trip for at least **30** seconds.

7.6.3.9.4 Channel 4 DC 50 Ω Overload Adjustment

- Turn on trace : Channel 4
 - Input Coupling : DC 50 Ω
 - Probe atten : X1
 - Input gain : 1 V/div.
 - Input offset : - 3.5 V
 - Trigger setup : Edge
 - Trigger on : 4
 - Trigger level : DC 0.1 V
 - Delay : zero
 - Coupling 4 : DC
 - Slope 4 : Pos
 - Mode : Auto
 - Timebase : 2 sec/div.
 - Record up to : 1000 samples
- From the power supply (Tektronix PS5004) apply DC 7.07 V (1 Watt) to Channel 4.
 - Adjust the potentiometer R4011, such that the overload trips within 10 to 15 seconds.
(turn clockwise if it's too slow or counterclockwise if it's too fast)

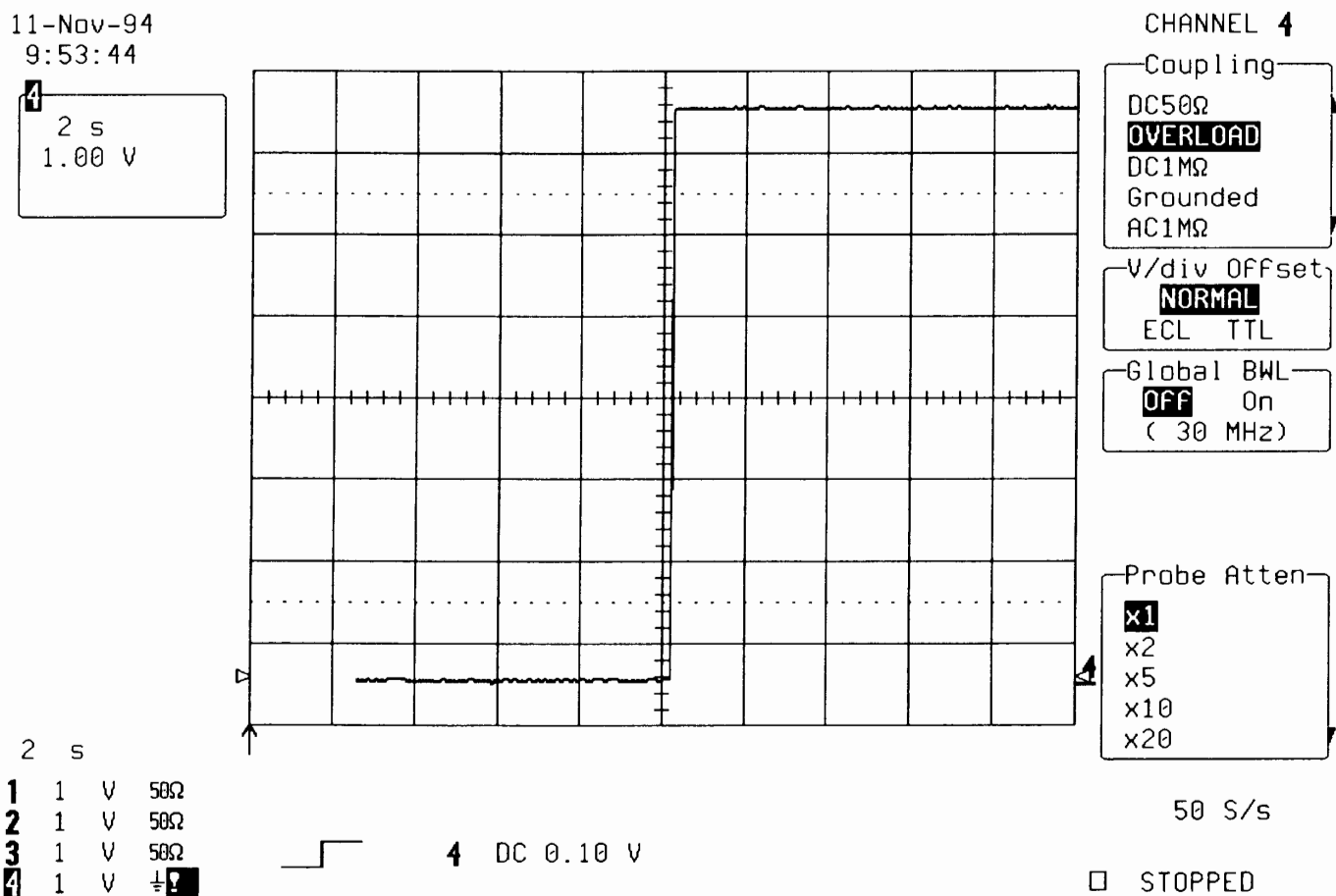

- Set Timebase : 5 sec/div.
- From the power supply (Tektronix PS5004) apply 5 V (.5 Watt) to Channel 4
- Check that the overload doesn't trip for at least 30 seconds.

SECTION 8 SCHEMATICS, LAYOUTS, PARTS LIST

9314A, 9314AM & 9314AL Digital Oscilloscope

PART : 9314A, DESC : 400 MHz, QUAD CHANNEL 100 MS/s DSO, 50 KB

COMPONENT	PART DESCRIPTION	QTY PER ASSEMBLY
205750000	IC AND-OR GATE ARRAY 16V8	1
554500001	TAPPING SCREW W/U-THREAD	2
709314A26	FRONT LABEL 9314A	1
709314913	SERIAL NUMBER PLATE 9314A	1
F9314M-1 or F9300-1-2	PROCESSOR CARD WITH 2Mb DRAM	1
F9314A-3	MAIN CARD (FRONT END, ADC, TDC)	1
F9300-4	GPIB + RS232 INTERFACE CARD	1
F9354-5	QUAD CHANNEL FRONT PANEL	1
M93XXA	MECHANICAL FOR 93XXA-SERIES	1
ACCESSORIES-9314A	ACCESSORIES FOR 9314A	1

PART : 9314AM, DESC : 400 MHz, QUAD CHANNEL 100 MS/s DSO, 200 KB

COMPONENT	PART DESCRIPTION	QTY PER ASSEMBLY
205750000	IC AND-OR GATE ARRAY 16V8	1
554500001	TAPPING SCREW W/U-THREAD	2
709314AM26	FRONT LABEL 9314AM	1
709314913	SERIAL NUMBER PLATE 9314AM	1
F9314M-1 or F9300-1-2	PROCESSOR CARD WITH 2Mb DRAM	1
F9314AM-3	MAIN CARD (FRONT END, ADC, TDC)	1
F9300-4	GPIB + RS232 INTERFACE CARD	1
F9354-5	QUAD CHANNEL FRONT PANEL	1
M93XXA	MECHANICAL FOR 93XXA-SERIES	1
ACCESSORIES-9314A	ACCESSORIES FOR 9314AM	1

PART : 9314AL, DESC : 400 MHz, QUAD CHANNEL 100 MS/s DSO, 1 MB

COMPONENT	PART DESCRIPTION	QTY PER ASSEMBLY
205750000	IC AND-OR GATE ARRAY 16V8	1
554500001	TAPPING SCREW W/U-THREAD	2
709314AL26	FRONT LABEL 9314AL	1
709314913	SERIAL NUMBER PLATE 9314AL	1
F9314M-1 or F9300-1-2	PROCESSOR CARD WITH 2Mb DRAM	1
F9314AL-3	MAIN CARD (FRONT END, ADC, TDC)	1
F9300-4	GPIB + RS232 INTERFACE CARD	1
F9354-5	QUAD CHANNEL FRONT PANEL	1
M93XXA	MECHANICAL FOR 93XXA-SERIES	1
ACCESSORIES-9314A	ACCESSORIES FOR 9314AL	1

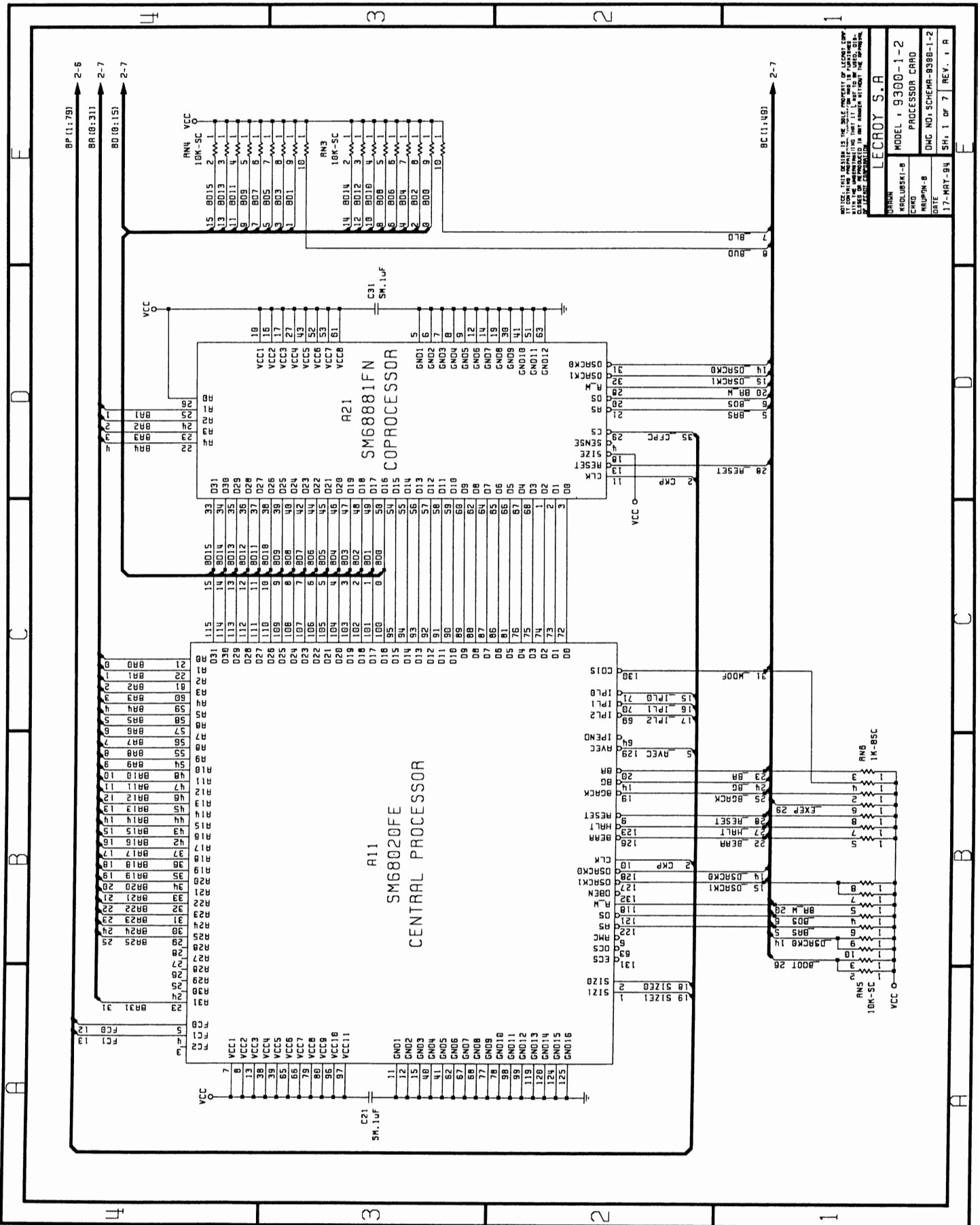

NOTICE: THIS DESIGN IS THE SOLE PROPERTY OF LECROY CORP. ALL RIGHTS ARE RESERVED. NO PART OF THIS DESIGN IS TO BE REPRODUCED OR TRANSMITTED IN ANY FORM OR BY ANY MEANS, ELECTRONIC OR MECHANICAL, INCLUDING PHOTOCOPYING, RECORDING, OR BY ANY INFORMATION STORAGE AND RETRIEVAL SYSTEM, WITHOUT THE WRITTEN PERMISSION OF LECROY CORP.

DATE: 17-MAY-94

REV: 1 A

SPR: 1 OF 7

DMC NO: SCHEM-8588-1-2

PROCESSOR CARD

MODEL: 9300-1-2

LECROY S.A.

WOLUASKI-B

ADAM

Section 8 Schematics, Layouts, Parts list

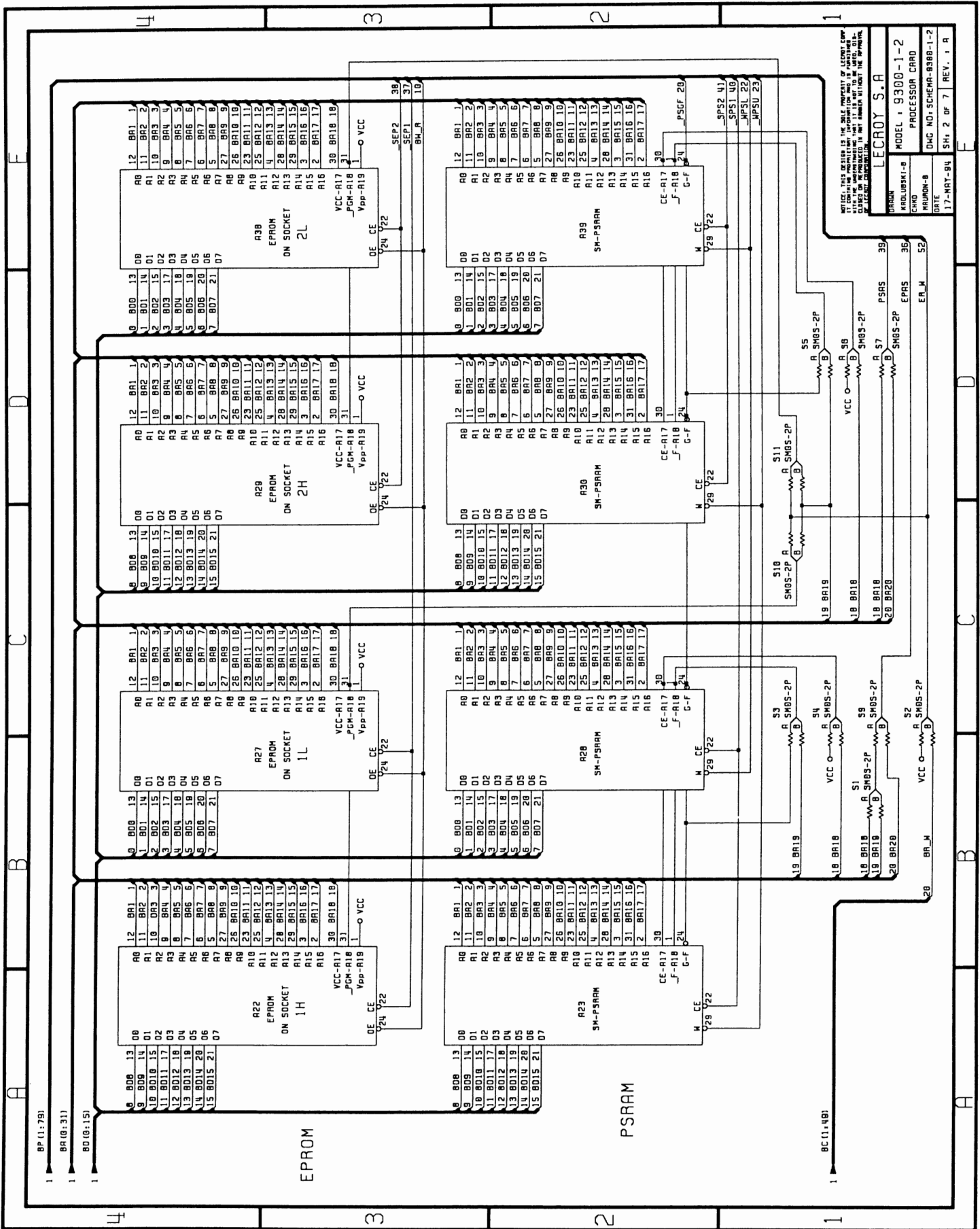

NOTICE: THIS DESIGN IS THE SOLE PROPERTY OF LECROY LOW
 FREQUENCY SYSTEMS CORPORATION. ANY REPRODUCTION,
 IN WHOLE OR IN PART, WITHOUT THE WRITTEN
 CONSENT OF LECROY LOW FREQUENCY SYSTEMS CORPORATION
 IS PROHIBITED.

LECRAY S.A

MODEL : 9300-1-2
 PROCESSOR CARD
 DRAM
 KARLUSKI-B
 CKMD
 PRIMO-B
 DATE
 17-MAY-84

SH, 2 of 7 REV. 1 A

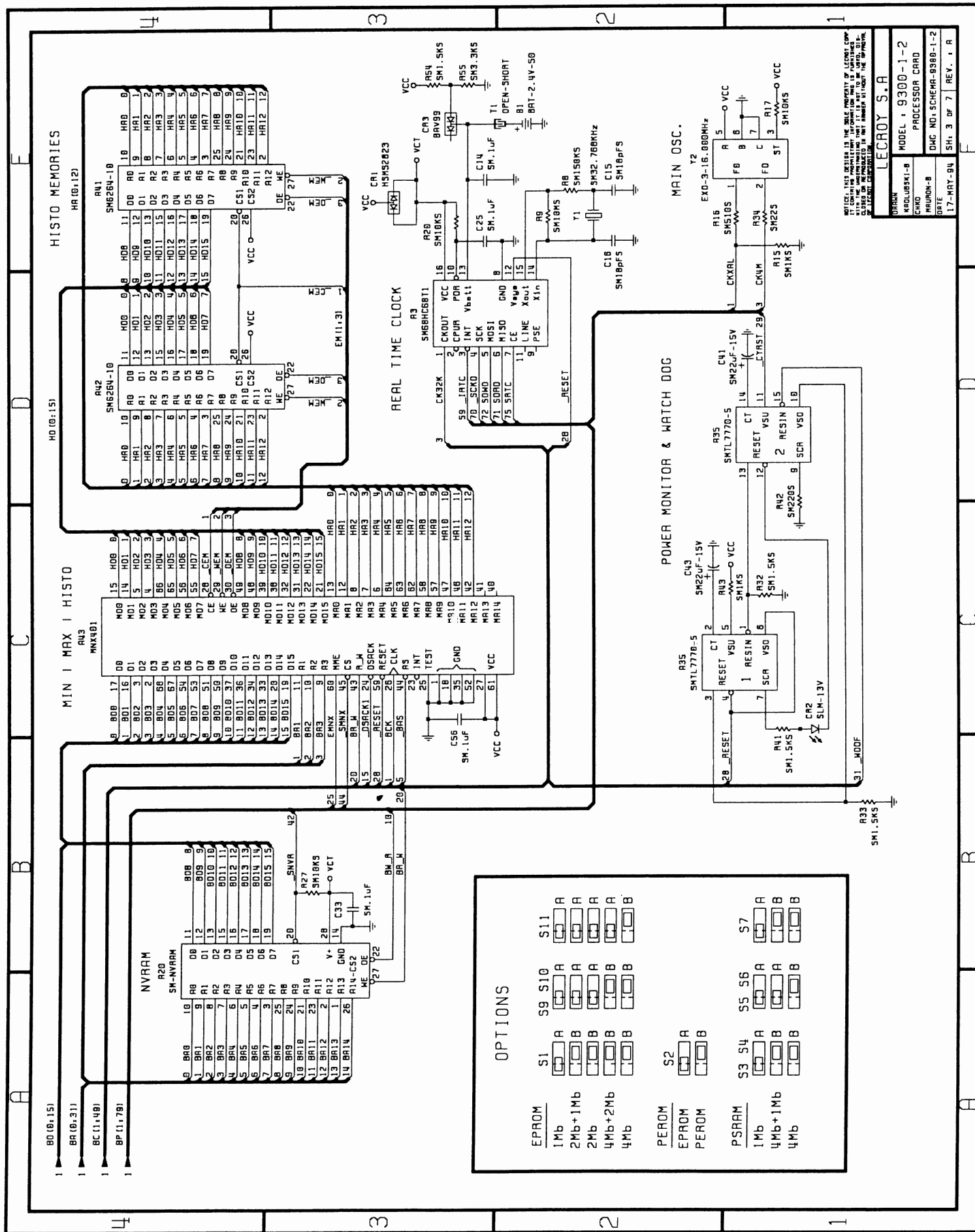

NOTICE: THIS DEVICE IS THE SOLE PROPERTY OF LECROY CORP. IT IS TO BE USED ONLY FOR THE PURPOSES INTENDED BY LECROY CORP. IT IS NOT TO BE REPRODUCED, COPIED, OR TRANSMITTED IN ANY FORM OR BY ANY MEANS, ELECTRONIC OR MECHANICAL, INCLUDING PHOTOCOPYING, RECORDING, OR BY ANY INFORMATION STORAGE AND RETRIEVAL SYSTEM.

LECROY S.A.
 MODEL: 9300-1-2
 PROCESSOR CARD
 DHC NO. SCHEM-9300-1-2
 DATE: 17-MAY-94
 SH: 3 DP: 7 REV: 1 A

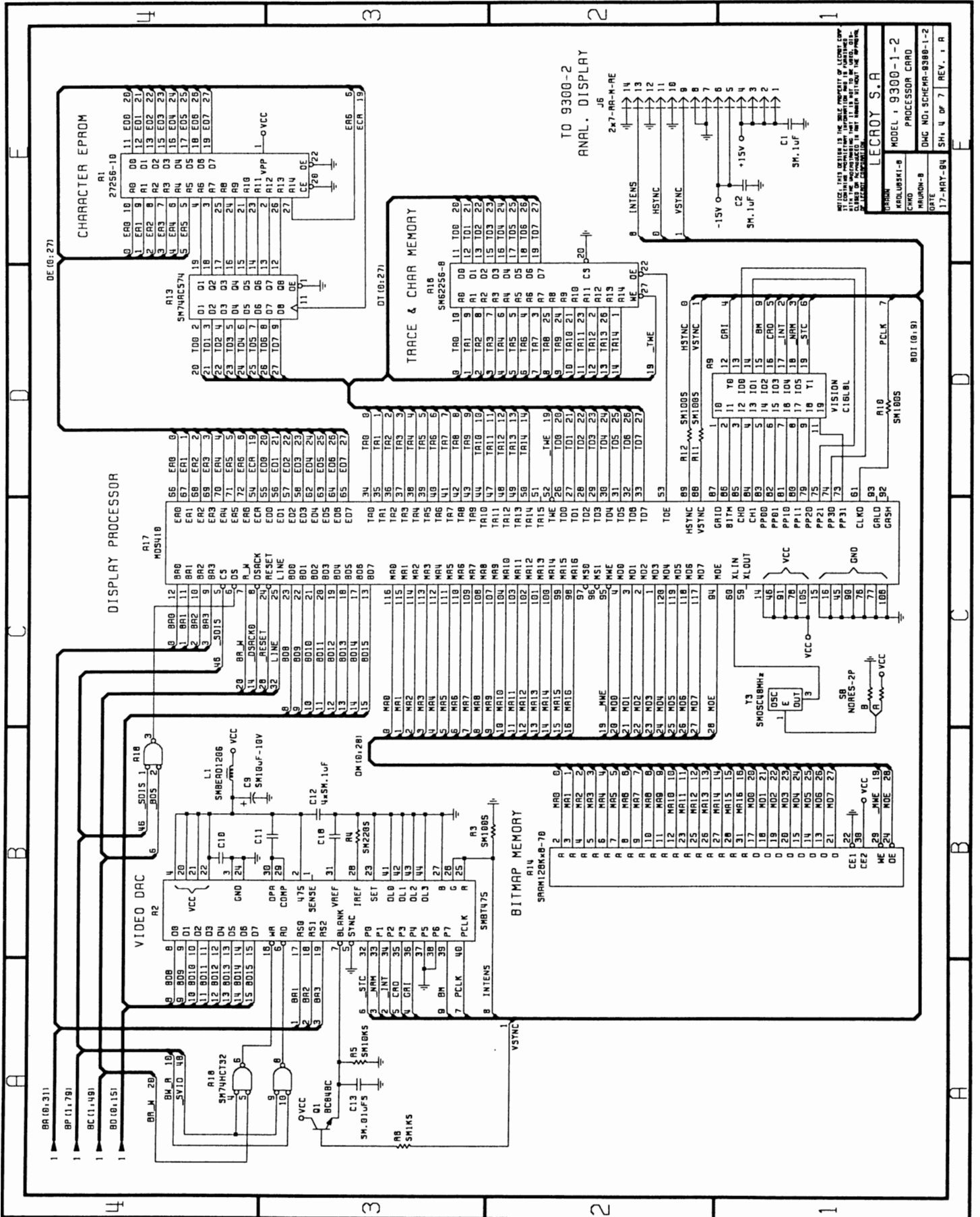

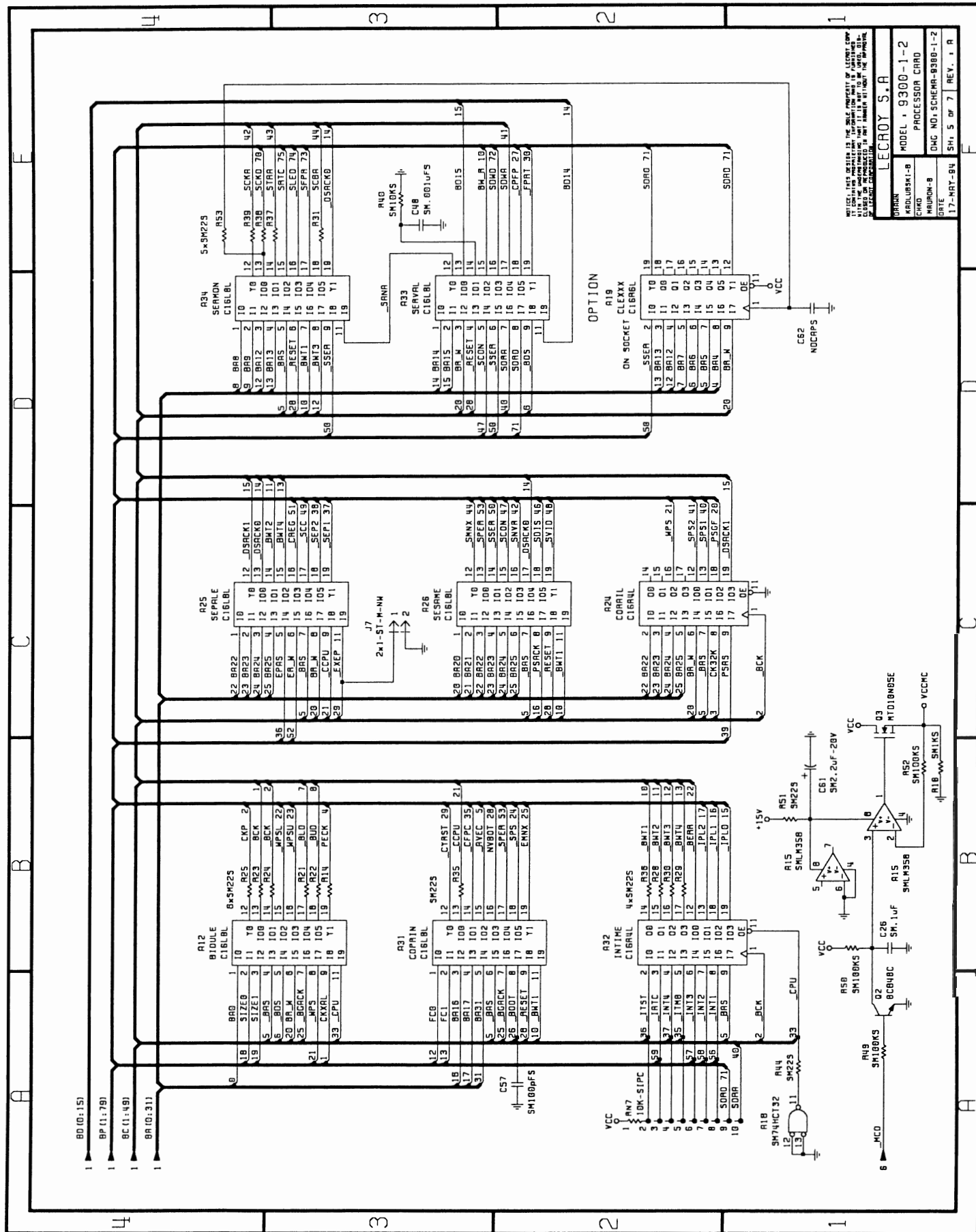

Section 8 Schematics, Layouts, Parts list

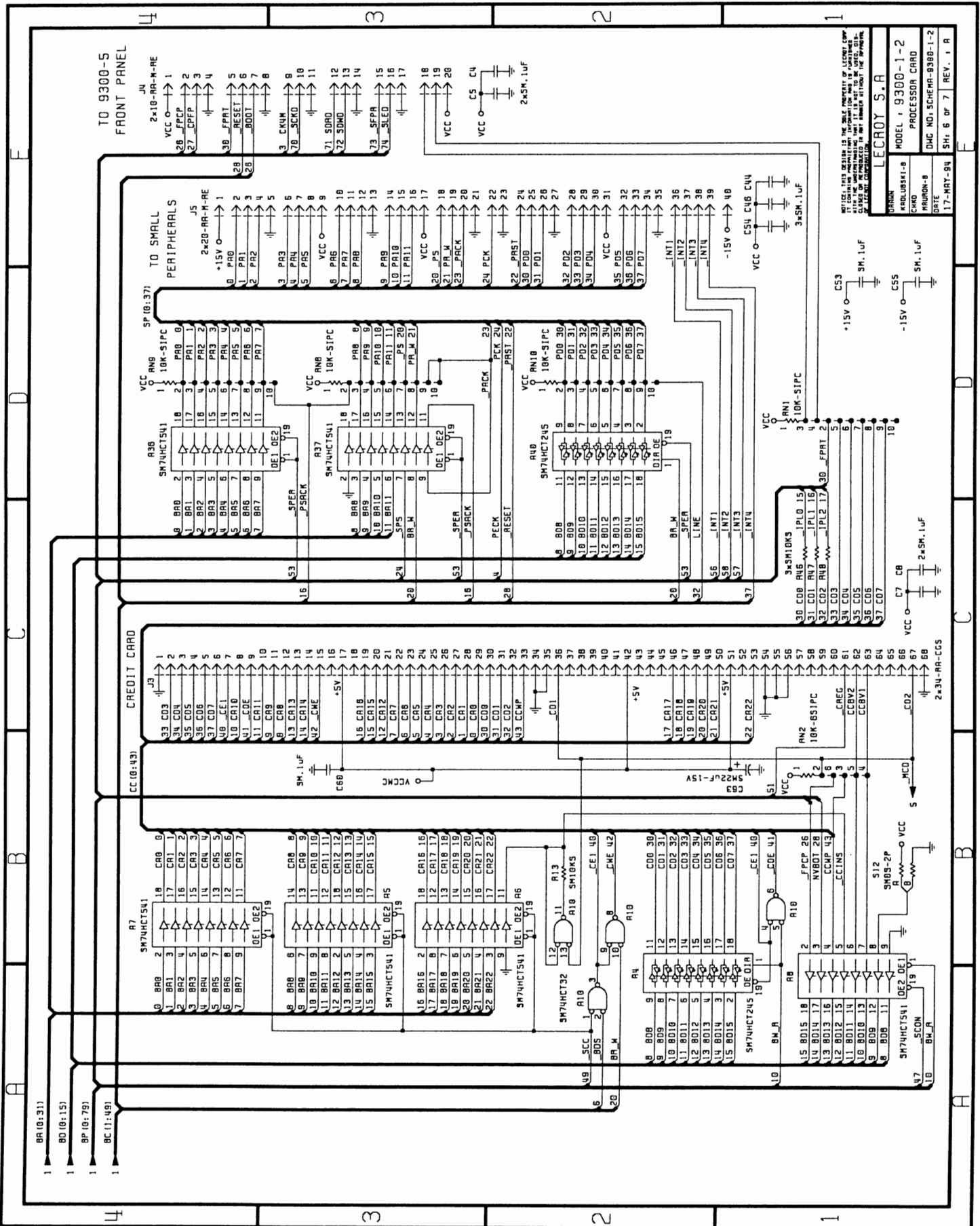

TO 9300-5 FRONT PANEL

JN
2x10-AR-M-RE
VCC O → 1
26_FFCP → 2
27_CFP → 3
4 → 4
30_FFR1 → 5
28 → 6
28 → 7
3 CKUM → 9
78_SCKD → 10
11 → 11
71_SDRD → 12
72_SDMO → 13
14 → 14
73_SFPA → 15
16 → 16
17 → 17
18 → 18
19 → 19
VCC O → 20
20 → 20
VCC O → C5 C4
2x5M.1uF

TO SMALL PERIPHERALS

JS
2x20-AR-M-RE
+15V O → 1
9_PAB → 2
10_PAB → 3
11_PAB → 4
12_PAB → 5
13_PAB → 6
14_PAB → 7
15_PAB → 8
16_PAB → 9
17_PAB → 10
18_PAB → 11
19_PAB → 12
20_PAB → 13
21_PAB → 14
22_PAB → 15
23_PAB → 16
24_PAB → 17
25_PAB → 18
26_PAB → 19
27_PAB → 20
28_PAB → 21
29_PAB → 22
30_PAB → 23
31_PAB → 24
32_PAB → 25
33_PAB → 26
34_PAB → 27
35_PAB → 28
36_PAB → 29
37_PAB → 30
38_PAB → 31
39_PAB → 32
40_PAB → 33
41_PAB → 34
42_PAB → 35
43_PAB → 36
44_PAB → 37
45_PAB → 38
46_PAB → 39
47_PAB → 40
48_PAB → 41
49_PAB → 42
50_PAB → 43
51_PAB → 44
52_PAB → 45
53_PAB → 46
54_PAB → 47
55_PAB → 48
56_PAB → 49
57_PAB → 50
58_PAB → 51
59_PAB → 52
60_PAB → 53
61_PAB → 54
62_PAB → 55
63_PAB → 56
64_PAB → 57
65_PAB → 58
66_PAB → 59
67_PAB → 60
68_PAB → 61
69_PAB → 62
70_PAB → 63
71_PAB → 64
72_PAB → 65
73_PAB → 66
74_PAB → 67
75_PAB → 68
76_PAB → 69
77_PAB → 70
78_PAB → 71
79_PAB → 72
80_PAB → 73
81_PAB → 74
82_PAB → 75
83_PAB → 76
84_PAB → 77
85_PAB → 78
86_PAB → 79
87_PAB → 80
88_PAB → 81
89_PAB → 82
90_PAB → 83
91_PAB → 84
92_PAB → 85
93_PAB → 86
94_PAB → 87
95_PAB → 88
96_PAB → 89
97_PAB → 90
98_PAB → 91
99_PAB → 92
100_PAB → 93

TO SMALL PERIPHERALS

SP (0:37)

18K-S1PC
1 18K-S1PC
2 18K-S1PC
3 18K-S1PC
4 18K-S1PC
5 18K-S1PC
6 18K-S1PC
7 18K-S1PC
8 18K-S1PC
9 18K-S1PC
10 18K-S1PC
11 18K-S1PC
12 18K-S1PC
13 18K-S1PC
14 18K-S1PC
15 18K-S1PC
16 18K-S1PC
17 18K-S1PC
18 18K-S1PC
19 18K-S1PC
20 18K-S1PC
21 18K-S1PC
22 18K-S1PC
23 18K-S1PC
24 18K-S1PC
25 18K-S1PC
26 18K-S1PC
27 18K-S1PC
28 18K-S1PC
29 18K-S1PC
30 18K-S1PC
31 18K-S1PC
32 18K-S1PC
33 18K-S1PC
34 18K-S1PC
35 18K-S1PC
36 18K-S1PC
37 18K-S1PC
38 18K-S1PC
39 18K-S1PC
40 18K-S1PC
41 18K-S1PC
42 18K-S1PC
43 18K-S1PC
44 18K-S1PC
45 18K-S1PC
46 18K-S1PC
47 18K-S1PC
48 18K-S1PC
49 18K-S1PC
50 18K-S1PC
51 18K-S1PC
52 18K-S1PC
53 18K-S1PC
54 18K-S1PC
55 18K-S1PC
56 18K-S1PC
57 18K-S1PC
58 18K-S1PC
59 18K-S1PC
60 18K-S1PC
61 18K-S1PC
62 18K-S1PC
63 18K-S1PC
64 18K-S1PC
65 18K-S1PC
66 18K-S1PC
67 18K-S1PC
68 18K-S1PC
69 18K-S1PC
70 18K-S1PC
71 18K-S1PC
72 18K-S1PC
73 18K-S1PC
74 18K-S1PC
75 18K-S1PC
76 18K-S1PC
77 18K-S1PC
78 18K-S1PC
79 18K-S1PC
80 18K-S1PC
81 18K-S1PC
82 18K-S1PC
83 18K-S1PC
84 18K-S1PC
85 18K-S1PC
86 18K-S1PC
87 18K-S1PC
88 18K-S1PC
89 18K-S1PC
90 18K-S1PC
91 18K-S1PC
92 18K-S1PC
93 18K-S1PC
94 18K-S1PC
95 18K-S1PC
96 18K-S1PC
97 18K-S1PC
98 18K-S1PC
99 18K-S1PC
100 18K-S1PC

LECROY S.A.
MODEL : 9300-1-2
PROCESSOR CARD
DHC NO. SCHEMA-9300-1-2
SH: 6 OF 7 REV. 1 A

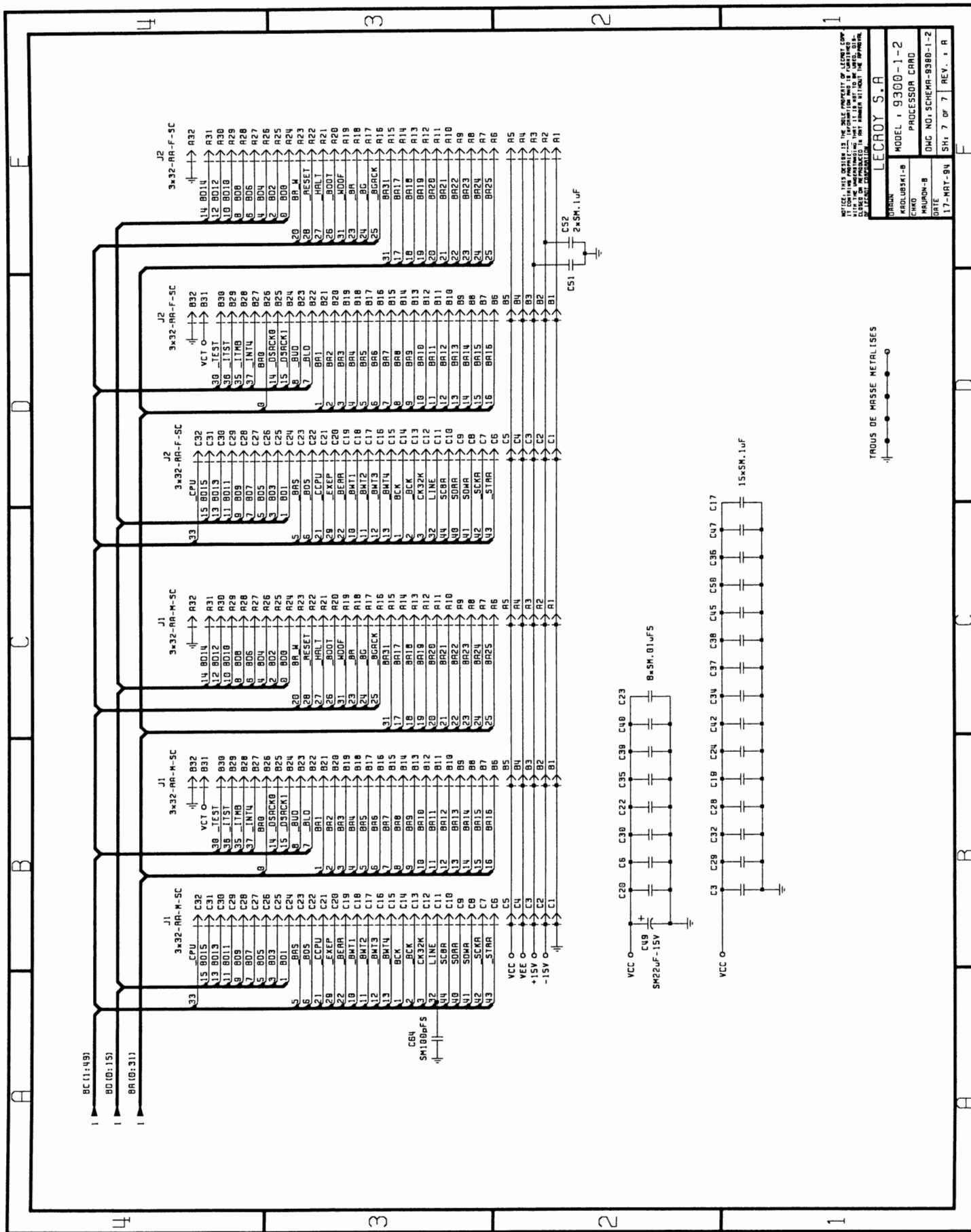

NOTICE: THIS DESIGN IS THE SOLE PROPERTY OF LECROY CORP. ALL RIGHTS RESERVED. THIS DESIGN IS THE PROPERTY OF LECROY CORP. AND IS NOT TO BE REPRODUCED OR TRANSMITTED IN ANY FORM OR BY ANY MEANS WITHOUT THE EXPRESS WRITTEN PERMISSION OF LECROY CORP.

LECROY S.A.

MODEL : 9300-1-2
PROCESSOR CARD

DWG NO: SCHEMA-9380-1-2
REV. : A

DATE : 17-MAR-94
REV. : A

9300-1 Rev:F

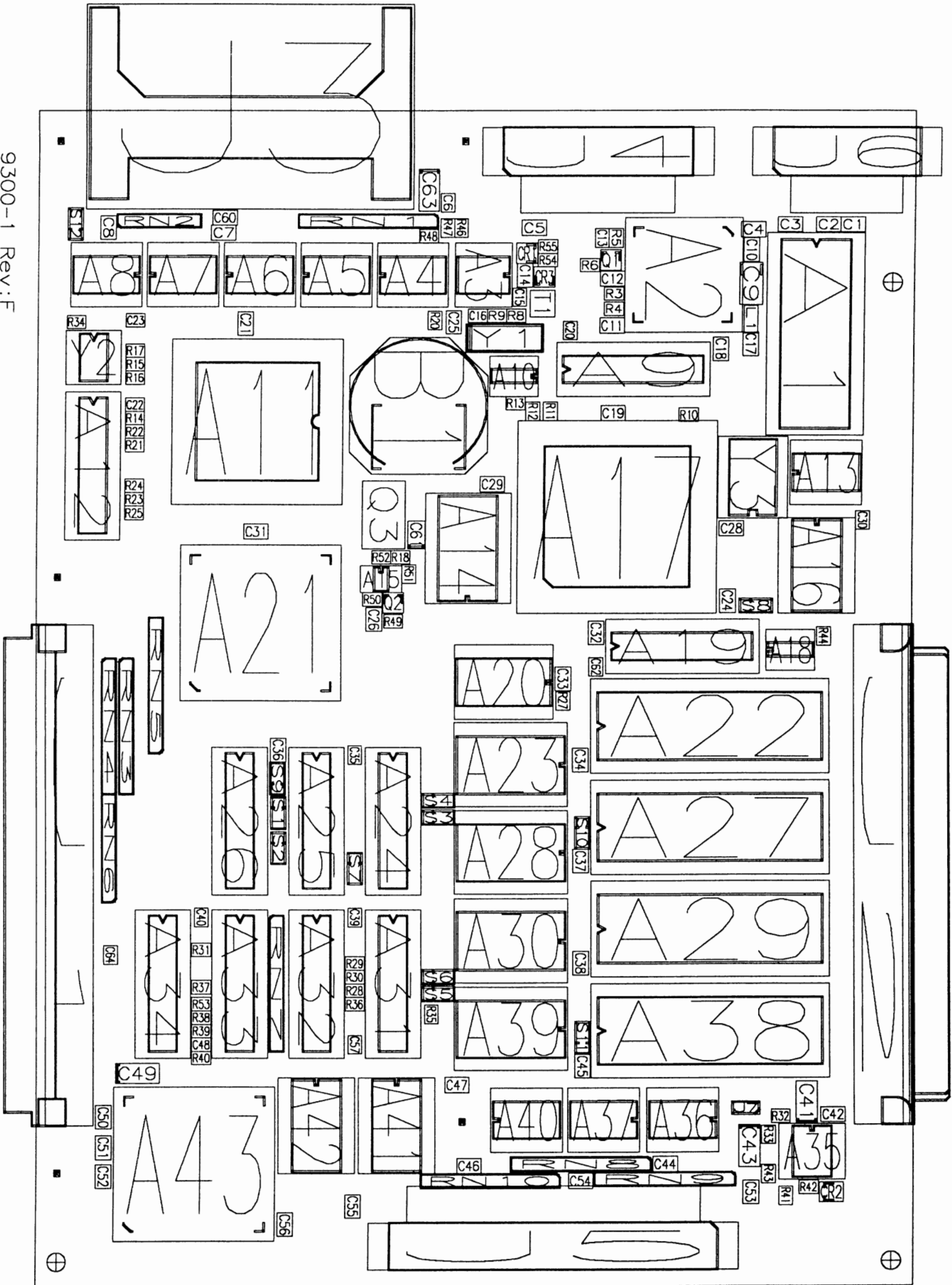

9300-1 Rev:F

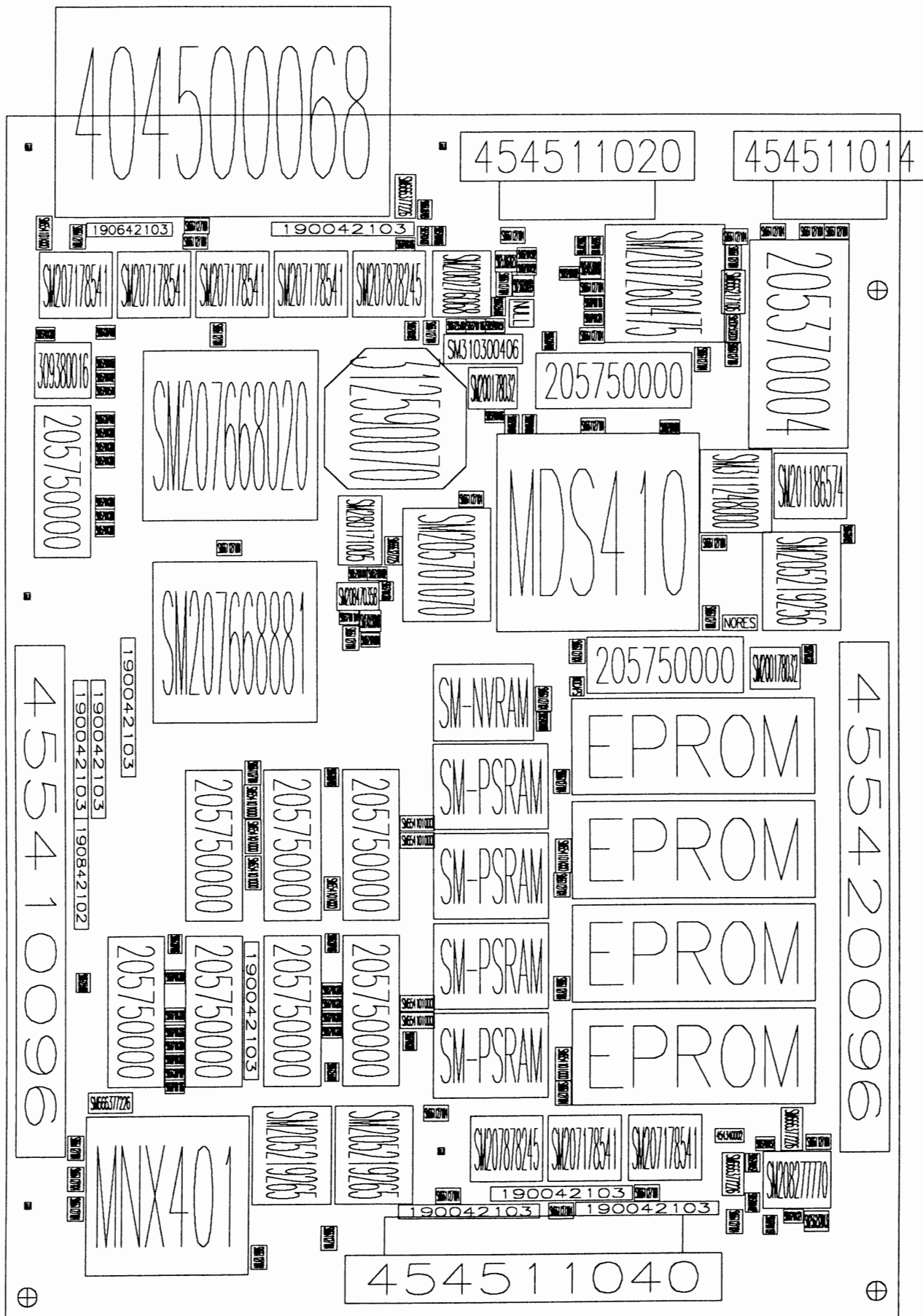

9300-1 Rev:F

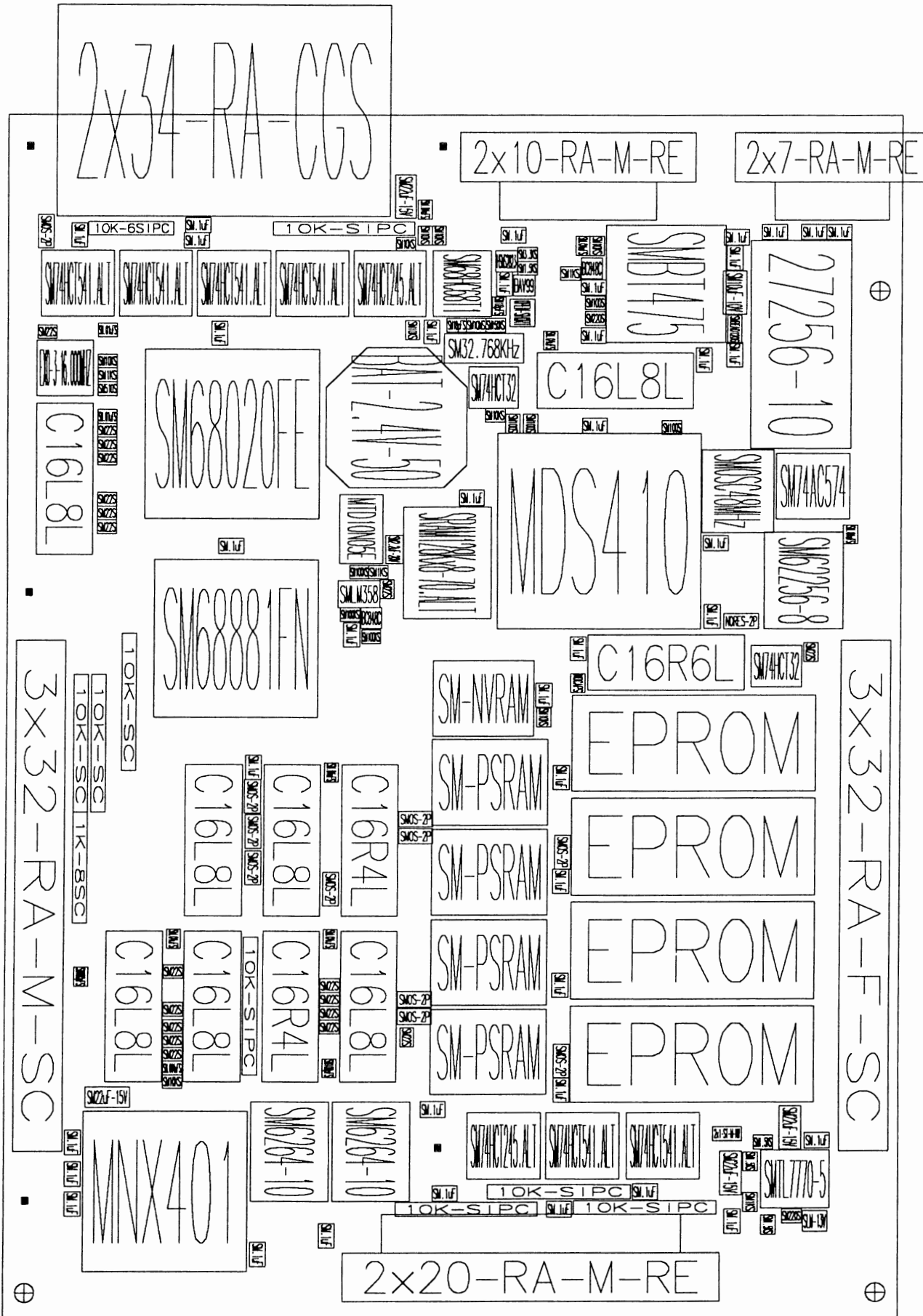

PART: F9314M-1 or F9300-1-2 DESC: PROCESSOR CARD with 2Mb RAM

Location	Part Number	Description	Location	Part Number	Description
A1	205370004	27256-10	C2	SM661127104	SM.1uF
A2	SM207260475	SMBT475	C3	SM661127104	SM.1uF
A3	SM200276068	SM68HC68T1	C4	SM661127104	SM.1uF
A4	SM207878245	SM74HCT245	C5	SM661127104	SM.1uF
A5	SM207178541	SM74HCT541	C6	SM661207103	SM.01uF
A6	SM207178541	SM74HCT541	C7	SM661127104	SM.1uF
A7	SM207178541	SM74HCT541	C8	SM661127104	SM.1uF
A8	SM207178541	SM74HCT541	C9	SM666217106	SM10uF-10V
A9	205750000	C16L8L	C10	SM661127104	SM.1uF
A10	SM200178032	SM74HCT32	C11	SM661127104	SM.1uF
A11	SM207668020	SM68020FE	C12	SM661127104	SM.1uF
A12	205750000	C16L8L	C13	SM661207103	SM.01uF
A13	SM201186574	SM74AC574	C14	SM661127104	SM.1uF
A14	SM205701070	SRAM128Kx8	C15	SM661255180	SM18pF
A15	SM208470358	SMLM358	C16	SM661255180	SM18pF
A16	SM205219256	SM62256-8	C17	SM661127104	SM.1uF
A17	MDS410	MDS410	C18	SM661127104	SM.1uF
A18	SM200178032	SM74HCT32	C19	SM661127104	SM.1uF
A19	205750000	C16R6L	C20	SM661207103	SM.01uF
A20	SM-NVRAM	SM-NVRAM	C21	SM661127104	SM.1uF
A21	SM207668881	SM68881FN	C22	SM661207103	SM.01uF
A22	EPROM	EPROM	C23	SM661207103	SM.01uF
A23	SM-PSRAM	SM-PSRAM	C24	SM661127104	SM.1uF
A24	205750000	C16R4L	C25	SM661127104	SM.1uF
A25	205750000	C16L8L	C26	SM661127104	SM.1uF
A26	205750000	C16L8L	C28	SM661127104	SM.1uF
A27	EPROM	EPROM	C29	SM661127104	SM.1uF
A28	SM-PSRAM	SM-PSRAM	C30	SM661207103	SM.01uF
A29	EPROM	EPROM	C31	SM661127104	SM.1uF
A30	SM-PSRAM	SM-PSRAM	C32	SM661127104	SM.1uF
A31	205750000	C16L8L	C33	SM661127104	SM.1uF
A32	205750000	C16R4L	C34	SM661127104	SM.1uF
A33	205750000	C16L8L	C35	SM661207103	SM.01uF
A34	205750000	C16L8L	C36	SM661127104	SM.1uF
A35	SM208277770	SMTL7770-5	C37	SM661127104	SM.1uF
A36	SM207178541	SM74HCT541	C38	SM661127104	SM.1uF
A37	SM207178541	SM74HCT541	C39	SM661207103	SM.01uF
A38	EPROM	EPROM	C40	SM661207103	SM.01uF
A39	SM-PSRAM	SM-PSRAM	C41	SM666377226	SM22uF-15V
A40	SM207878245	SM74HCT245	C42	SM661127104	SM.1uF
A41	SM205219265	SM6264-10	C43	SM666377226	SM22uF-15V
A42	SM205219265	SM6264-10	C44	SM661127104	SM.1uF
A43	MNX401	MNX401	C45	SM661127104	SM.1uF
B1	312590070	BAT-2.4V-50	C46	SM661127104	SM.1uF
C1	SM661127104	SM.1uF	C47	SM661127104	SM.1uF

PART: F9314M-1 or F9300-1-2 DESC: PROCESSOR CARD with 2Mb RAM

Location	Part Number	Description	Location	Part Number	Description
C48	SM661207102	SM.001uF	R17	SM652101103	SM10KS
C49	SM666377226	SM22uF-15V	R18	SM652101102	SM1KS
C50	SM661127104	SM.1uF	R20	SM652101103	SM10KS
C51	SM661127104	SM.1uF	R21	SM652101220	SM22S
C52	SM661127104	SM.1uF	R22	SM652101220	SM22S
C53	SM661127104	SM.1uF	R23	SM652101220	SM22S
C54	SM661127104	SM.1uF	R24	SM652101220	SM22S
C55	SM661127104	SM.1uF	R25	SM652101220	SM22S
C56	SM661127104	SM.1uF	R27	SM652101103	SM10KS
C57	SM661255101	SM100pF	R28	SM652101220	SM22S
C60	SM661127104	SM.1uF	R29	SM652101220	SM22S
C61	SM666327225	SM2.2uF-20V	R30	SM652101220	SM22S
C63	SM666377226	SM22uF-15V	R31	SM652101220	SM22S
C64	SM661255101	SM100pF	R32	SM652101152	SM1.5KS
CR1	SM253032823	HSMS2823	R33	SM652101152	SM1.5KS
CR2	SM256232013	SLM-13V	R34	SM652101220	SM22S
CR3	SM236030099	BAV99	R35	SM652101220	SM22S
DR1	NULL	DRILL3_2	R36	SM652101220	SM22S
DR2	NULL	DRILL3_2	R37	SM652101220	SM22S
DR3	NULL	DRILL3_2	R38	SM652101220	SM22S
DR4	NULL	DRILL3_2	R39	SM652101220	SM22S
DR5	NULL	DRILL3_2	R40	SM652101103	SM10KS
J1	455410096	3x32-RA-M-SC	R41	SM652101152	SM1.5KS
J2	455420096	3x32-RA-F-SC	R42	SM652101221	SM220S
J3	404500068	2x34-RA-CGS	R43	SM652101102	SM1KS
J4	454511020	2x10-RA-M-RE	R44	SM652101220	SM22S
J5	454511040	2x20-RA-M-RE	R46	SM652101103	SM10KS
J6	454511014	2x7-RA-M-RE	R47	SM652101103	SM10KS
J7	454340002	2x1-ST-M-NW	R48	SM652101103	SM10KS
L1	SM301502001	SMBEAD1206	R49	SM652101104	SM100KS
Q1	SM270330848	BC848C	R50	SM652101104	SM100KS
Q2	SM270330848	BC848C	R51	SM652101220	SM22S
Q3	SM280171005	MTD10N05E	R52	SM652101104	SM100KS
R3	SM652101101	SM100S	R53	SM652101220	SM22S
R4	SM652101221	SM220S	R54	SM652101152	SM1.5KS
R5	SM652101103	SM10KS	R55	SM652101332	SM3.3KS
R6	SM652101102	SM1KS	RN1	190042103	10K-SIPC
R8	SM652101154	SM150KS	RN2	190642103	10K-6SIPC
R9	SM652101106	SM10MS	RN3	190042103	10K-SC
R10	SM652101101	SM100S	RN4	190042103	10K-SC
R11	SM652101101	SM100S	RN5	190042103	10K-SC
R12	SM652101101	SM100S	RN6	190842102	1K-8SC
R13	SM652101103	SM10KS	RN7	190042103	10K-SIPC
R14	SM652101220	SM22S	RN8	190042103	10K-SIPC
R15	SM652101102	SM1KS	RN9	190042103	10K-SIPC
R16	SM652101511	SM510S	RN10	190042103	10K-SIPC

PART: F9314M-1 or F9300-1-2 DESC: PROCESSOR CARD with 2Mb RAM

Location	Part Number	Description
S1	SM654101000	SM0S-2P
S2	SM654101000	SM0S-2P
S3	SM654101000	SM0S-2P
S4	SM654101000	SM0S-2P
S5	SM654101000	SM0S-2P
S6	SM654101000	SM0S-2P
S7	SM654101000	SM0S-2P
S9	SM654101000	SM0S-2P
S10	SM654101000	SM0S-2P
S11	SM654101000	SM0S-2P
S12	SM654101000	SM0S-2P
T1	NULL	OPEN-SHORT
Y1	SM310300406	SM32.768KHz
Y2	309380016	16.000MHZ
Y3	SM311248000	SMOSC48MHz

PART: F9314M-1 or F9300-1-2 DESC: PROCESSOR CARD with 2Mb RAM

COMPONENT	PART DESCRIPTION	QTY PER ASSEMBLY
190042103	RESISTOR NETWORK 10 K	8
190642103	RESISTOR NETWORK 10 K	1
190842102	RES NETWORK 1 K	1
205370004	IC CMOS UV EPROM 32K X 8 27C	1
205370020 or 205371040	IC UV EPROM CMOS 2MBIT or 4MBIT	4 or 2
205750000	IC AND-OR GATE ARRAY 16V8	9
253010835	DIODE HOT CARRIER HP2835	1
309380016	CRYSTAL OSC (PROGR) 16 MHZ	1
312590070	BATTERY LITHIUM 3V 70MAH	1
400331020	SOCKET IC ST DIP-20	1
400360028	SOCKET IC ST DIP-28	1
400360032	SOCKET IC ST DIP-32	4
404500068	CONN BD TO BD 68 POS	1
454340002	HDR MALE PIN TO WW 02	1
454511014	HDR SOLD TAIL/MALE/14/RT	1
454511020	HDR SOLD TAIL/MALE 20	1
454511040	HDR SOLD TAIL/MALE/40/RT	1
455410096	CONN RT ANGLE MALE 96 S-CLIP	1
550130108	SCREW CYL HD M3X8	2
552130101	NUT HEX M3	2
719300103	PC BD PREASS'Y 9300-1 F	1
MDS410	IC RSDP GATE ARRAY MDS410	1
MNX401	ICMIN MAX GATEARR. MNX401	1
SM200178032	IC 2-IN OR HCT32	2

PART: F9314M-1 or F9300-1-2 DESC: PROCESSOR CARD with 2Mb RAM

COMPONENT	PART DESCRIPTION	QTY PER ASSEMBLY
-----	-----	-----
SM200276068	IC RTC SERIAL 68HC68T1	1
SM201186574	IC OCTAL D-TYP FLOP 74AC574	1
SM205219256	IC 32K X 8 SRAM MS62256	1
SM205219264	IC 8K X 8 SRAM 70 NSEC 6264	3
SM205290512	IC 512K X 8 PSRAM HM658512	4
SM205701070	IC 128KX8 STAT RAM 70 NS	1
SM207178541	IC BUFFER/LINE DR HCT541	6
SM207260475	IC RAMDAC 256W 50MHZ BT475	1
SM207668020	IC 32-BIT U-PROC 68020	1
SM207668881	IC CO-PROCESSOR 68881	1
SM207878245	IC BUS TRANSCVR HCT 245	2
SM208277770	IC DUAL PWR SUPPLY SUP 7770-5	1
SM208470358	IC DUAL OP AMP 358D	1
SM236030099	DIODE SO-PKG BAV99	1
SM253032823	DIODE SCHOTTKY 2823	1
SM256232013	DIODE LIGHT EMITTING RED	1
SM270330848	TRANSISTOR NPN BC848C	2
SM280171005	TRANS POWER MOSFET MTD10N05E	1
SM301502001	BEAD (FERRITE CHIP)	1
SM310300406	CRYSTAL 32768HZ	1
SM311248000	CRYSTAL OSCILLATOR 48MHZ	1
SM652101101	RES CHIP (E24) 1% 100 OHM	4
SM652101102	RES CHIP (E24) 1% 1 K	4
SM652101103	RES CHIP (E24) 1% 10 K	9
SM652101104	RES CHIP (E24) 1% 100 K	3
SM652101106	RES CHIP (E24) 1% 10 MEG	1
SM652101152	RES CHIP (E24) 1% 1.5 K	4
SM652101154	RES CHIP (E24) 1% 150 K	1
SM652101220	RES CHIP (E24) 1% 22 OHMS	19
SM652101221	RES CHIP (E24) 1% 220 OHM	2
SM652101332	RES CHIP (E24) 1% 3.3 K	1
SM652101511	RES CHIP (E24) 1% 510 OHM	1
SM654101000	CHIP JUMPER ZERO OHMS	11
SM661127104	CAP CERA CHIP 20% .1 UF	40
SM661207102	CAP CERA CHIP 10% .001UF	1
SM661207103	CAP CERA CHIP 20% .01UF (0805)	9
SM661255101	CAP CERA CHIP 5% 100 PF	2
SM661255180	CAP CERA CHIP 5% 18PF	2
SM666217106	CAP MOLD TANT CHIP 10 UF	1
SM666327225	CAP MOLD TANT CHIP 2.2 UF	1
SM666377226	CAP MOLD TANT CHIP 22 UF	4

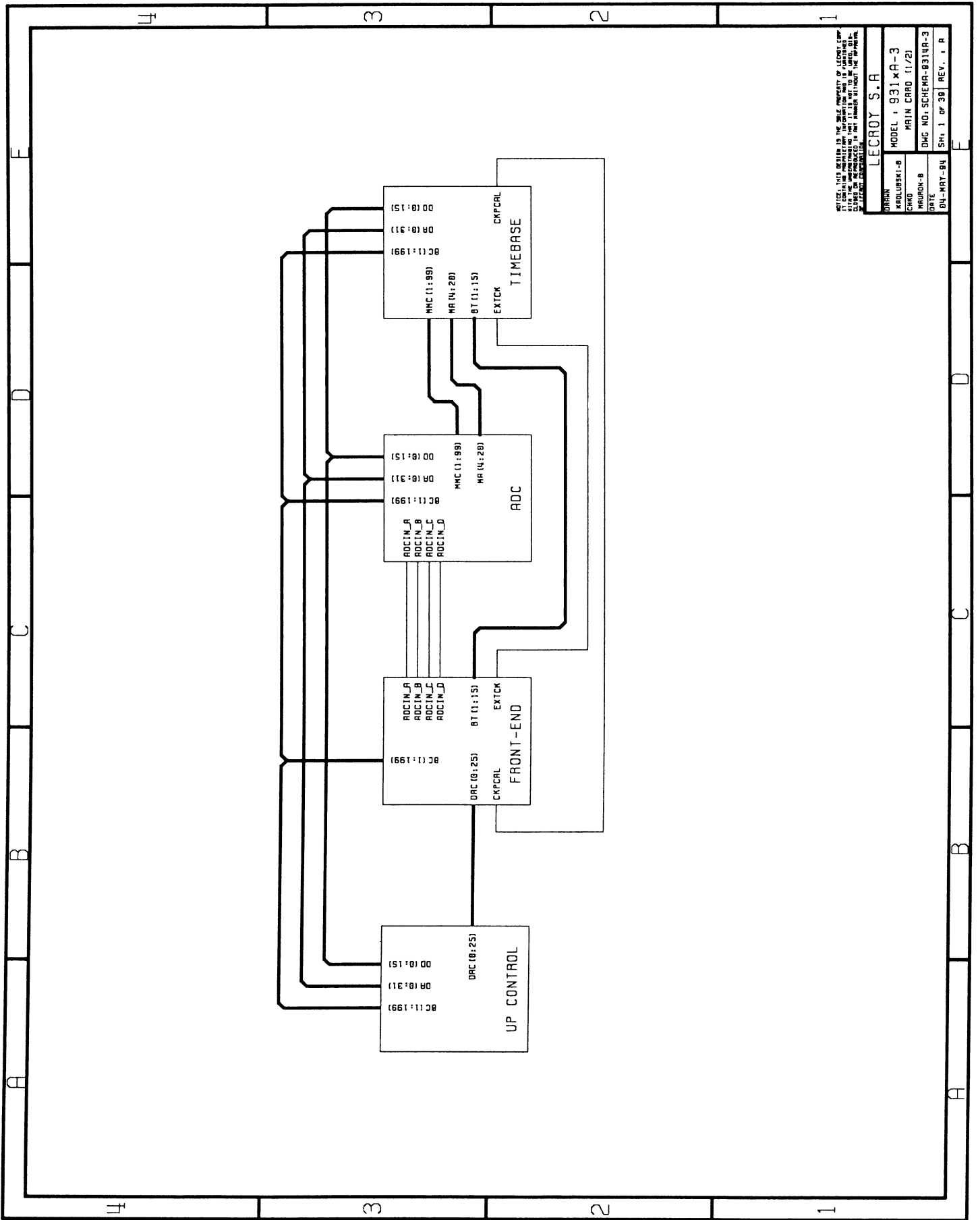

Section 8 Schematics, Layouts, Parts list

A		B		C		D		E	
ADC MEMORY :		9310AS	9310A	9310AM	9310AL	9314AS	9314A	9314AM	9314AL
		16x 2Kx8	16x 8Kx8	16x 32Kx8	16x 128Kx8	32x 2Kx8	32x 8Kx8	32x 32Kx8	32x 128Kx8
UNMOUNTED COMPONENT :		9310AS	9310A-AM-AL	9314AS	9314A	9314AS	9314A	9314AM	9314AL
FE / ADC CHANNELS :		A & B	A & B	A206	A206	A224	A224	A205-A207 A212-A217 A211	none A203-A206 A224
PSRAM 512Kx8 (ADC SHEET1)		A203-A206	A206	A206	A206	A224	A224	A205-A207 A212-A217 A211	none A203-A206 A224
MIN-MAX MNX401 (ADC SHEET1)		A203-A206	A206	A206	A206	A224	A224	A205-A207 A212-A217 A211	none A203-A206 A224
ADDRESS COUNTER SM74HCT191 (ADC SHEET3)		A203-A206	A206	A206	A206	A224	A224	A205-A207 A212-A217 A211	none A203-A206 A224
GAL 16V8A - "CORNAC" (uP SHEET2)		A10	A10	A10	A10	A10	A10	A10	A10
SM74HCT541+SM74HCT245 (ADC SHEET3)		A222-A204-A218	A222-A204-A218	A222-A204-A218	A222-A204-A218	A222-A204-A218	A222-A204-A218	A222-A204-A218	A222-A204-A218
SMLF347 (FE SHEET1)		A101	A101	A101	A101	A101	A101	A101	A101
SMDG201 (FE SHEET1)		A102	A102	A102	A102	A102	A102	A102	A102
SM.01uF-NPO (FE SHEET1)		C100-C101-C104-C105	C100-C101-C104-C105	C100-C101-C104-C105	C100-C101-C104-C105	C100-C101-C104-C105	C100-C101-C104-C105	C100-C101-C104-C105	C100-C101-C104-C105
SM10KS (FE SHEET1)		R100-R101-R102-R103	R100-R101-R102-R103	R100-R101-R102-R103	R100-R101-R102-R103	R100-R101-R102-R103	R100-R101-R102-R103	R100-R101-R102-R103	R100-R101-R102-R103
SM.01uFS (FE SHEET2)		C102-C103-C106-C107	C102-C103-C106-C107	C102-C103-C106-C107	C102-C103-C106-C107	C102-C103-C106-C107	C102-C103-C106-C107	C102-C103-C106-C107	C102-C103-C106-C107
SM.01uFS (ADC SHEET4)		C207-C225-C452	C207-C225-C452	C207-C225-C452	C207-C225-C452	C207-C225-C452	C207-C225-C452	C207-C225-C452	C207-C225-C452
220-6SIPC (TB SHEET2)		RN400	RN400	RN400	RN400	RN400	RN400	RN400	RN400
SM68S (TB SHEET2)		R532-R542-R572-R573	R532-R542-R572-R573	R532-R542-R572-R573	R532-R542-R572-R573	R532-R542-R572-R573	R532-R542-R572-R573	R532-R542-R572-R573	R532-R542-R572-R573
SM20S (TB SHEET2)		R569-R571-R602-R603	R569-R571-R602-R603	R569-R571-R602-R603	R569-R571-R602-R603	R569-R571-R602-R603	R569-R571-R602-R603	R569-R571-R602-R603	R569-R571-R602-R603

NOTICE: THIS DRAWING IS THE SOLE PROPERTY OF LECROY CORPORATION. IT CONTAINS PROPRIETARY INFORMATION AND IS UNCLASSIFIED. IT IS TO BE CONTROLLED AND DISTRIBUTION IS RESTRICTED TO THE PERSONNEL WITH THE PROPER AUTHORITY.

LECROY S.A.

MODEL : 931xA-3
 MAIN CARD (2/2)
 DWG NO: SCHEMA-931A-3
 SH: 2 of 38 REV. : R

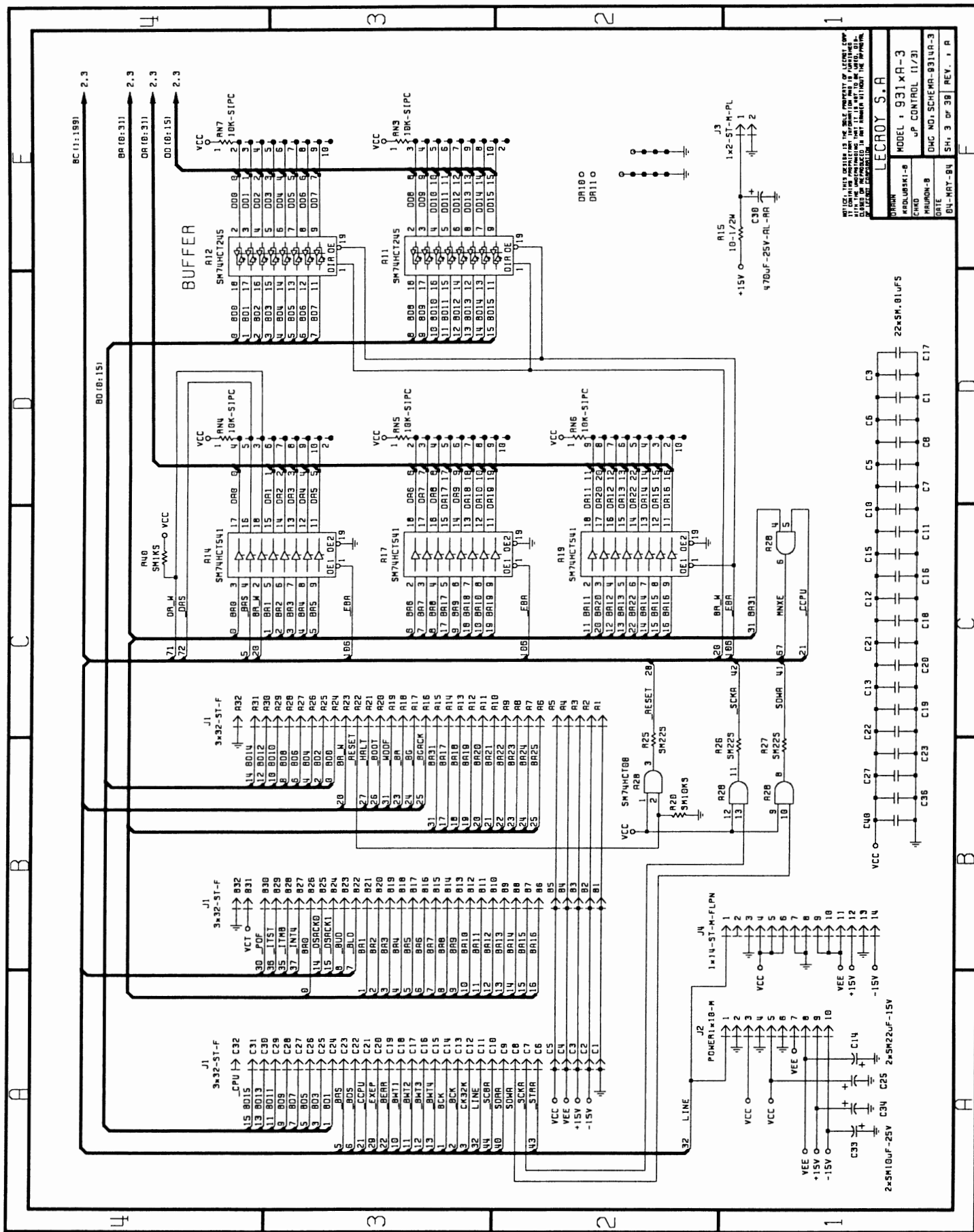

NOTICE: THIS DESIGN IS THE SOLE PROPERTY OF LECROY CORP. IT IS THE PROPERTY OF LECROY CORP. AND IS NOT TO BE REPRODUCED, COPIED, OR TRANSMITTED IN ANY MANNER WITHOUT THE WRITTEN PERMISSION OF LECROY CORP.

LECROY S.A.
MODEL : 931xR-3
CPU CONTROL (I/23)
DRAWN :
CHECKED :
DATE :
REV. : A

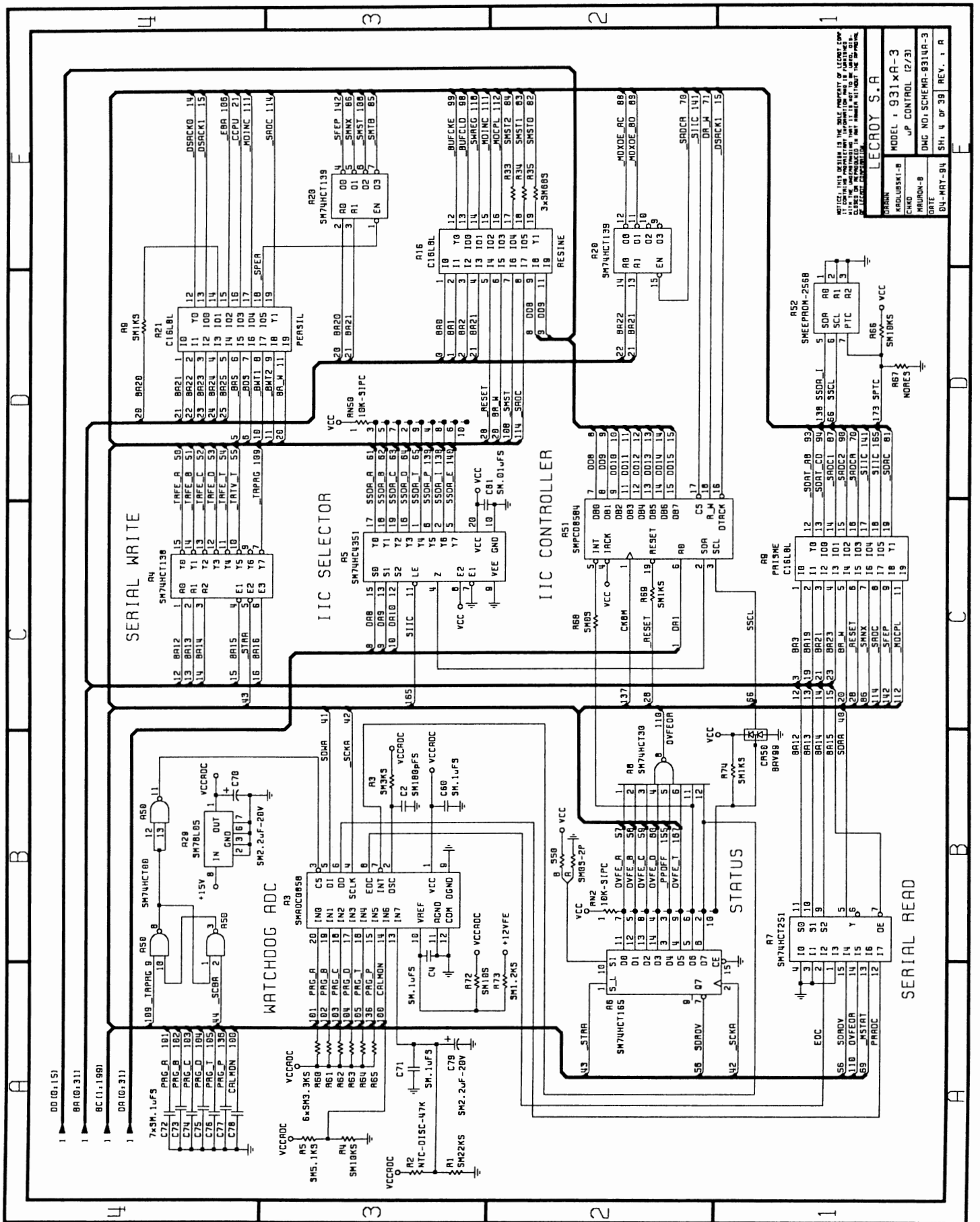

NOTICE: THIS DESIGN IS THE SOLE PROPERTY OF LECROY CORP. ALL RIGHTS ARE RESERVED. THIS DOCUMENT IS UNCLASSIFIED AND IS NOT TO BE REPRODUCED OR TRANSMITTED IN ANY FORM OR BY ANY MEANS, ELECTRONIC OR MECHANICAL, INCLUDING PHOTOCOPYING, RECORDING, OR BY ANY INFORMATION STORAGE AND RETRIEVAL SYSTEM.

LECROY S.A.
 MODEL : 931xA-3
 UP CONTROL (2/23)
 DMC NO: SCHEMA-8314A-3
 REV. 1. A

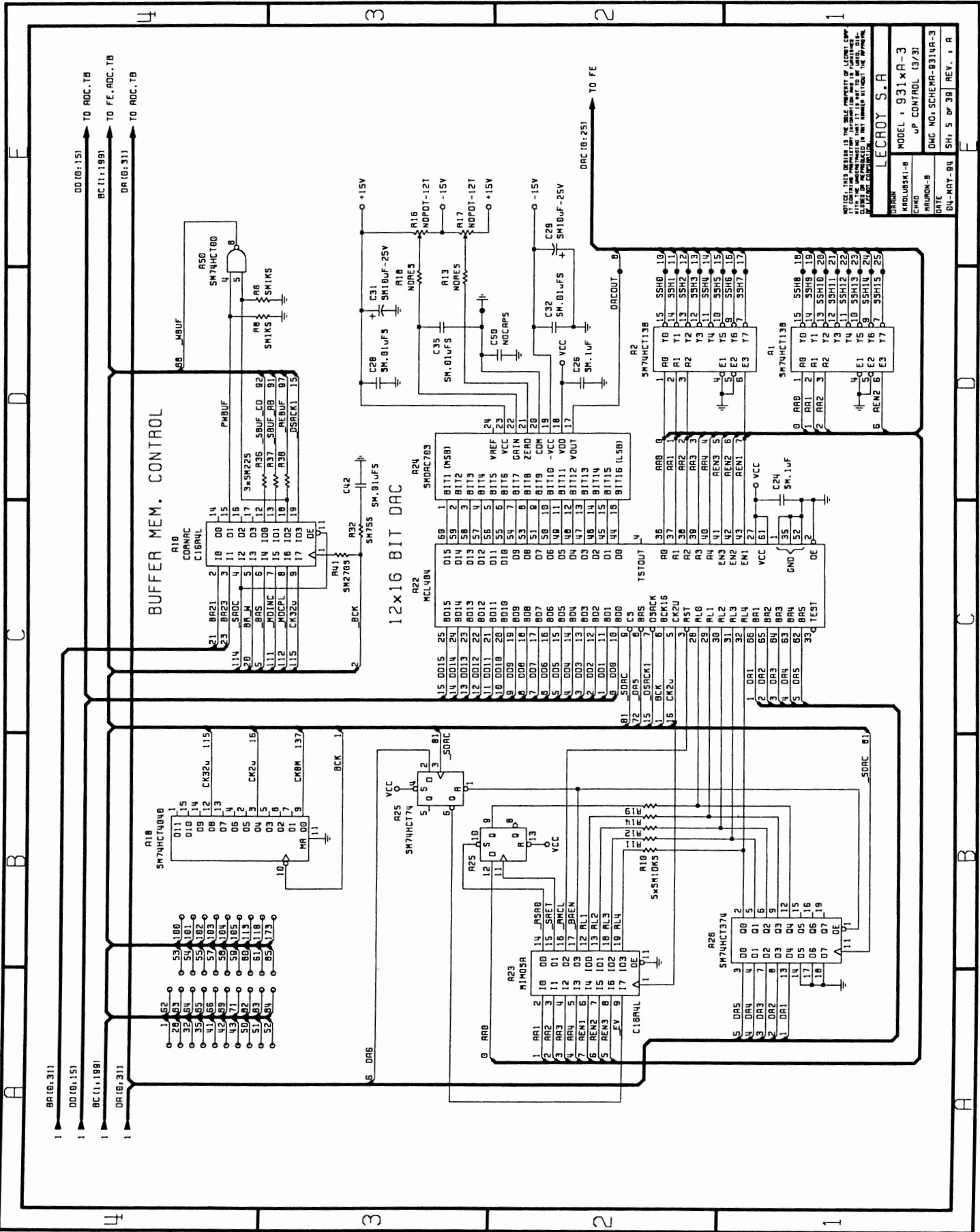

NOTICE: THIS DRAWING IS THE SOLE PROPERTY OF ALLENBY CORP. ALL RIGHTS ARE RESERVED. THIS DRAWING IS TO BE USED ONLY FOR THE PROJECT SPECIFICALLY IDENTIFIED HEREON. NO PARTS TO BE REPRODUCED FOR OTHER PROJECTS.

LECROY S.A.

MODEL : 931xA-3
UP CONTROL (3/91)
DHC NO. SCHEMA-931A-3
REV. 1 A

Section 8 Schematics, Layouts, Parts list

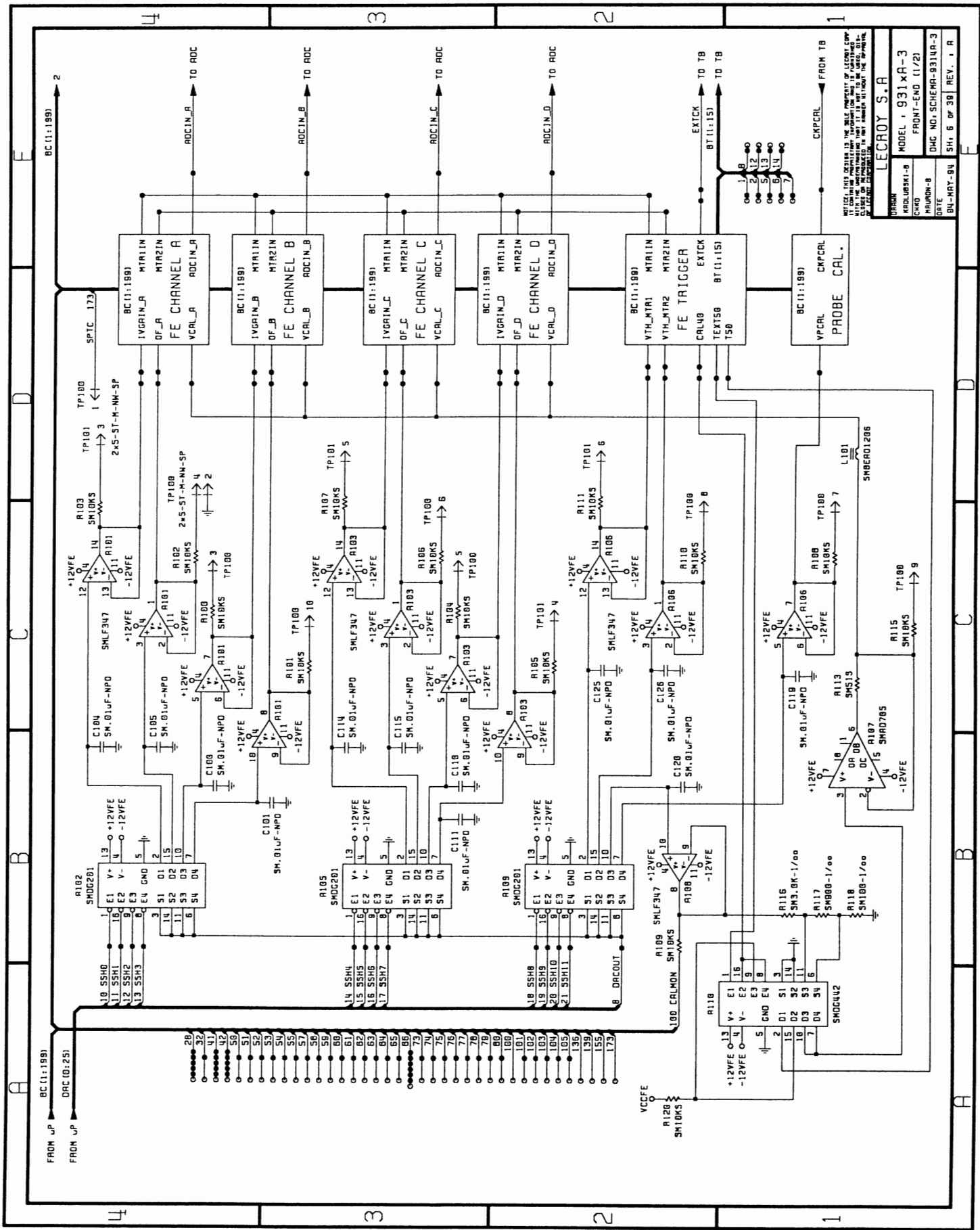

LECRYO S.A

URBAN	MODEL : 931 xA-3
FRONT-LEFT	FRONT-END (1/2)
FRONT-RIGHT	DWG NO: SCHEMA-931A-3
DATE	SH: 6 OF 39 REV. : A

NOTICE: THIS DRAWING IS THE SOLE PROPERTY OF LECRYO S.A. IT CONTAINS THE PROPRIETARY INFORMATION OF LECRYO S.A. AND IS TO BE USED ONLY FOR THE MANUFACTURE OF THE EQUIPMENT SPECIFIED IN THE DRAWING. IT IS NOT TO BE REPRODUCED OR TRANSMITTED IN ANY FORM OR BY ANY MEANS, ELECTRONIC OR MECHANICAL, INCLUDING PHOTOCOPYING, RECORDING, OR BY ANY INFORMATION STORAGE AND RETRIEVAL SYSTEM.

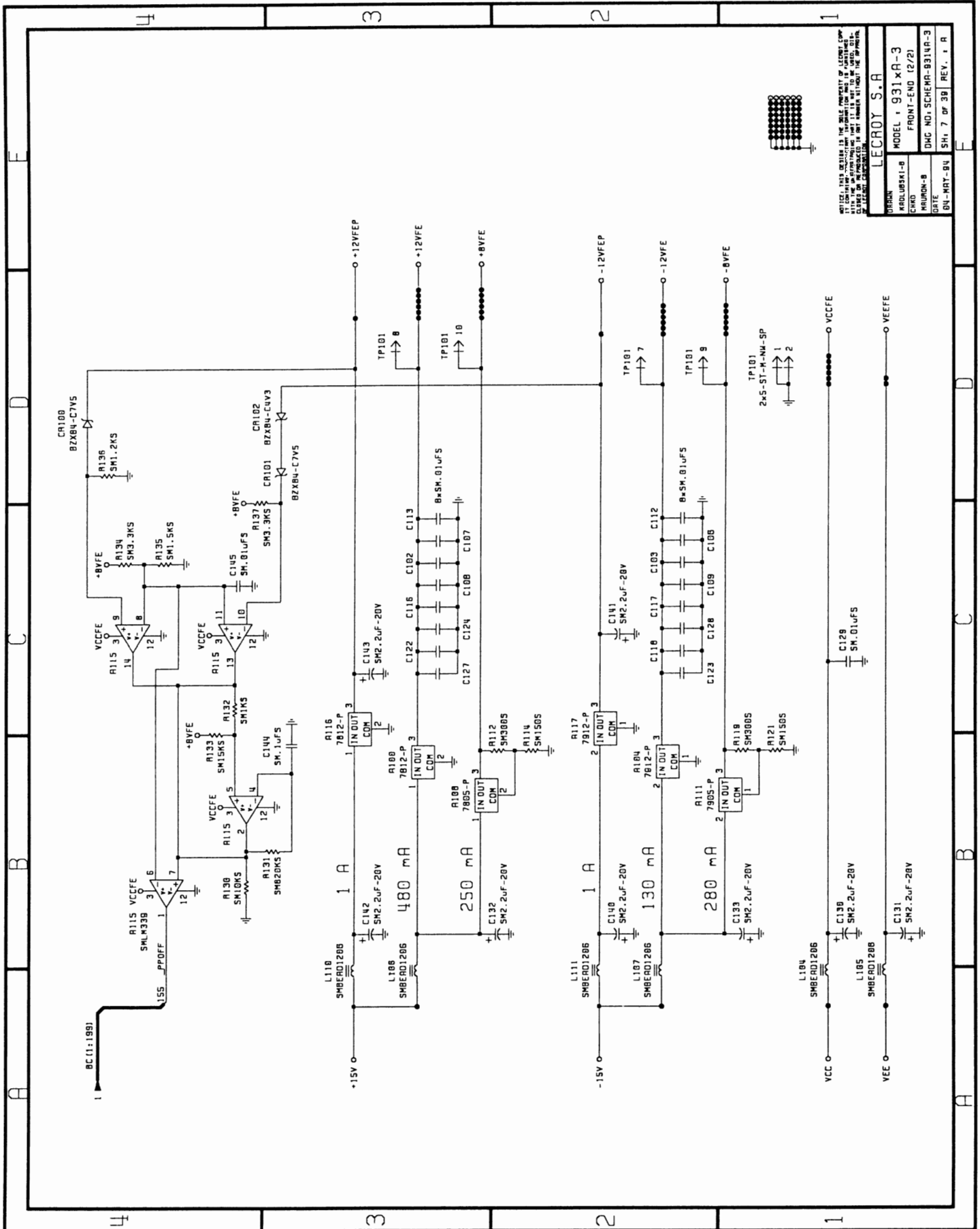

NOTICE: THIS DESIGN IS THE SOLE PROPERTY OF LECROY CORP. ALL RIGHTS RESERVED. PART 11 IS NOT TO BE USED, COPIED, REPRODUCED, OR TRANSMITTED IN ANY FORM OR BY ANY MEANS WITHOUT PERMISSION.

VERSION	LECROY S.A.
MODEL	931XA-3
FRONT-END	12/21
DWG NO.	SCHEM-8314A-3
DATE	
BY	
CHK	
APP	
REV.	1 A

Section 8 Schematics, Layouts, Parts list

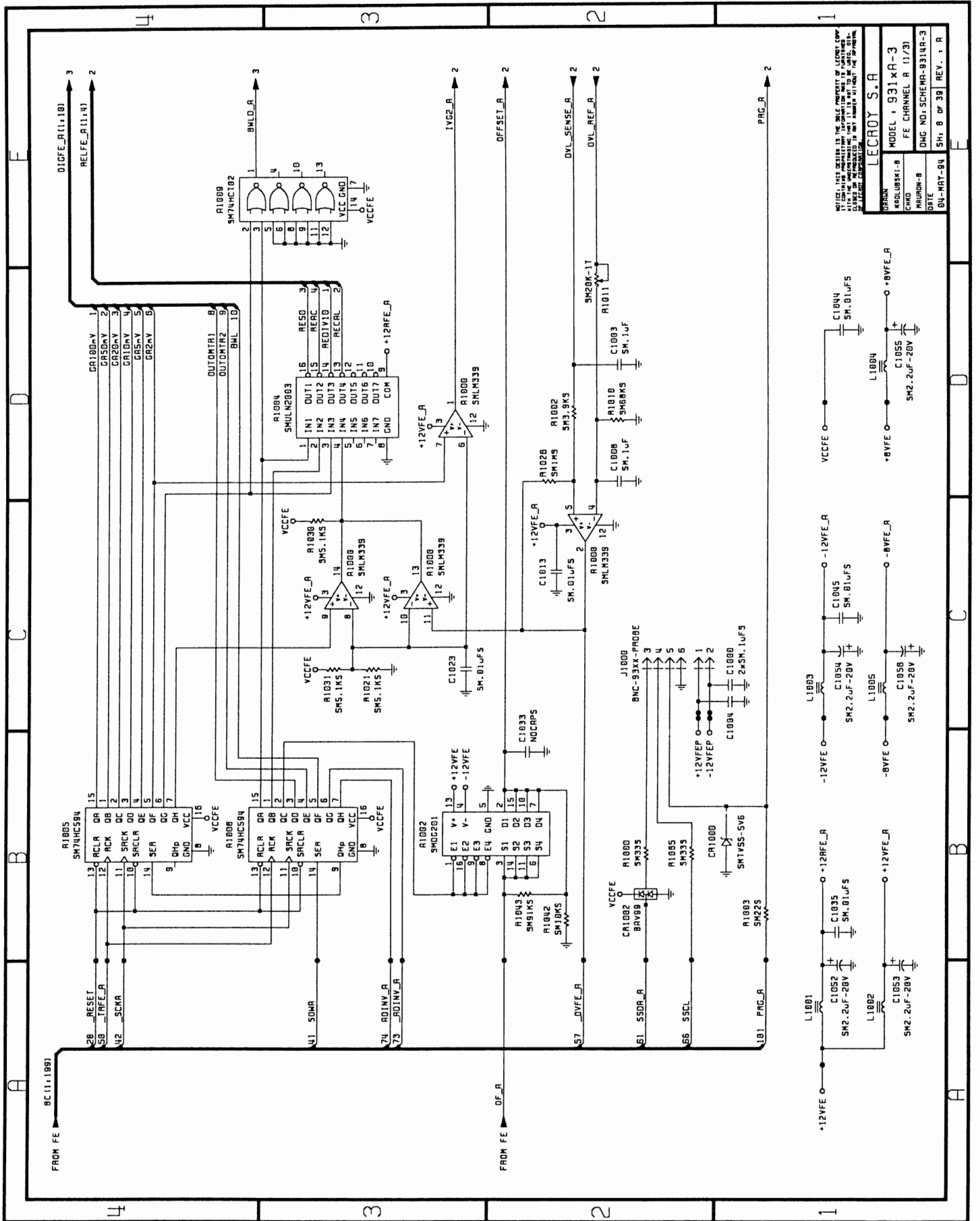

NOTICE: THIS DESIGN IS THE SOLE PROPERTY OF LECROY CORPORATION. ALL RIGHTS ARE RESERVED. NO PART IS TO BE REPRODUCED, COPIED, OR TRANSMITTED IN ANY FORM OR BY ANY MEANS, WITHOUT THE WRITTEN PERMISSION OF LECROY CORPORATION.

DRWNR	LECROY S.A
MODEL	931 XA-3
FE CHANNEL	A (1/3)
DATE	
REV.	8 OF 30

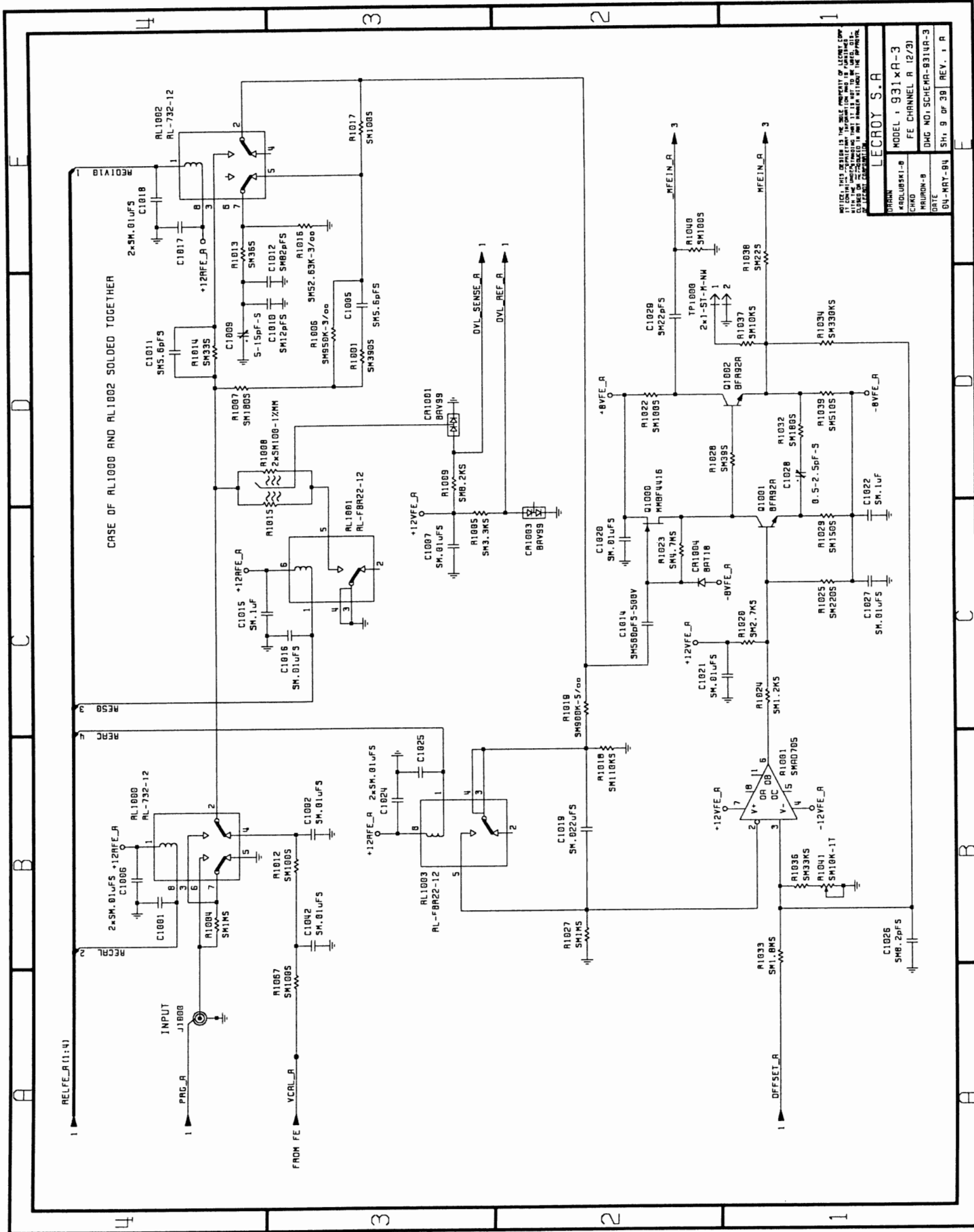

NOTICE: THIS DESIGN IS THE SOLE PROPERTY OF LECROY COMPANY. IT IS THE USER'S RESPONSIBILITY TO OBTAIN THE NECESSARY RIGHTS TO ANY THIRD PARTY PATENTS OR TRADEMARKS THAT MAY BE APPLIED TO THIS DESIGN OR TO THE PRODUCTS OF THIS DESIGN.

DRWNR	LECROY, S.A.
MODEL	931 xA-3
FE CHANNEL	R (2/3)
CHKD	RAUDON-B
DWG NO.	SCHEMA-831VR-3
DATE	SH, 9 OF 30 REV. 1.1 R
BY	SH-MRY-84

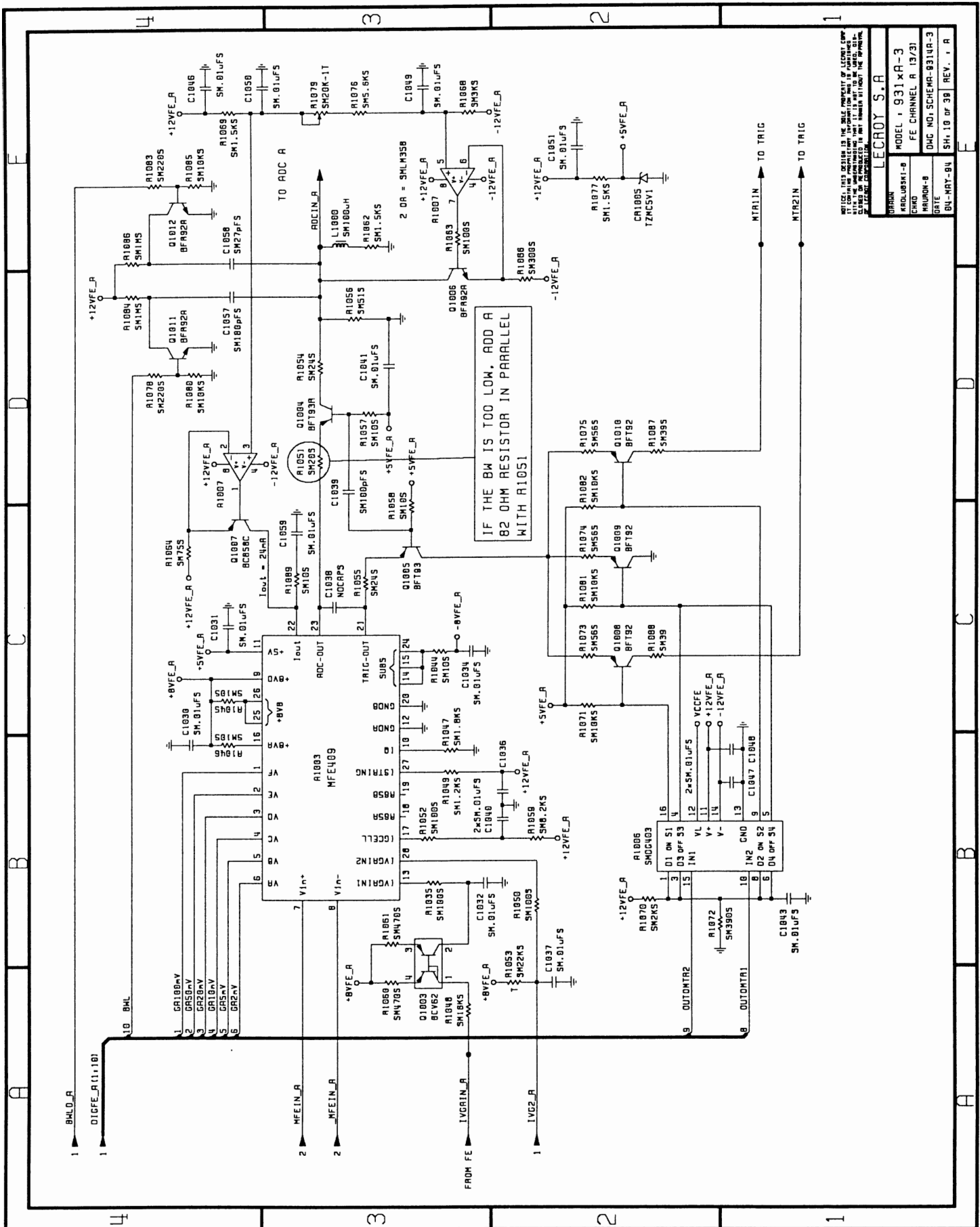

NOTICE: THIS DESIGN IS THE SOLE PROPERTY OF LECROY CORP. IT IS TO BE USED ONLY FOR THE PURPOSES INTENDED AND IS NOT TO BE REPRODUCED OR TRANSMITTED IN ANY FORM OR BY ANY MEANS WITHOUT THE WRITTEN PERMISSION OF LECROY CORP.

DRAWN	KADLOBSKI-B
MODEL	9317A-3
CHKD	FE CHANNEL A 13/31
APPROV	HRUMON-B
DATE	SH-10 OF 38
REV.	1 R

LECROY S.A.

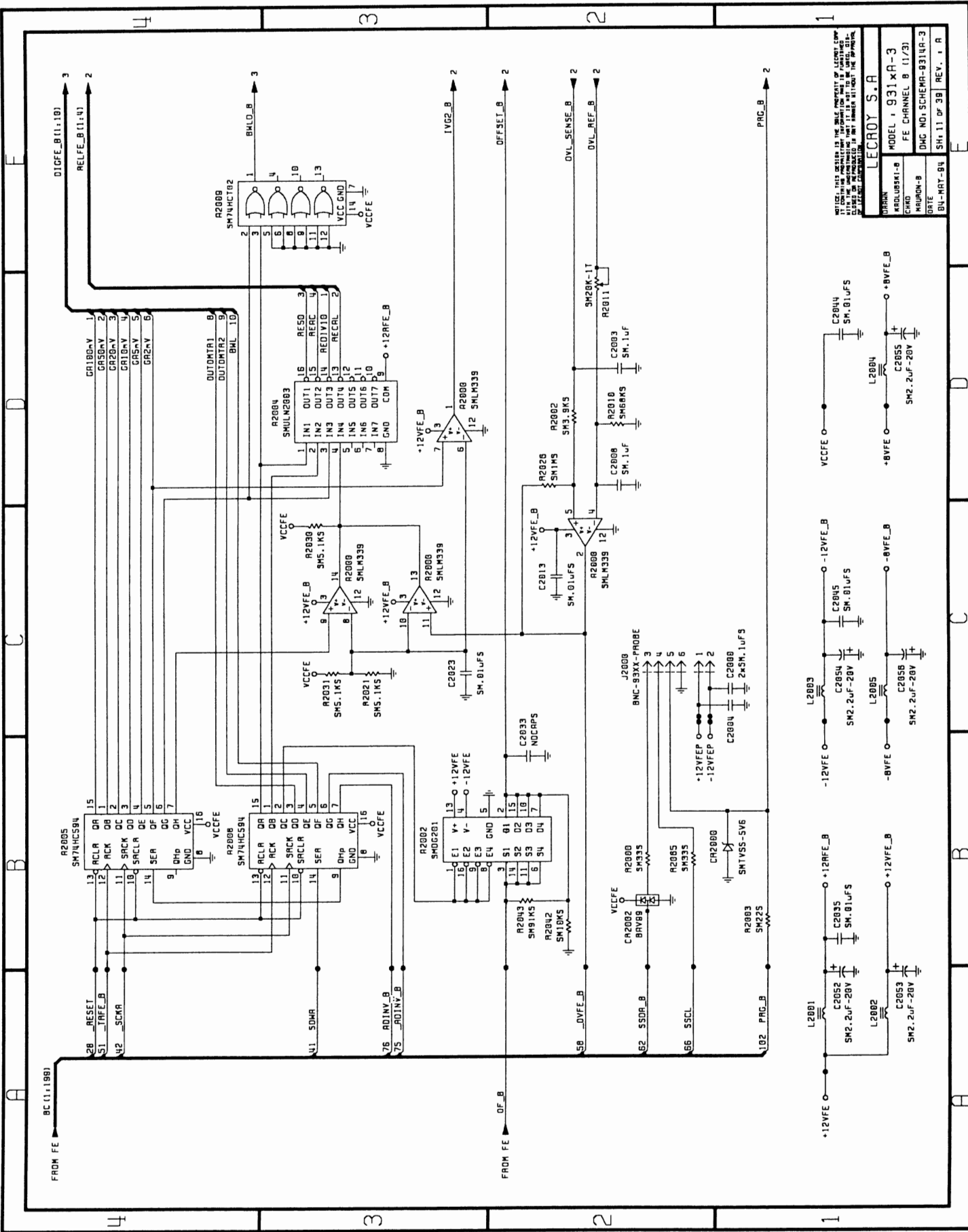

LECROY S.A

DRWNN	MODEL 931XA-3
AROLDUBSKI-B	FE CHANNEL B (1/3)
CMND	DWG NO. SCHEM-831AR-3
MAURON-B	DATE
BU-MAT-84	SH 11 OF 38 REV. 1 A

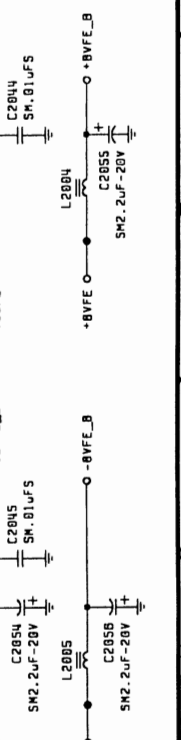

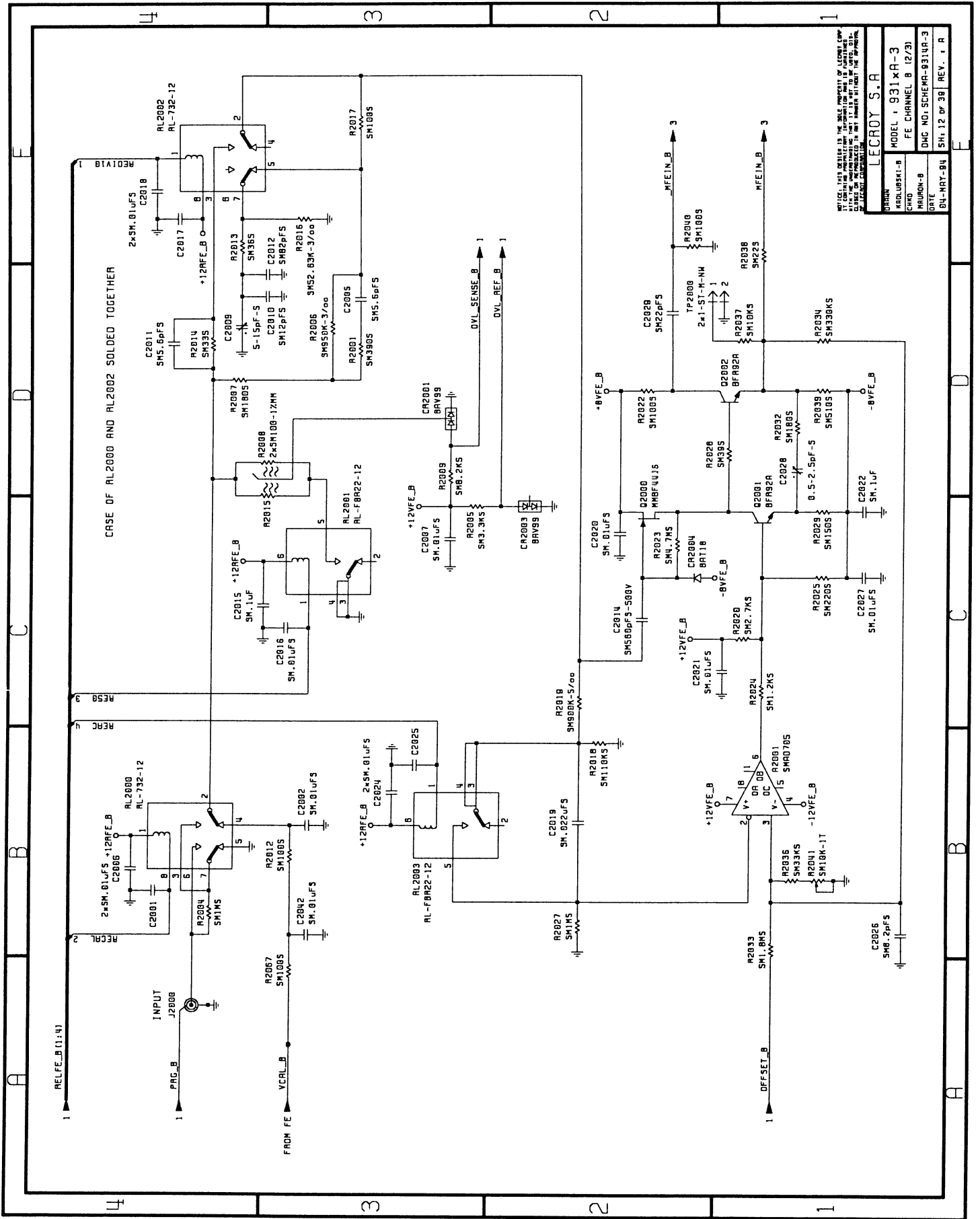

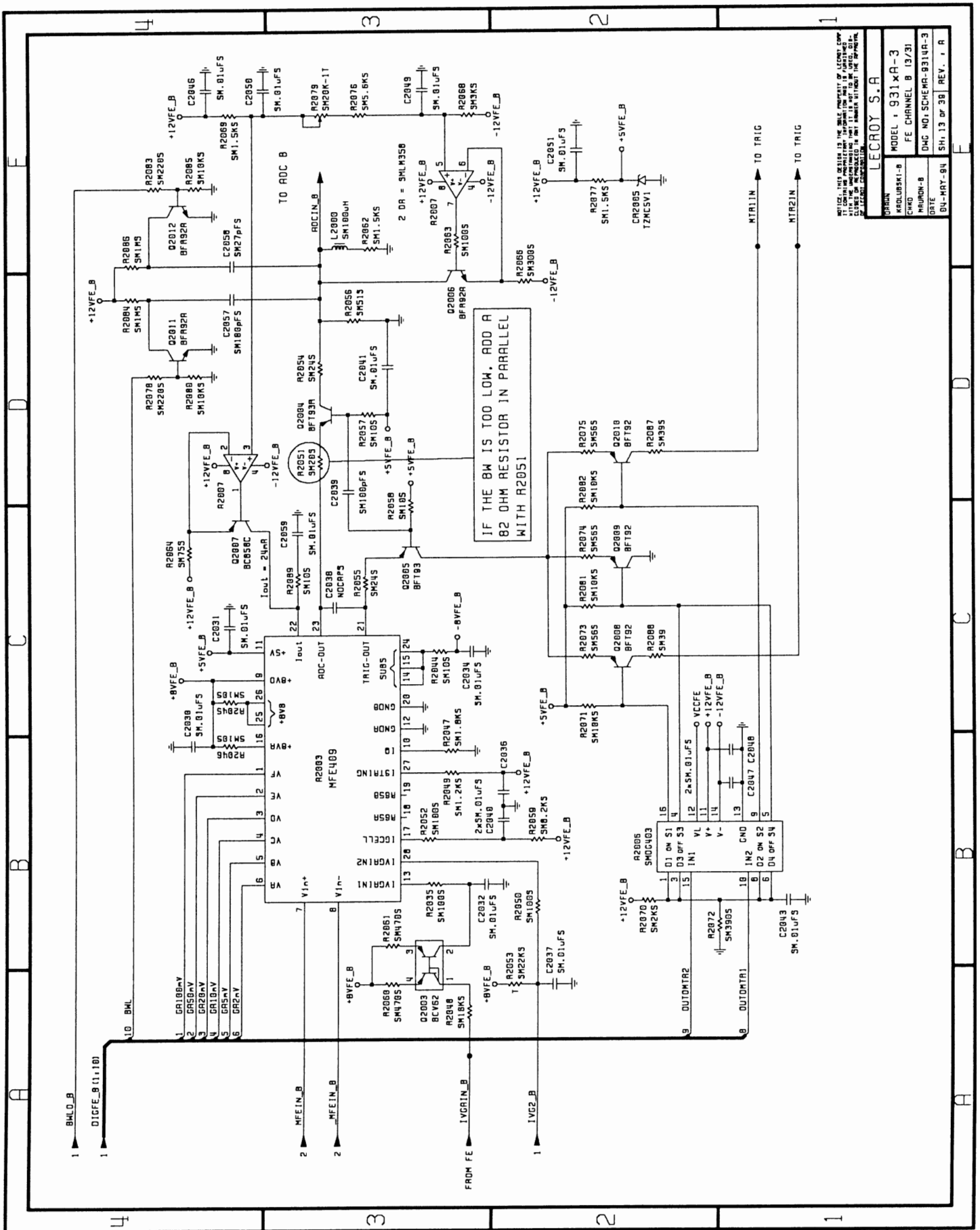

NOTICE: THIS DESIGN IS THE PROPERTY OF LECROY CORP. ALL RIGHTS RESERVED. THIS DESIGN IS NOT TO BE REPRODUCED OR TRANSMITTED IN ANY FORM OR BY ANY MEANS, ELECTRONIC OR MECHANICAL, INCLUDING PHOTOCOPYING, RECORDING, OR BY ANY INFORMATION STORAGE AND RETRIEVAL SYSTEM.

DRWEN	LECROY S.A.
MODEL	931XA-3
FE CHANNEL B	13/31
DATE	04-MAY-84
REV.	1 A

Section 8 Schematics, Layouts, Parts list

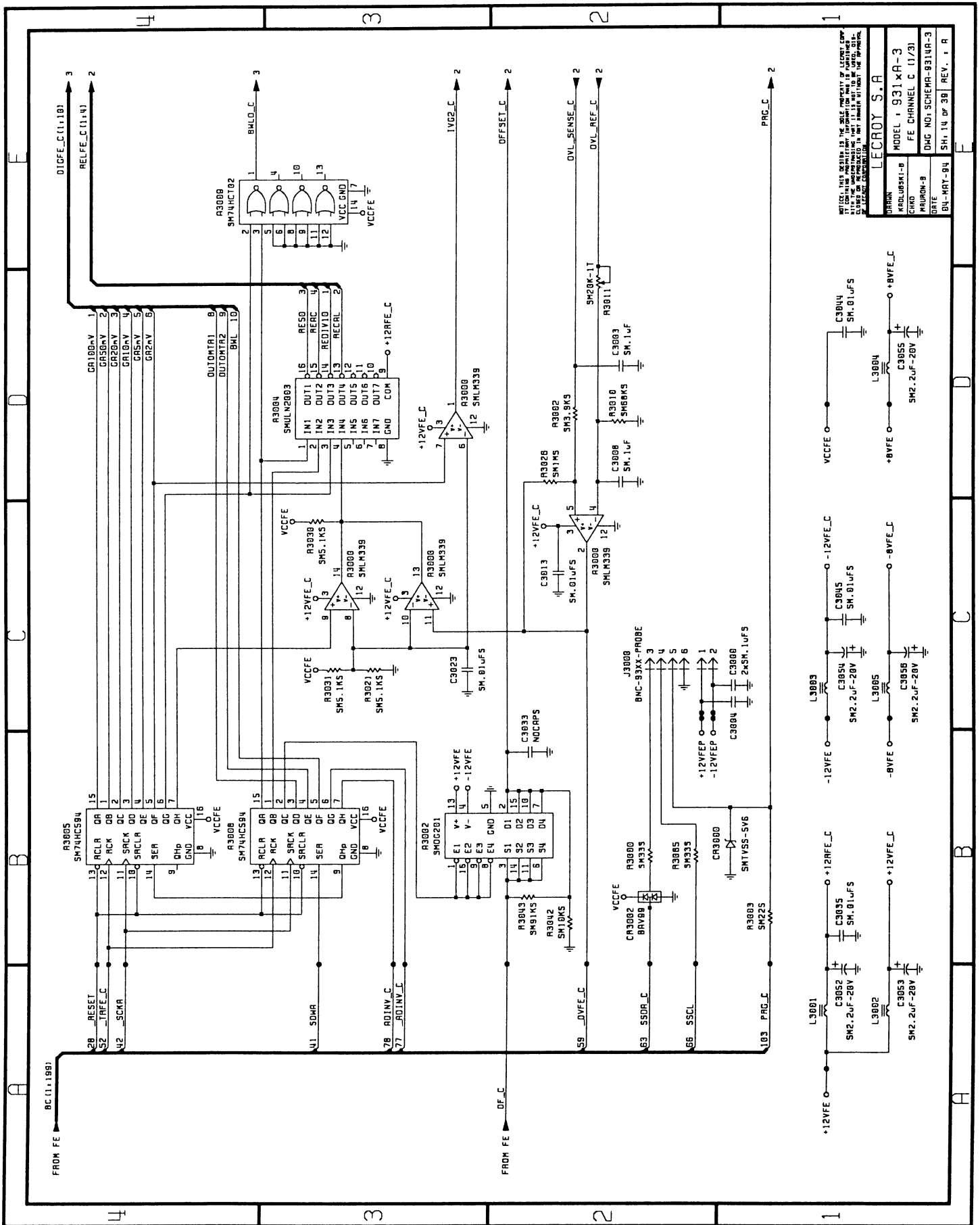

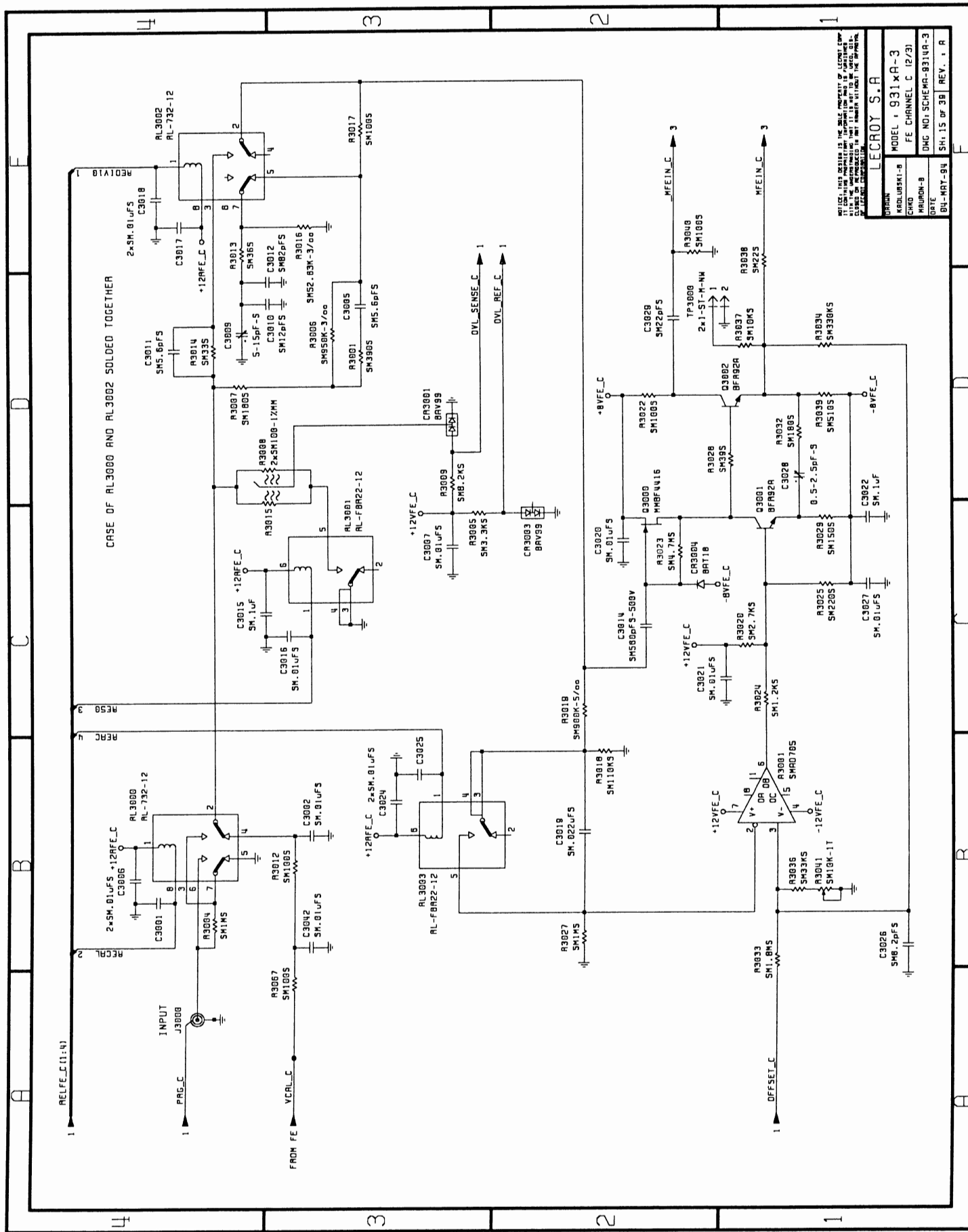

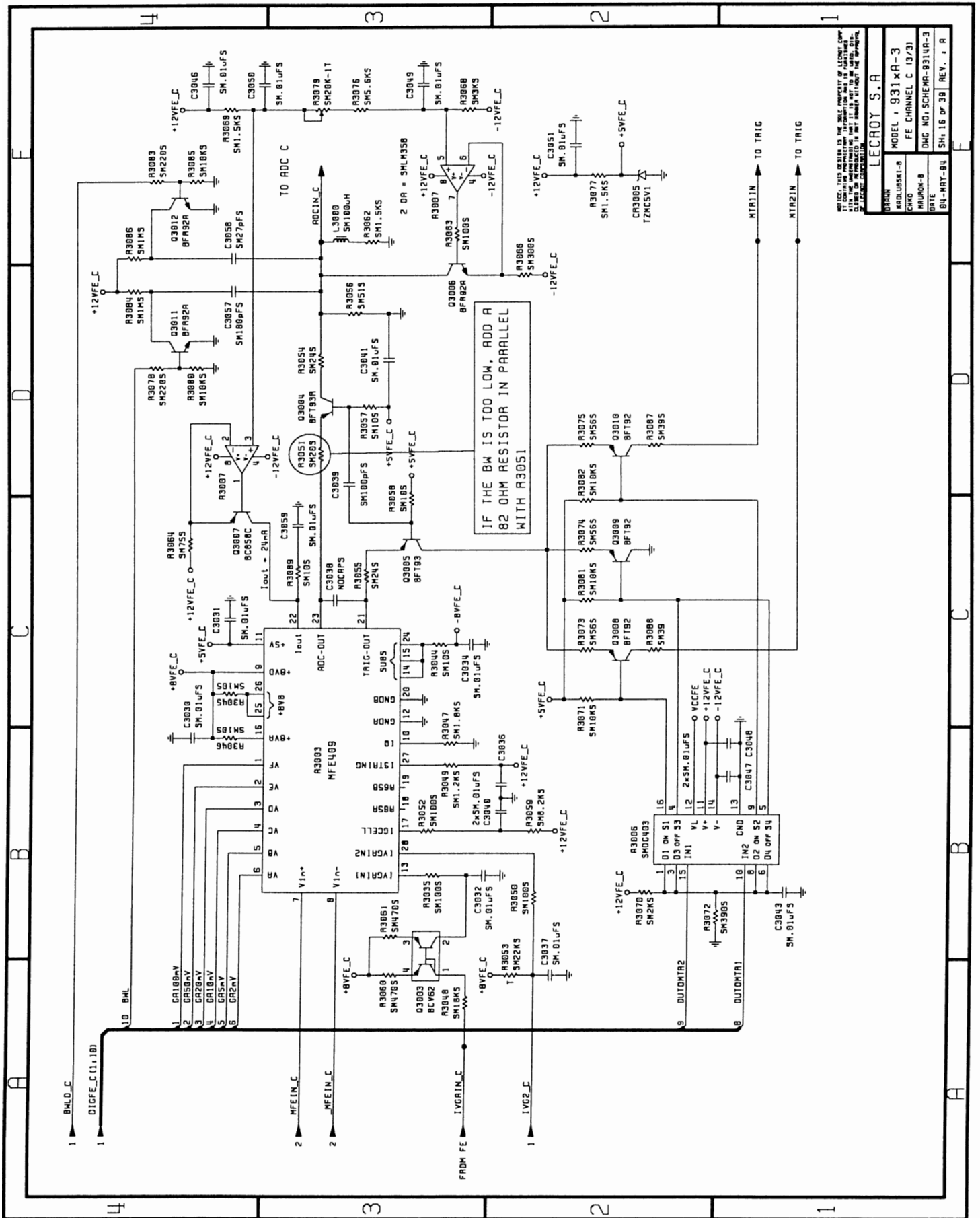

NOTICE: THIS DRAWING IS THE SOLE PROPERTY OF LECROY CORP. IT IS TO BE USED ONLY FOR THE MANUFACTURE OF THE INSTRUMENTS IDENTIFIED HEREIN. IT IS NOT TO BE REPRODUCED, COPIED, OR TRANSMITTED IN ANY FORM OR BY ANY MEANS, WITHOUT THE WRITTEN PERMISSION OF LECROY CORP.

ORGAN	LECROY S.A.
MODEL	931xA-3
FE CHANNEL C	13/31
DWG NO.	SCHEMA-8314A-3
DATE	84-MAY-84
REV.	1 R

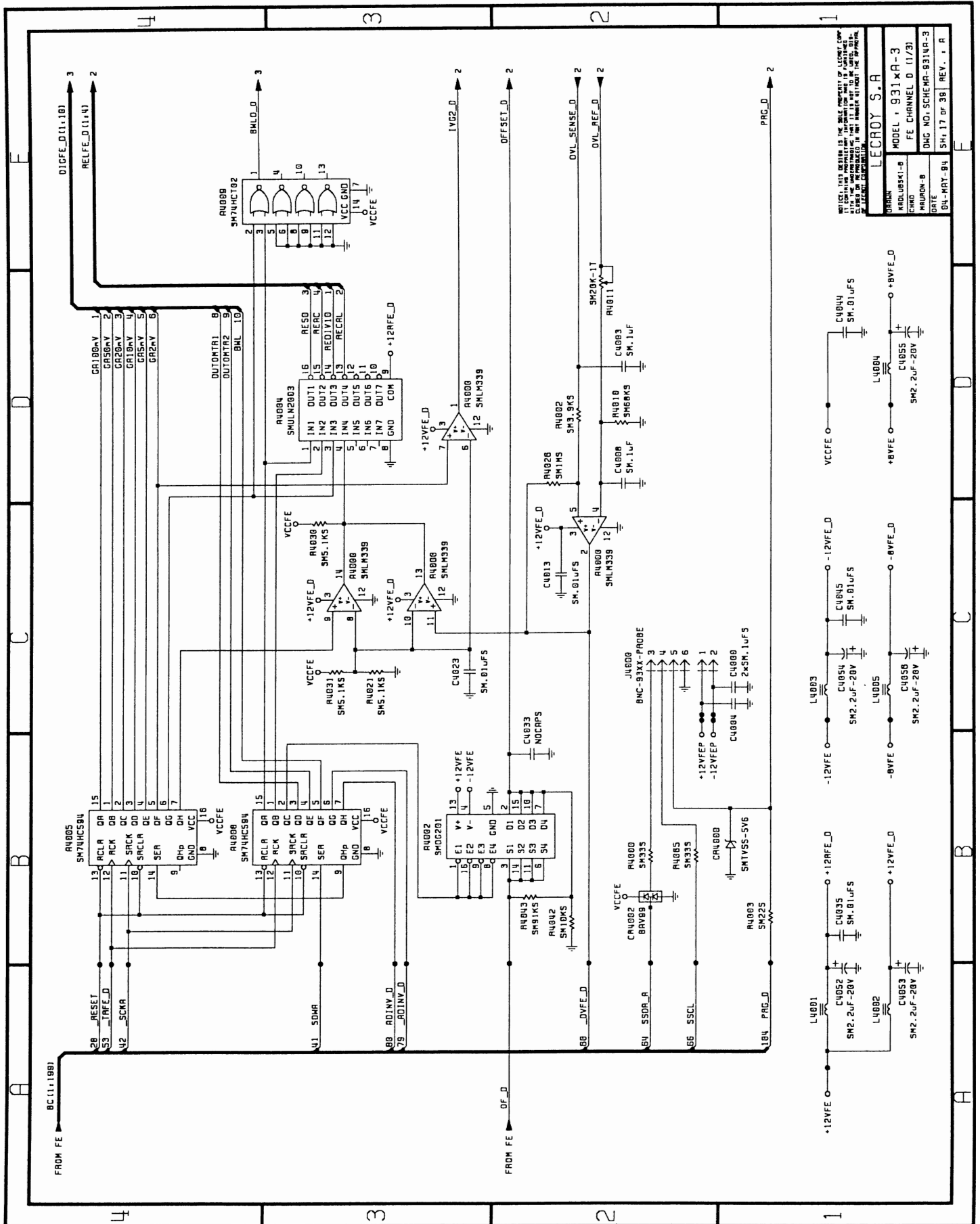

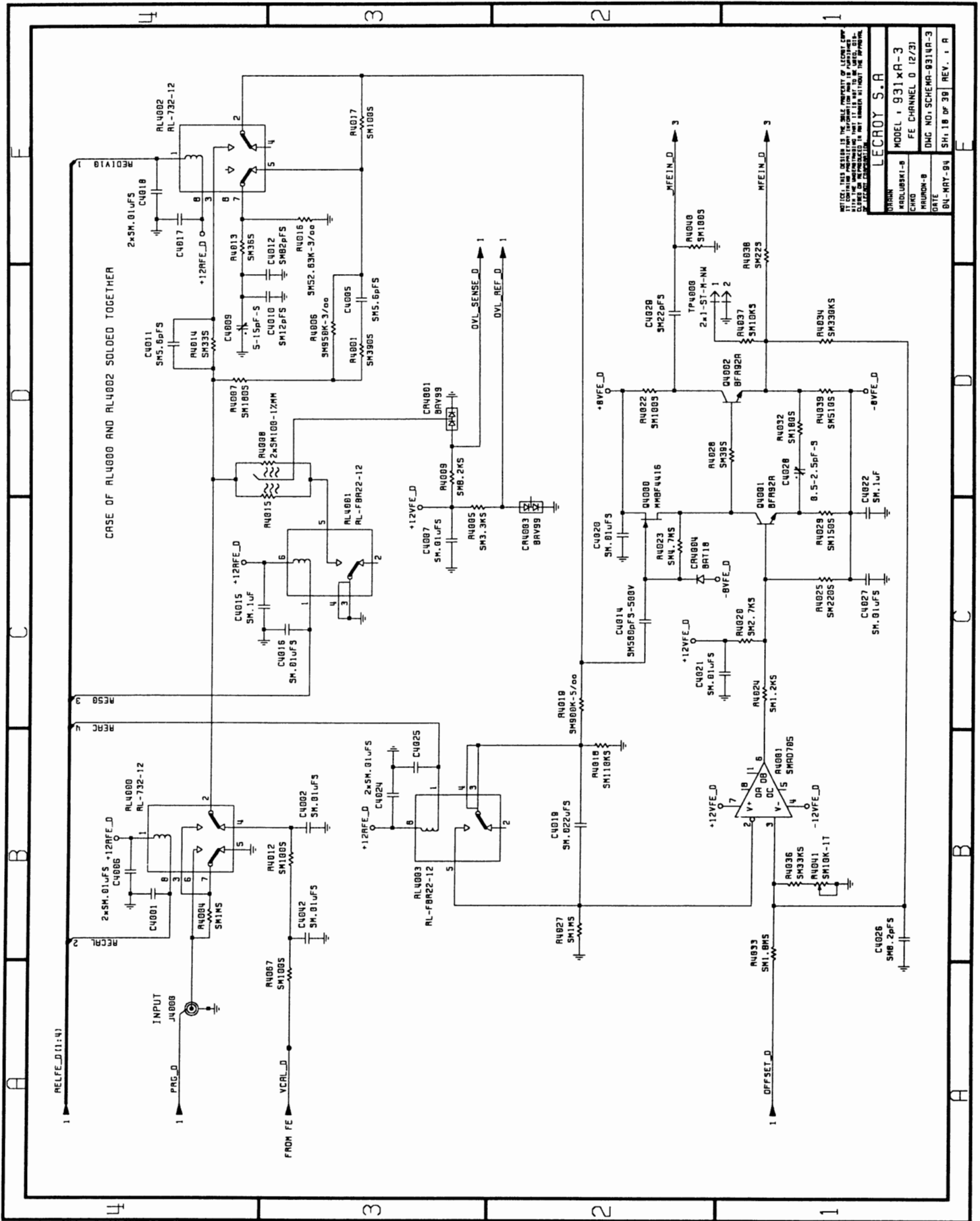

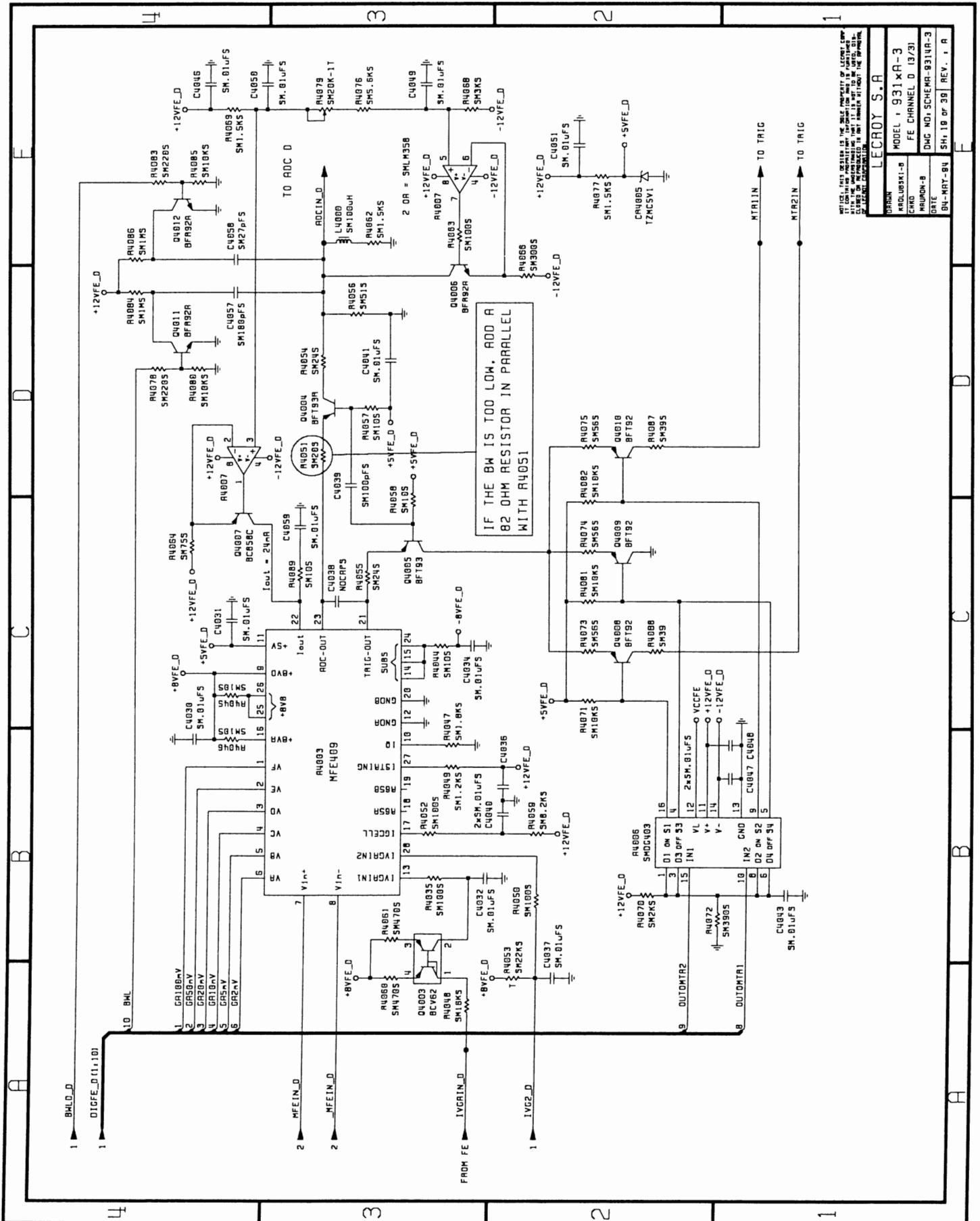

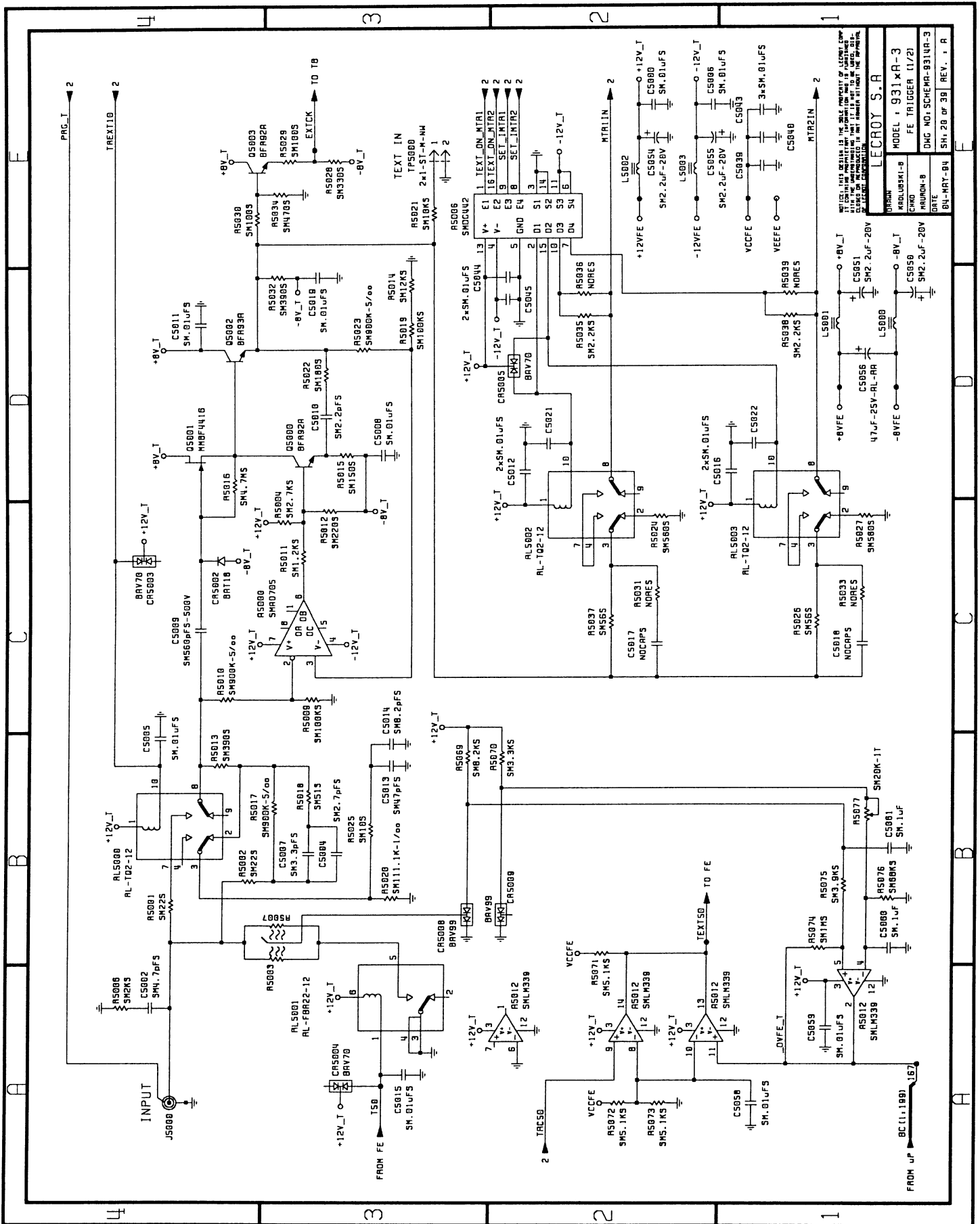

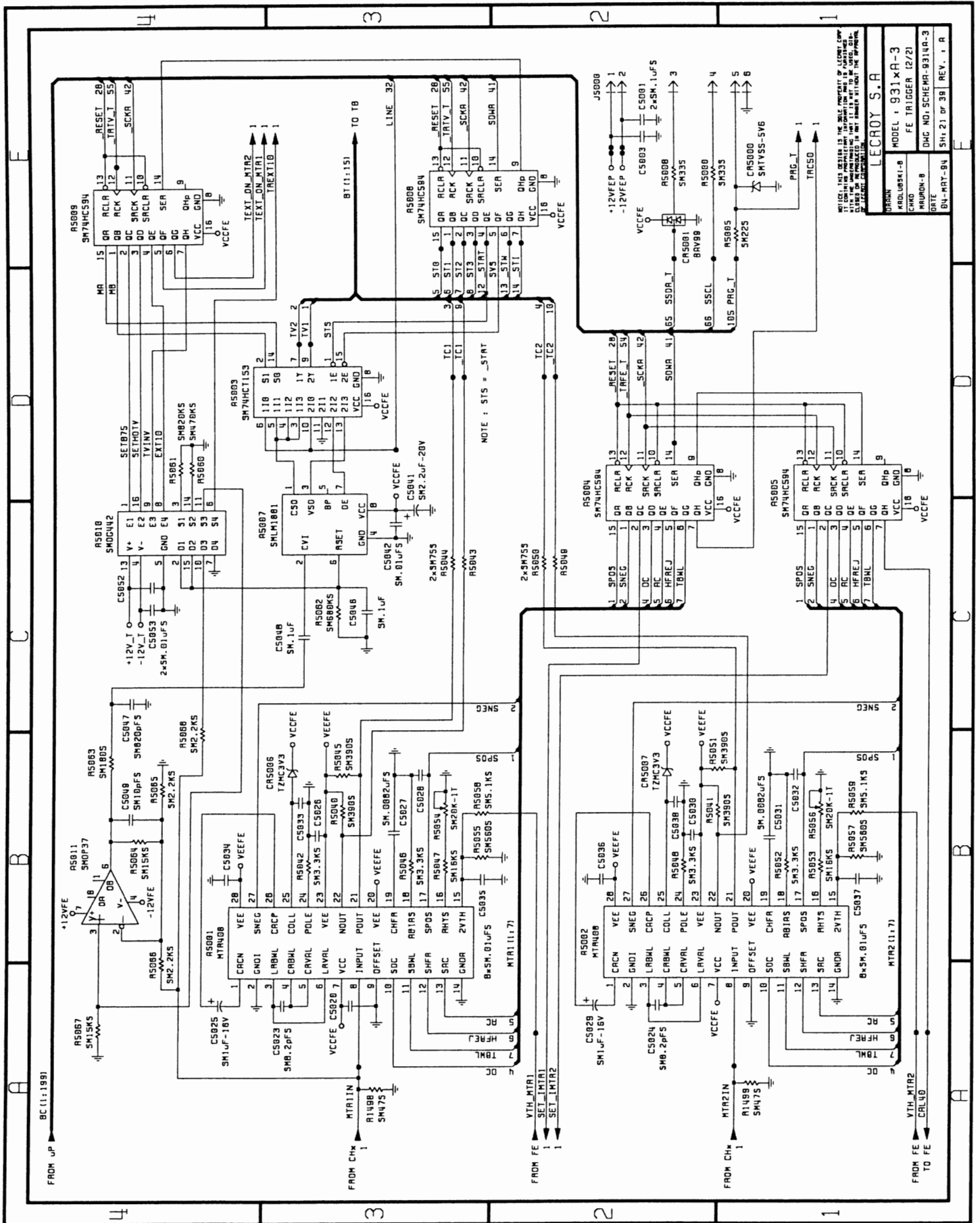

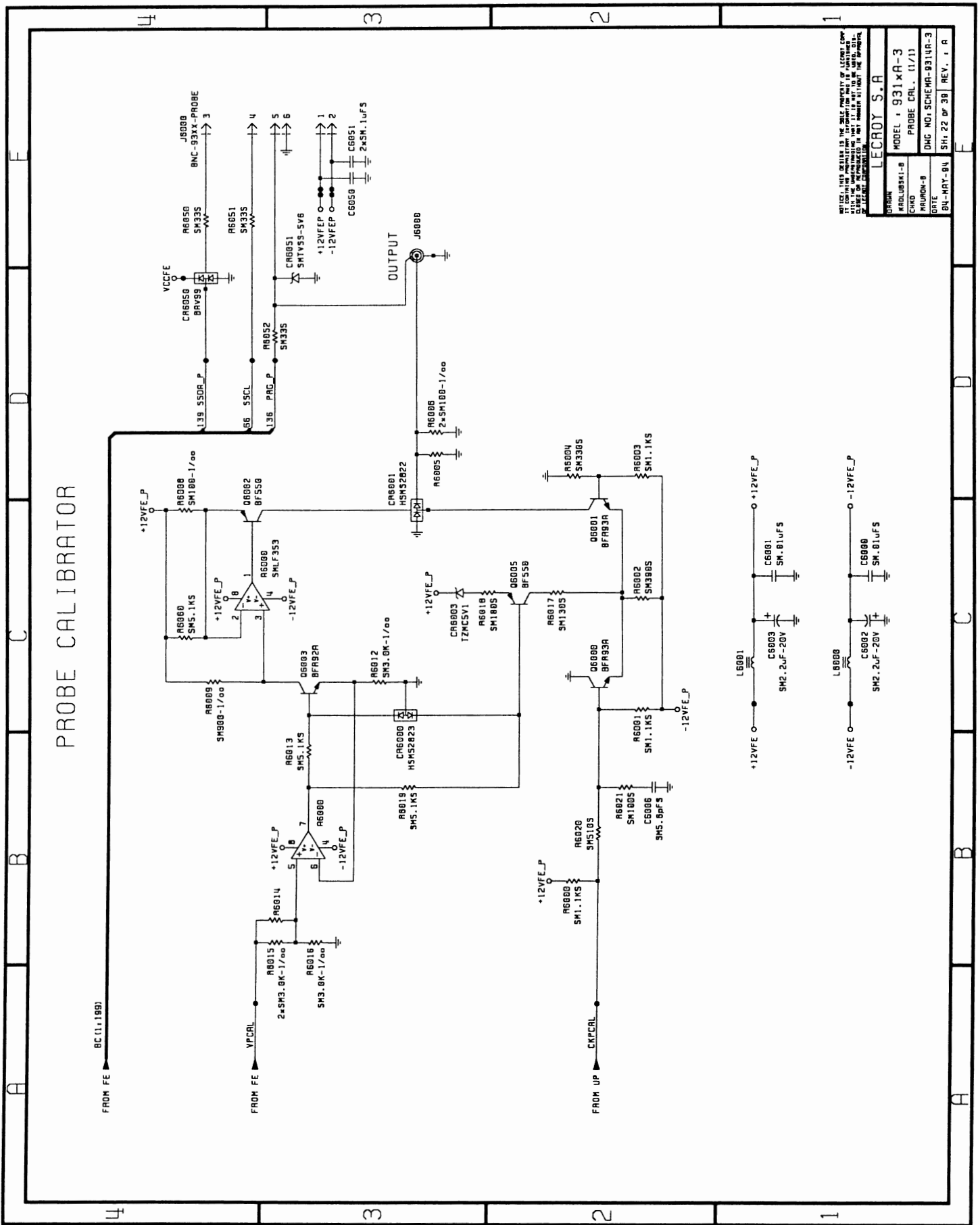

NOTICE: THIS DRAWING IS THE SOLE PROPERTY OF LECROY CORPORATION. IT CONTAINS PROPRIETARY INFORMATION AND IS TO BE KEPT STRICTLY CONFIDENTIAL. IT IS TO BE USED ONLY FOR THE PURPOSES SPECIFIED HEREIN. IT IS TO BE DESTROYED WHEN NO LONGER REQUIRED.

FORM	
MODEL	931xA-3
PROBE CAL.	11/11
DATE	04-MAY-84
REV.	1

PROBE CALIBRATOR

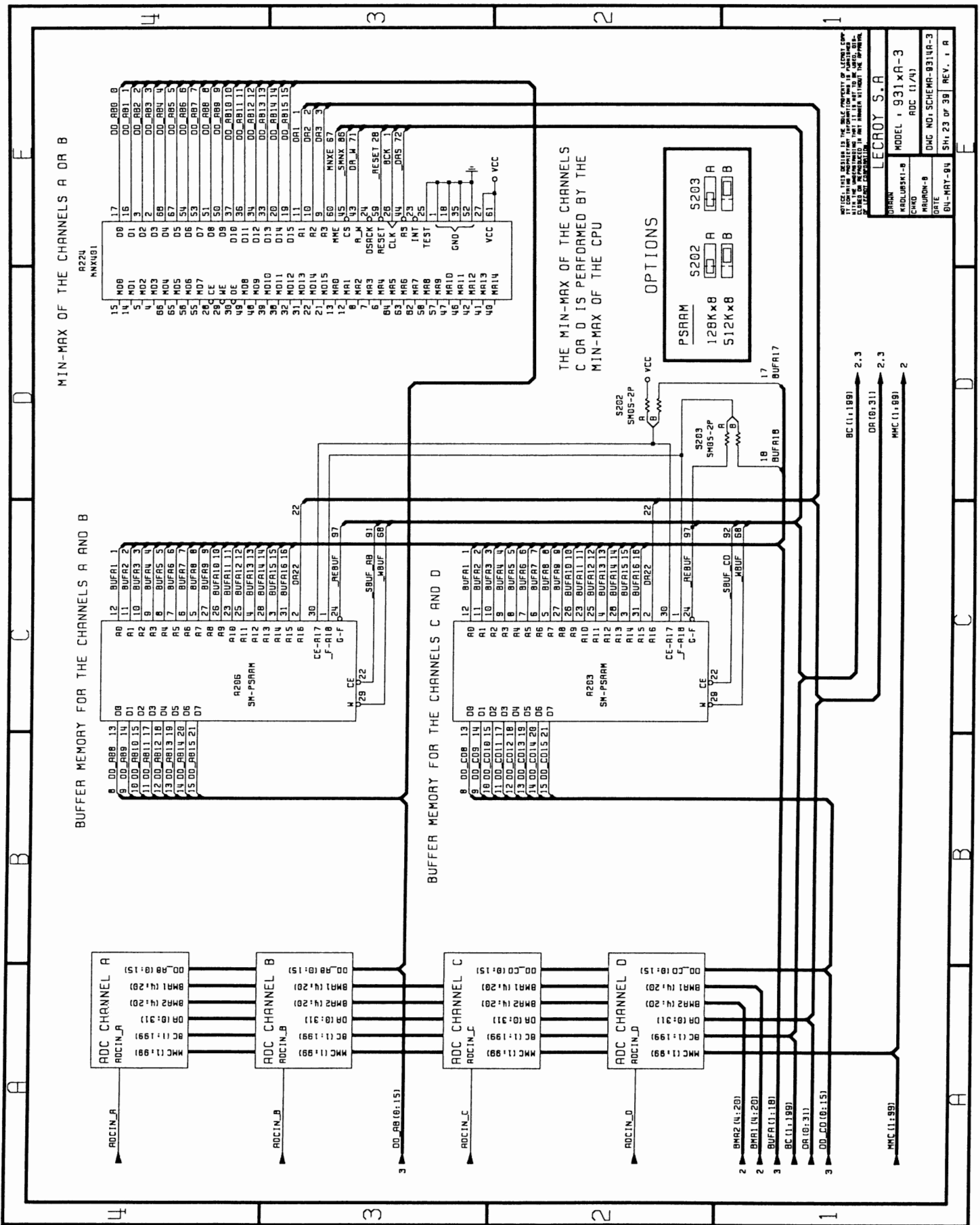

Section 8 Schematics, Layouts, Parts list

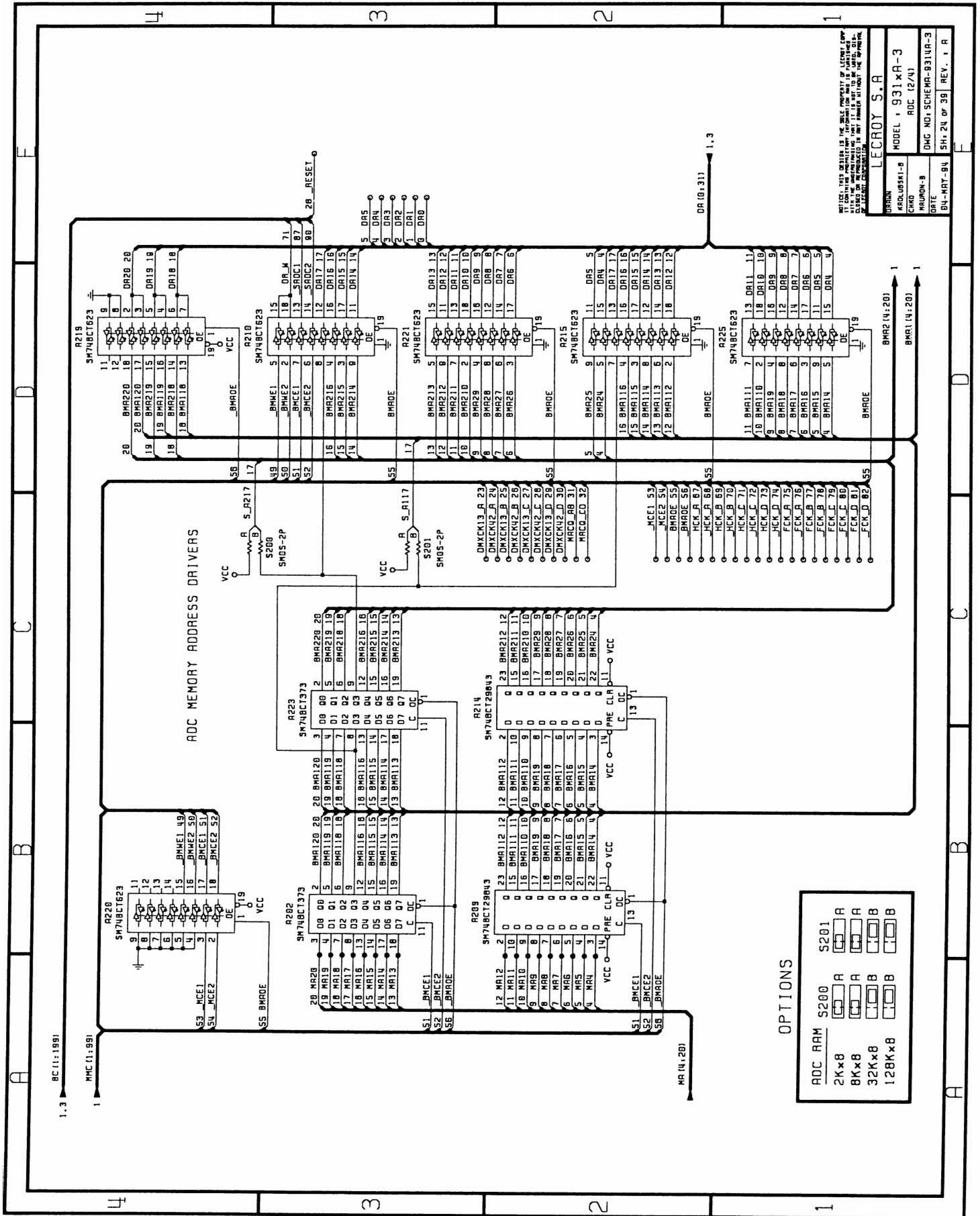

ADC MEMORY ADDRESS DRIVERS

OPTIONS

ADC RAM	S200	<input type="checkbox"/>	A
	S201	<input type="checkbox"/>	A
		<input type="checkbox"/>	B
		<input type="checkbox"/>	B

LECROY S.A.
 MODEL : 931xA-3
 ADC (2/4)
 MAJON-B
 DATE
 04-MAY-94
 SH: 24 of 36
 REV. : A

NOTICE: THIS DRAWING IS THE SINGLE COMPONENT OF LAYOUT EMPLOYING THE CONCEPT OF PARTIAL DRAWING. IT IS NOT TO BE USED SEPARATELY. ANY CHANGES OR MODIFICATIONS TO THIS DRAWING WILL AFFECT THE ENTIRE DRAWING.

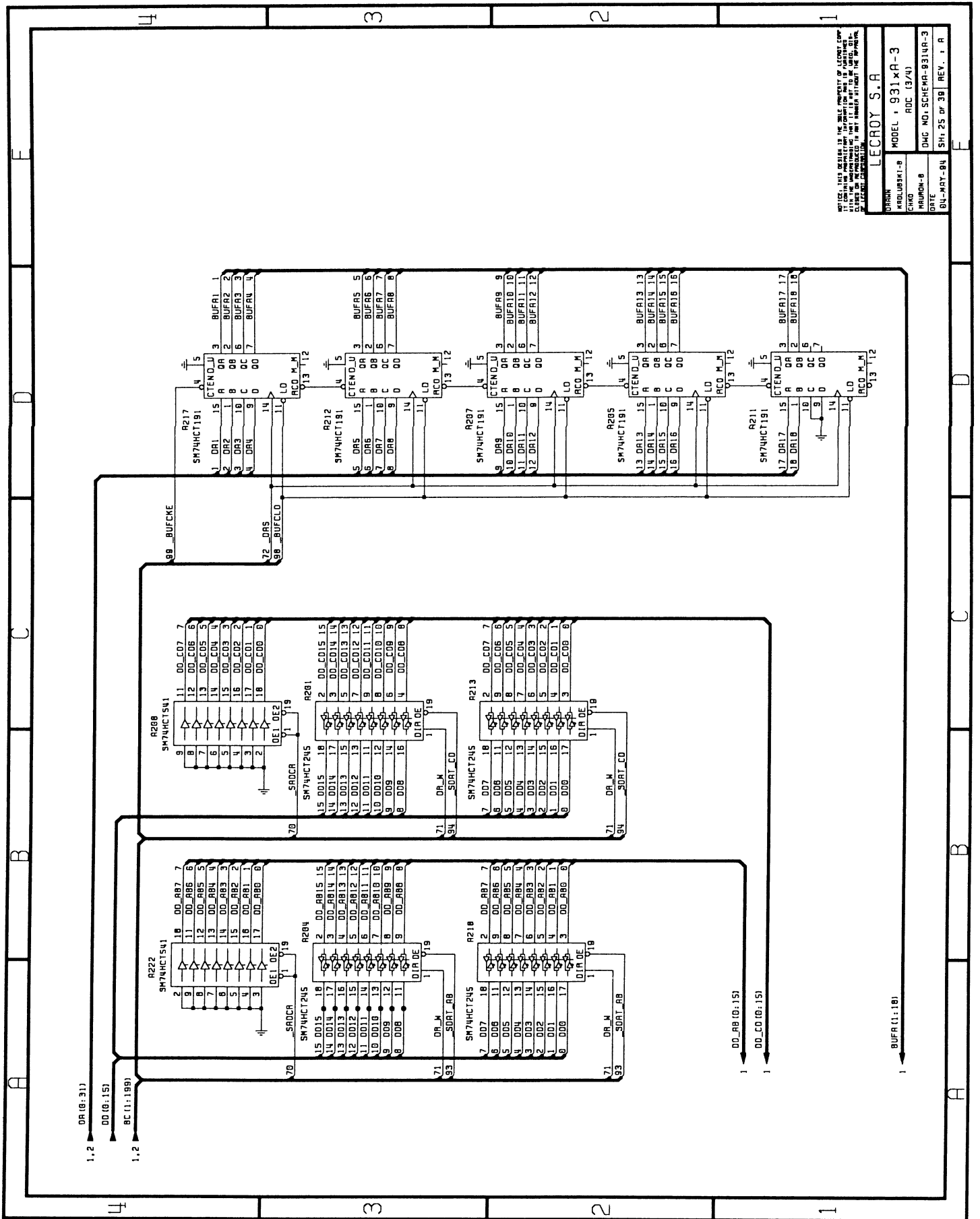

Section 8 Schematics, Layouts, Parts list

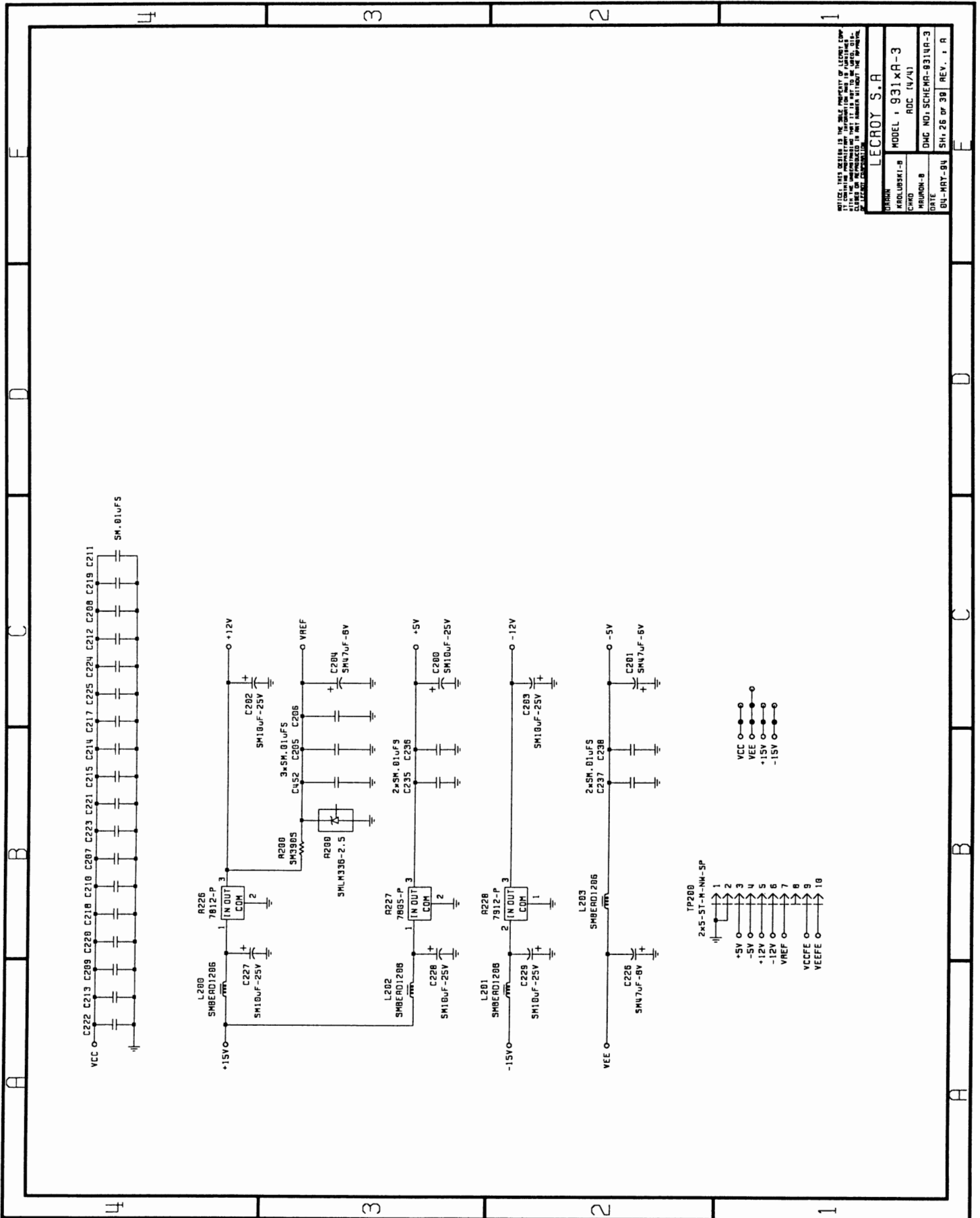

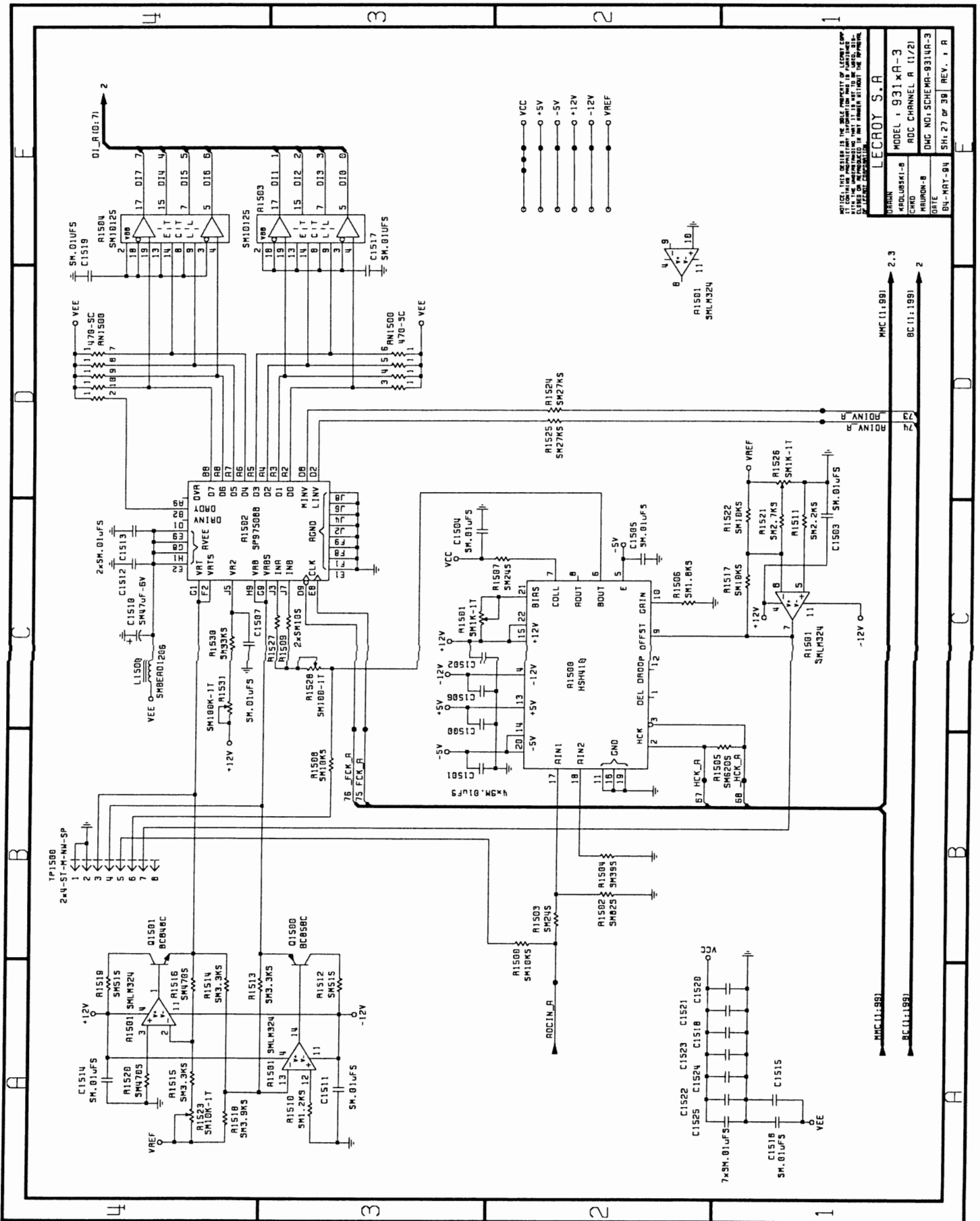

Section 8 Schematics, Layouts, Parts list

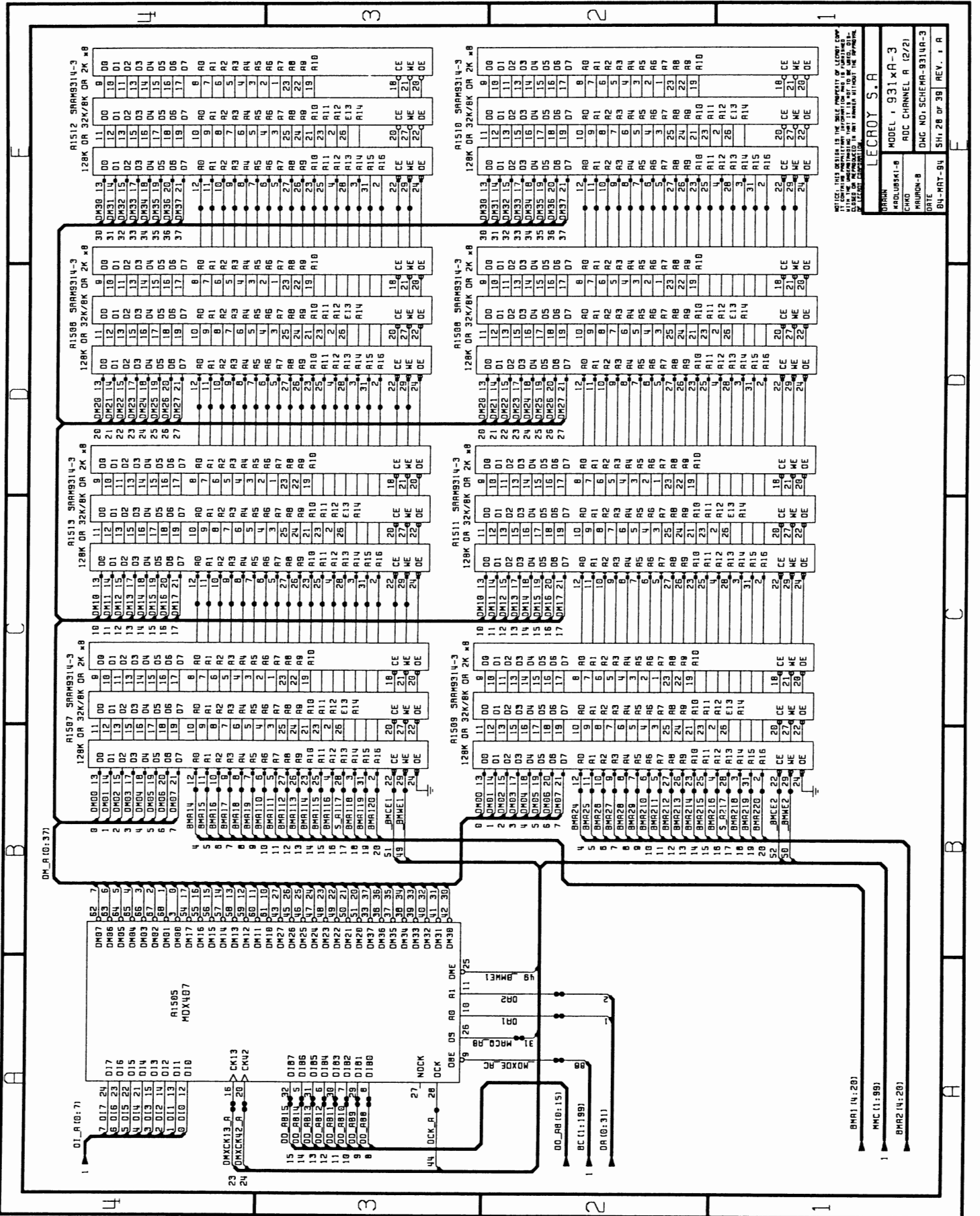

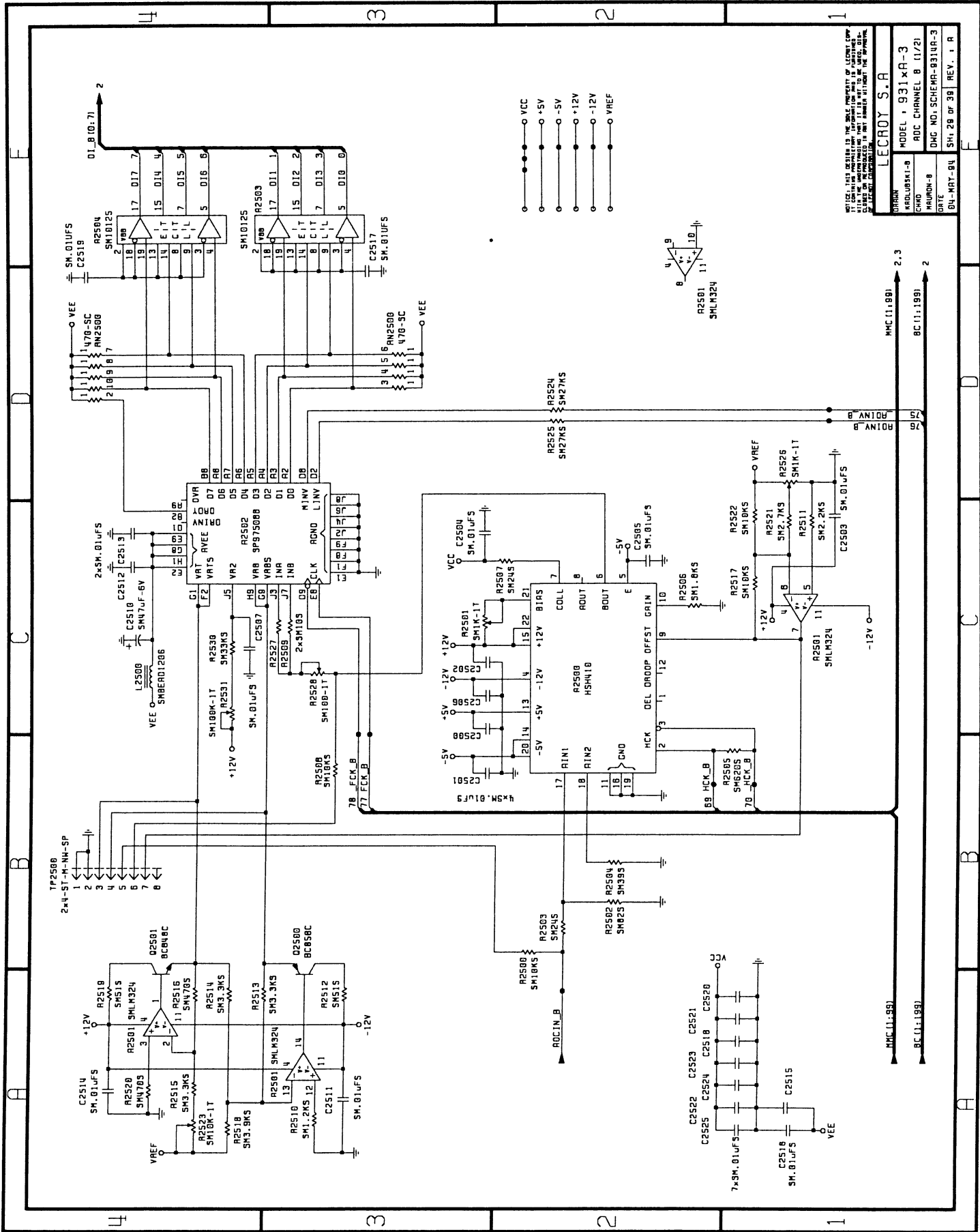

WHILE THIS DESIGN IS THE SOLE PROPERTY OF LEADON S.A. IT IS MADE AVAILABLE TO YOU AS A COURTESY. IT IS NOT TO BE REPRODUCED OR TRANSMITTED IN ANY FORM OR BY ANY MEANS WITHOUT THE PERMISSION OF LEADON S.A.

DRAWN: LEADON S.A.
 MODEL: 931XA-3
 ADC CHANNEL B (1/2)
 PART NO. 931XA-3
 DATE: SH-29 OF 38 REV. 1 R
 BU-MAT-94

Section 8 Schematics, Layouts, Parts list

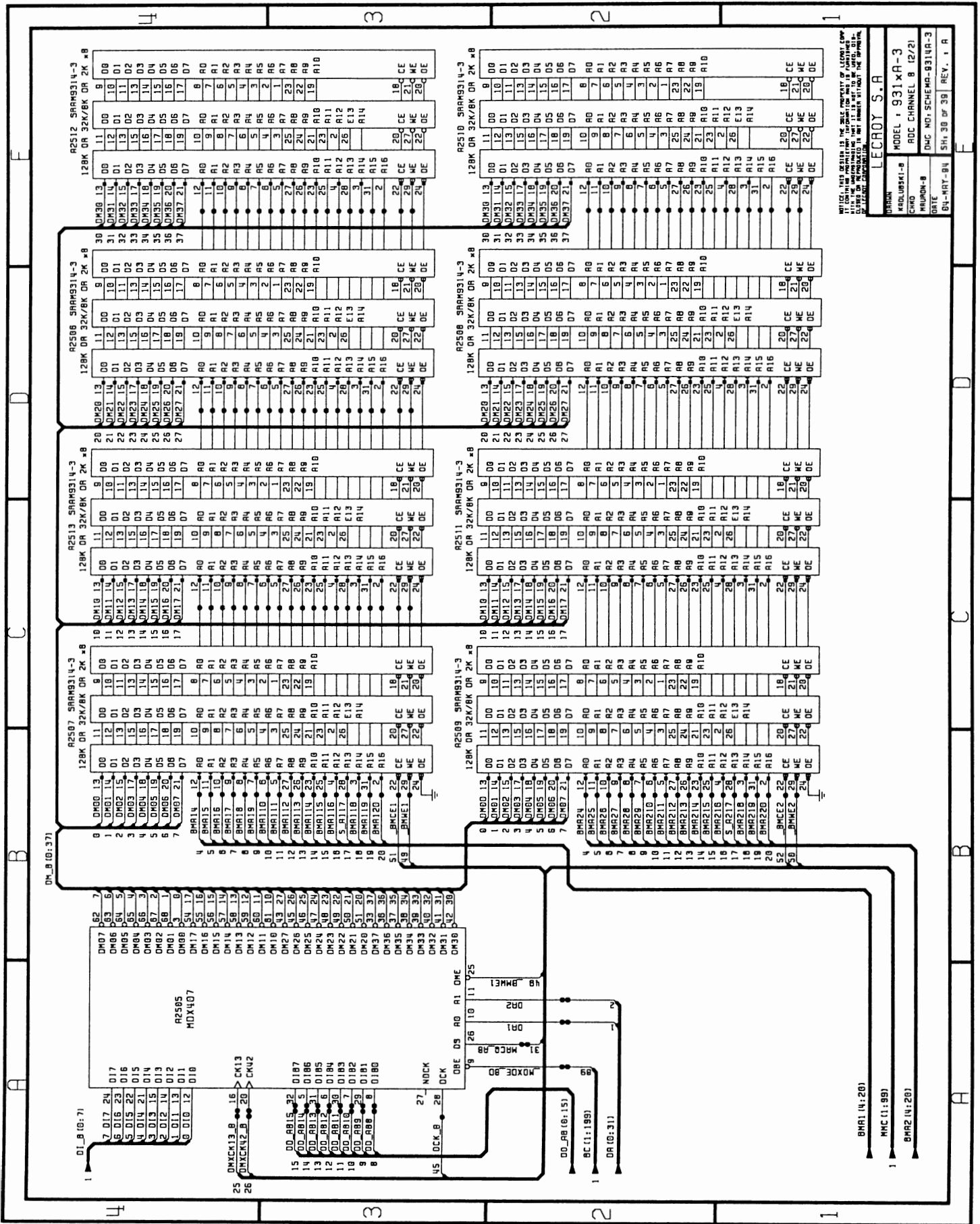

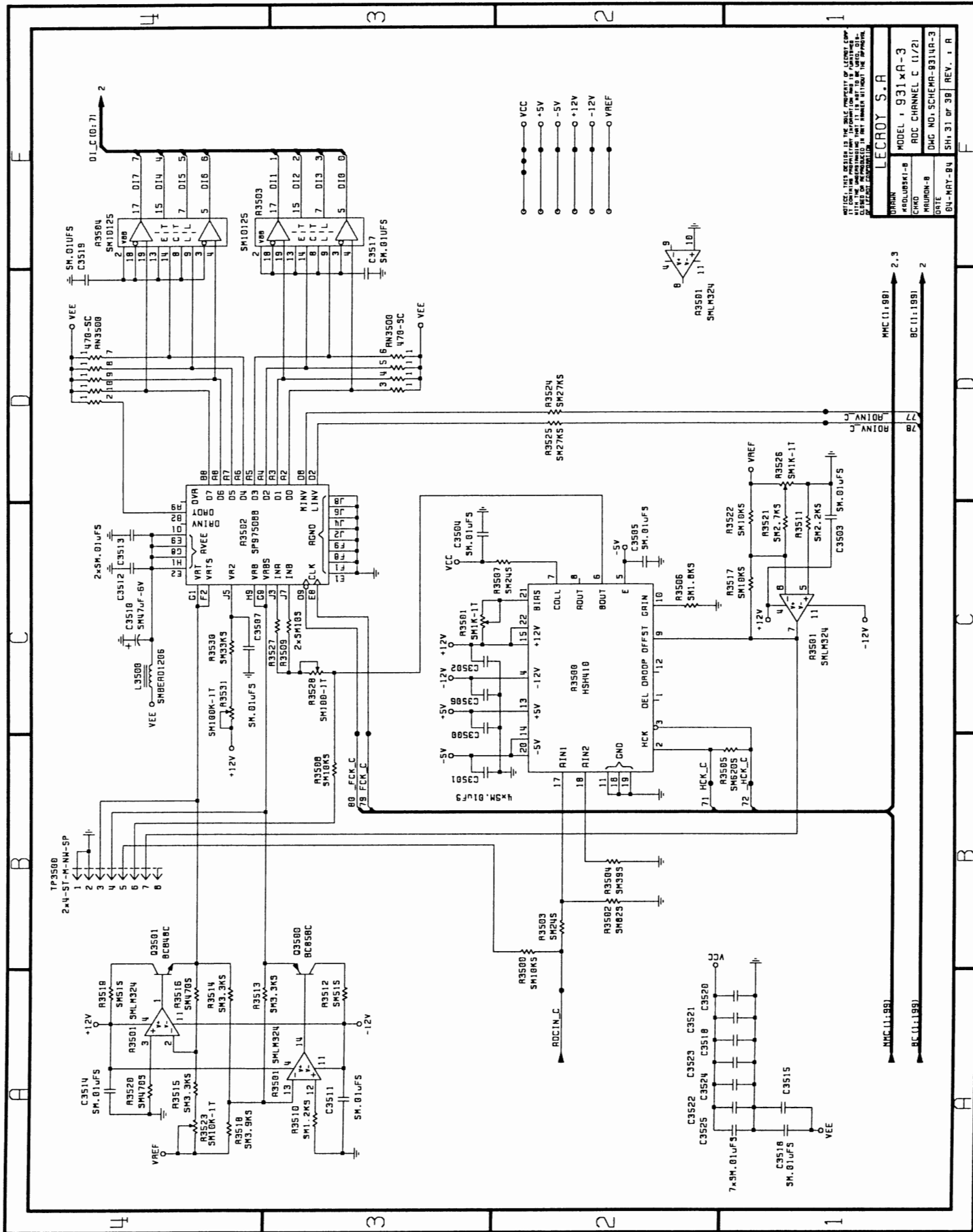

Section 8 Schematics, Layouts, Parts list

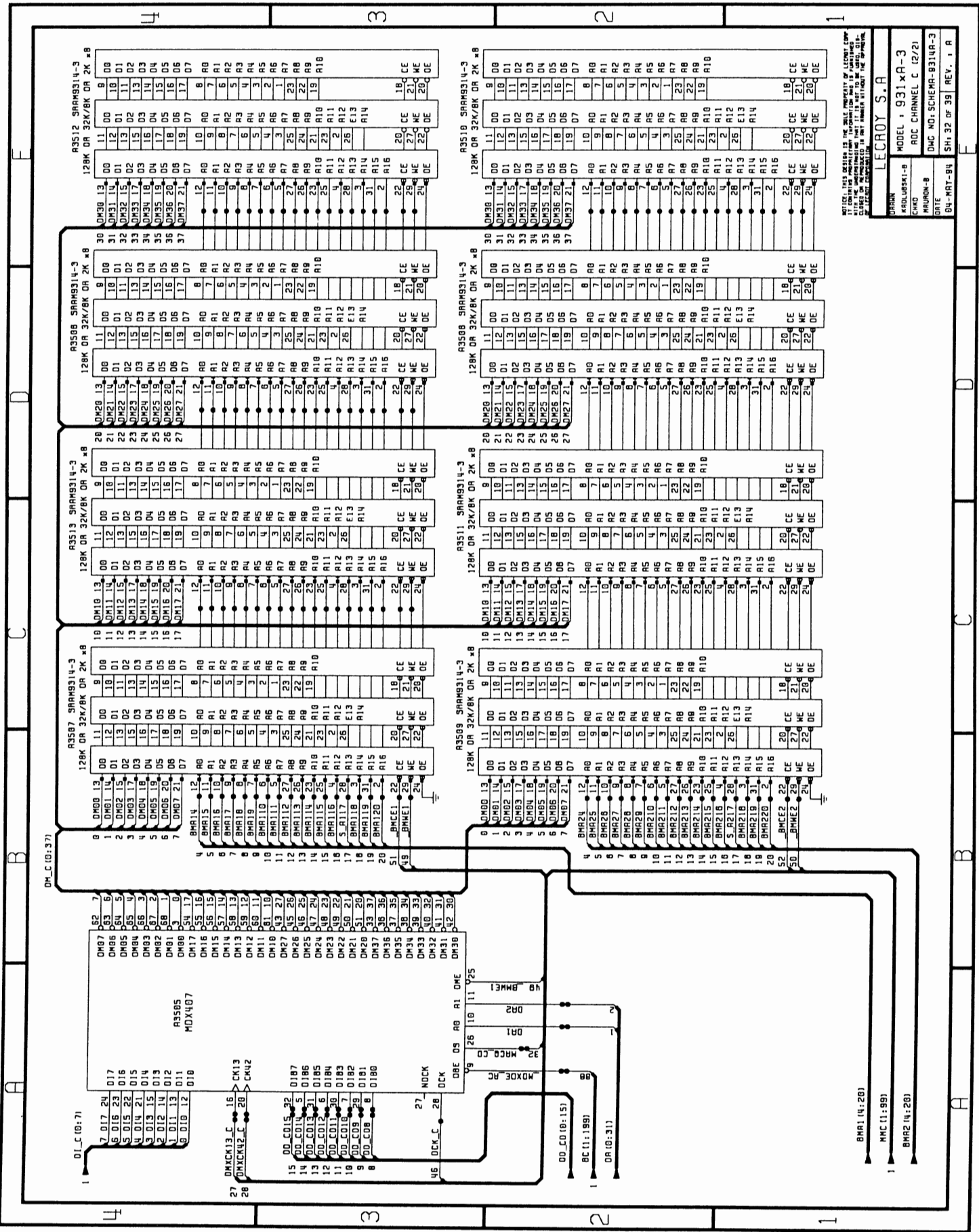

NOTICE: THIS DESIGN IS THE SOLE PROPERTY OF LECOLOGY. ALL RIGHTS ARE RESERVED. NO PART IS TO BE REPRODUCED, EITHER WHOLLY OR IN PART, WITHOUT THE WRITTEN CONSENT OF LECOLOGY.

MODEL : 931XA-3
 RDC CHANNEL C (2/21)
 DATE
 SH-32 of 39 REV. 1 A

LECOLOGY S.A.
 4500051-8
 4500051-9
 4500051-9

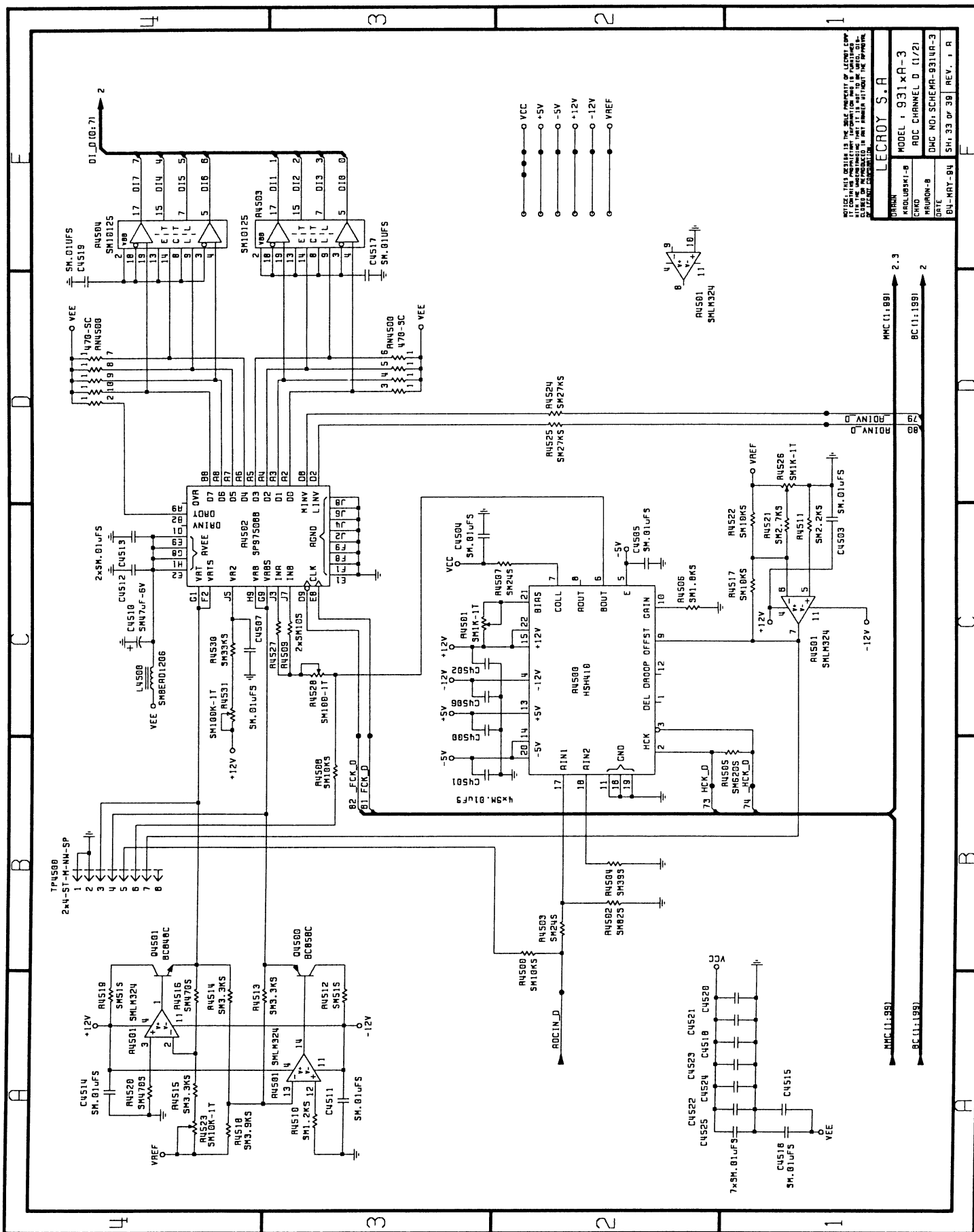

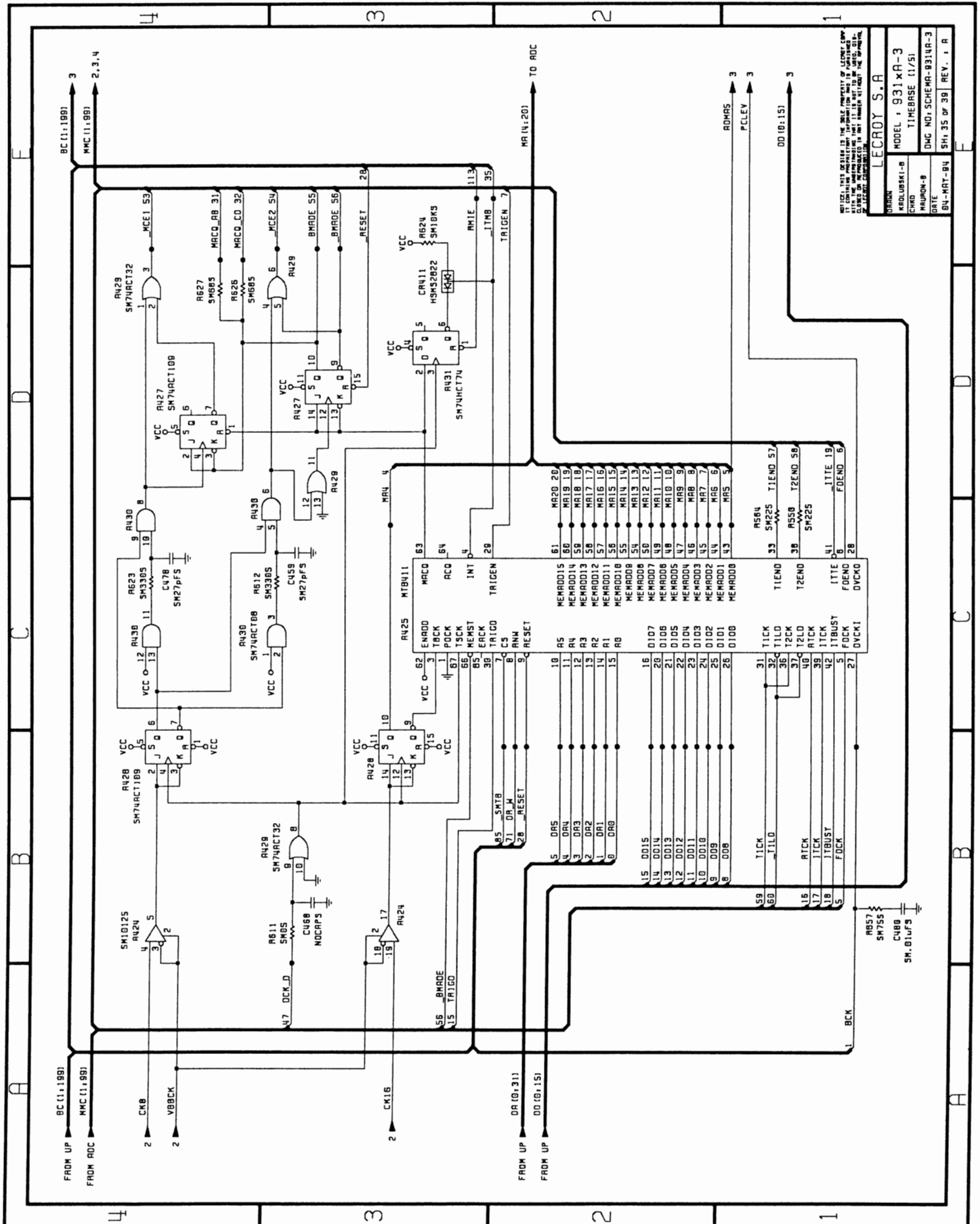

NOTE: THIS DRAWING IS THE ONLY AUTHORITY OF LECROY S.A. FOR THE CONTAINING PROPRIETARY INFORMATION. THIS INFORMATION IS UNCLASSIFIED BY THE NATIONAL ARCHIVES AND IS AVAILABLE TO THE PUBLIC. ALL RIGHTS RESERVED.

LECROY S.A.

DESIGN	MODEL : 931 x A-3
REVISION	TIMEBASE (1/5)
DATE	DWG NO: SCHEMA-931A-3
	BY: JY-84 REV. : R

Section 8 Schematics, Layouts, Parts list

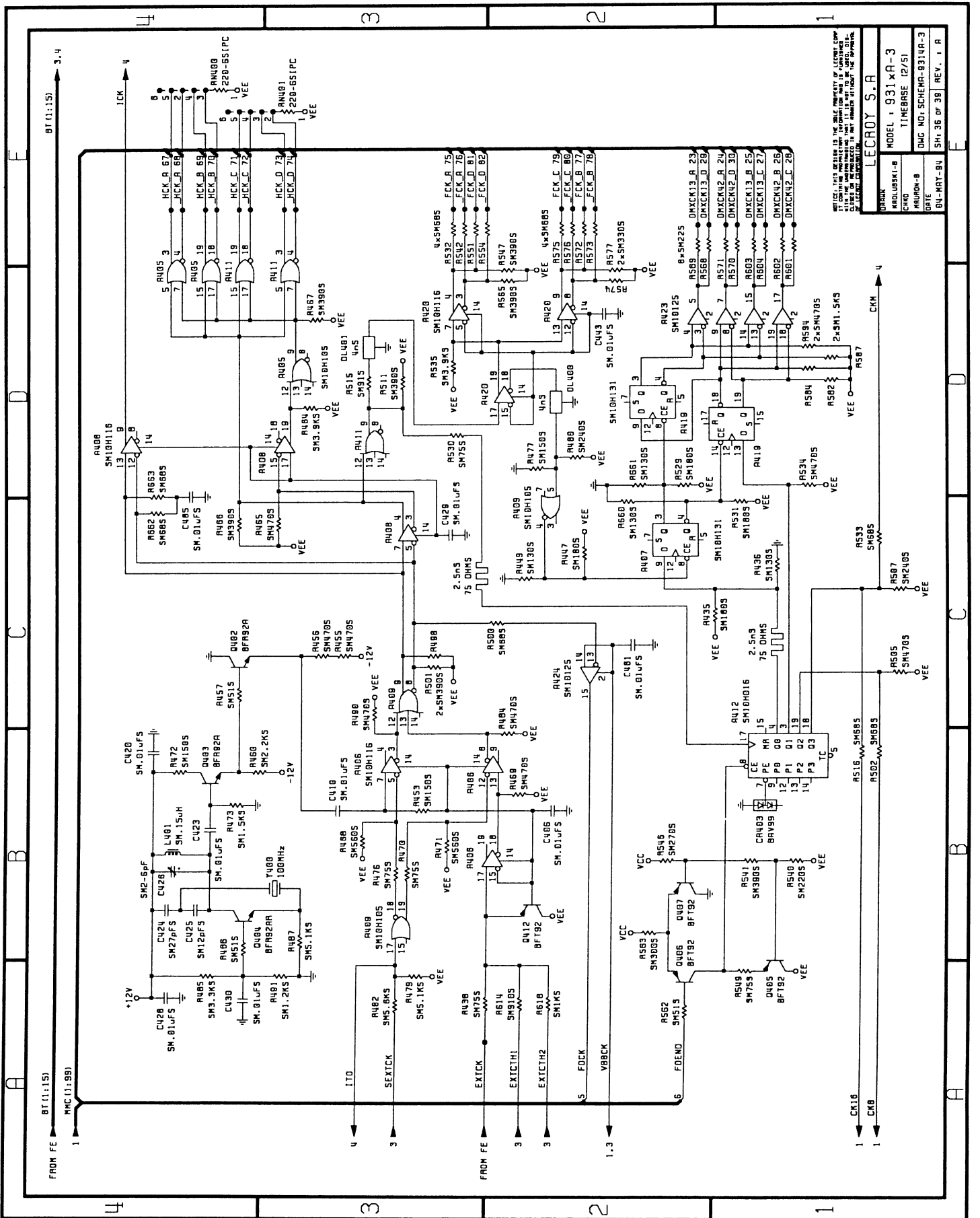

LECROY S.A.	
MODEL	931XA-3
TIMEBASE	12/51
DWG NO.	SCHEM-931A-3
REV.	1 A
DATE	81-MAY-84
DRWING	ADRIANO
PROJ. ENGR.	ADRIANO
CHKD	ADRIANO
DATE	81-MAY-84

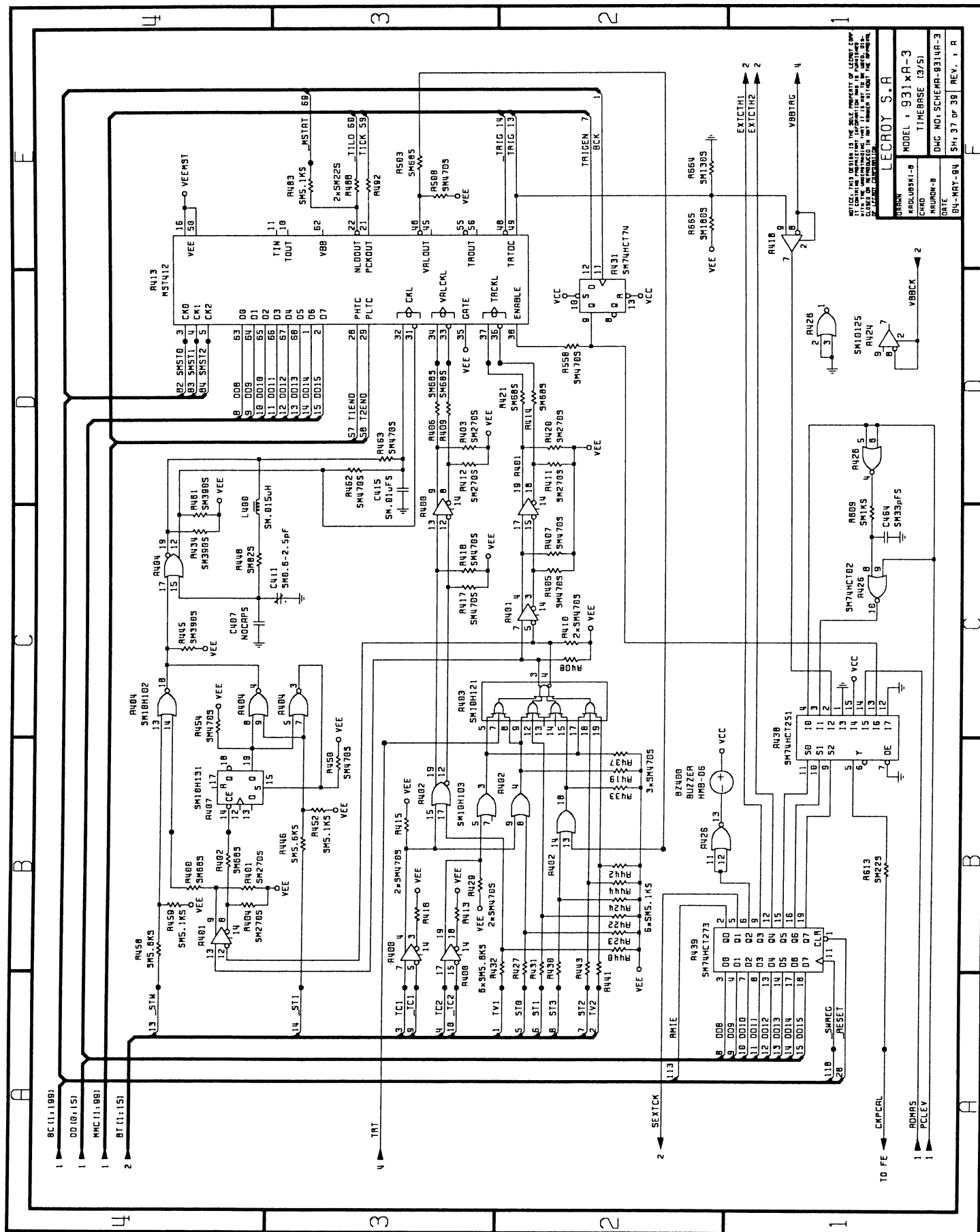

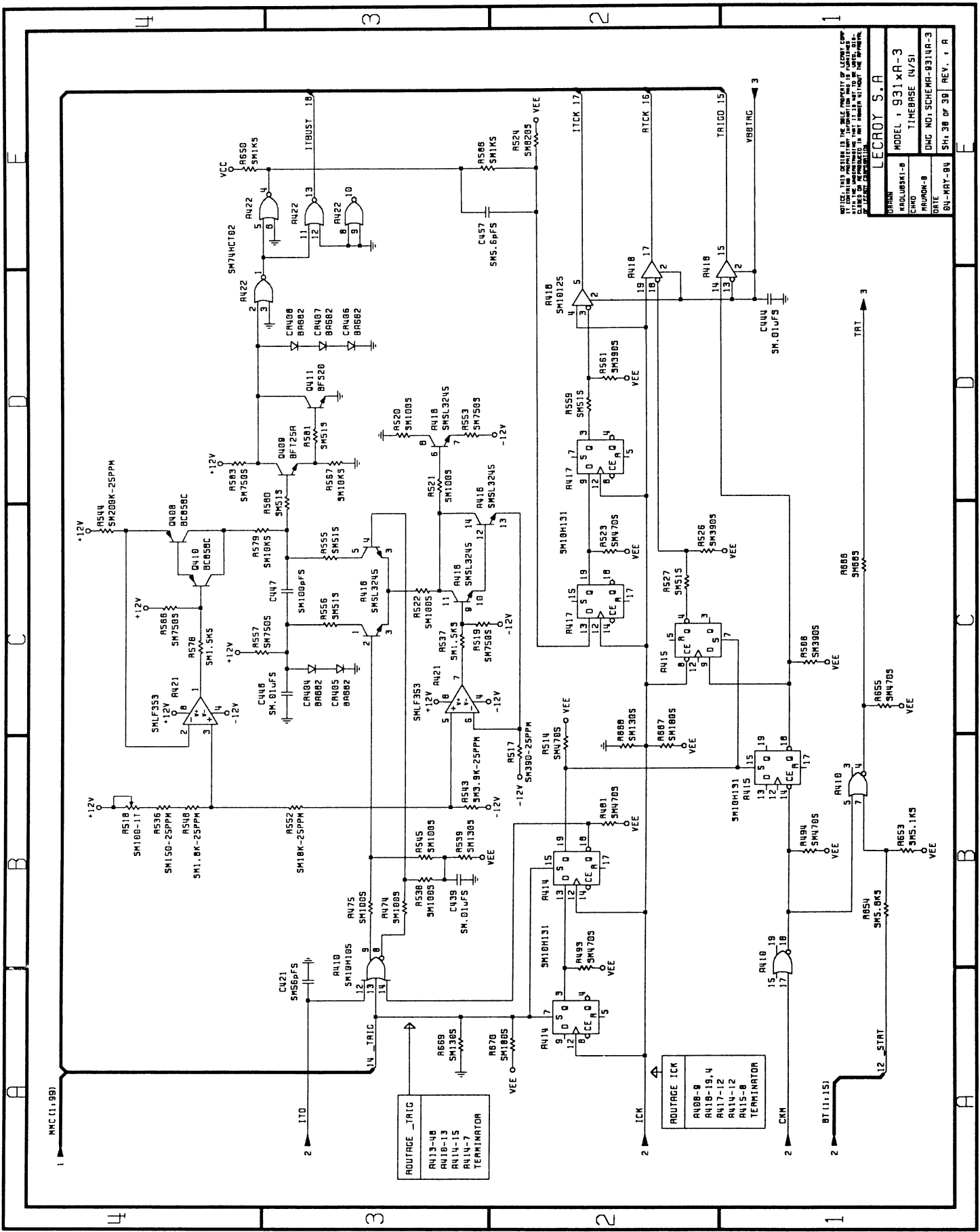

NOTICE: THIS SCHEMATIC IS THE PROPERTY OF LECROY S.A. IT CONTAINS PROPRIETARY INFORMATION THAT IS UNLAWFUL TO BE REPRODUCED OR TRANSMITTED IN ANY FORM OR BY ANY MEANS, ELECTRONIC OR MECHANICAL, INCLUDING PHOTOCOPYING, RECORDING, OR BY ANY INFORMATION STORAGE AND RETRIEVAL SYSTEM.

LECROY S.A.
 MODEL : 931xA-R3
 TIMEBASE (4/75)
 DMC NO: SCHEM-8314A-3
 DATE
 BU-KRY-84 SH. 38 OF 38 REV. . . A

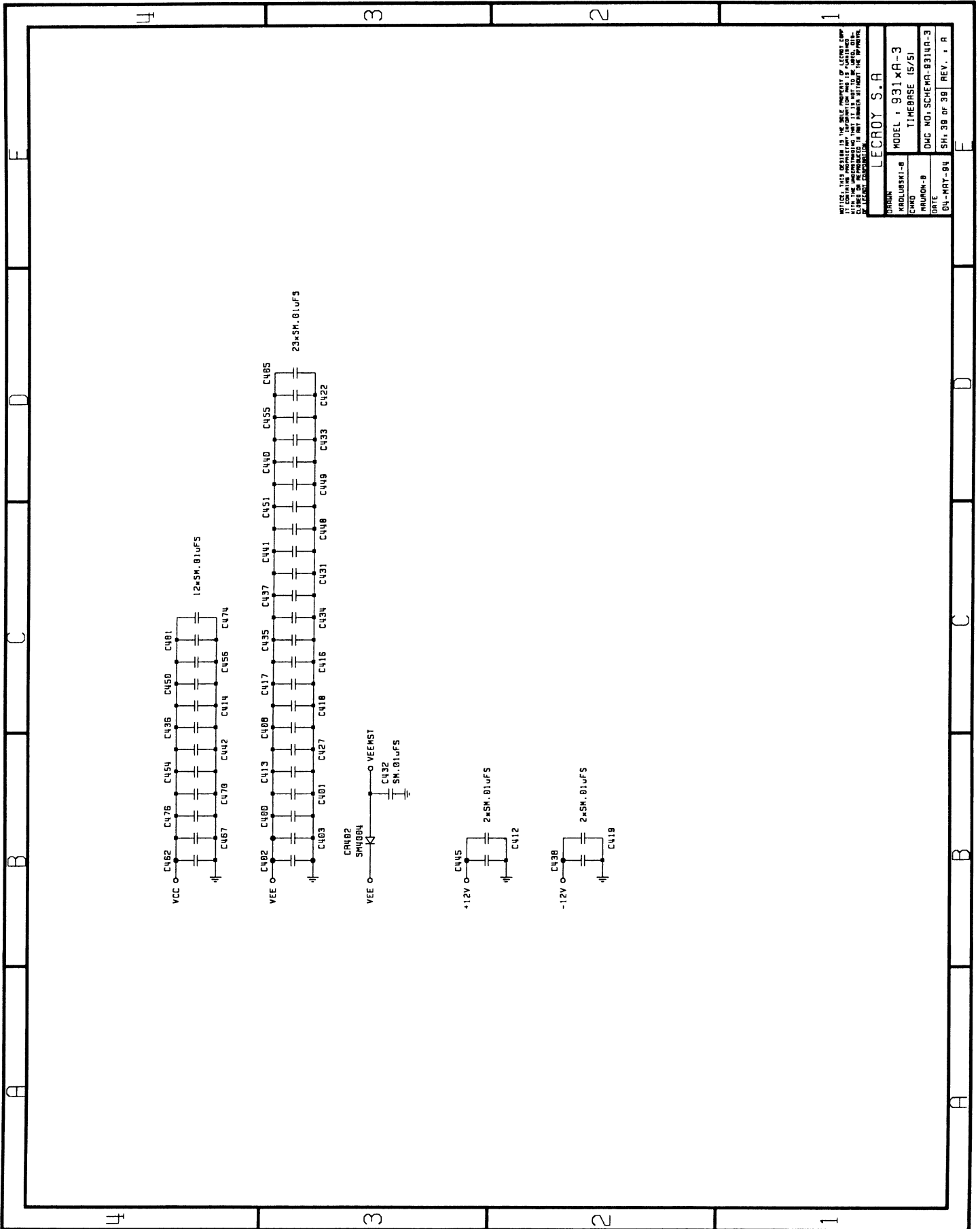

NOTICE: THIS DESIGN IS THE SOLE PROPERTY OF LECROY. LEMP
 ALL RIGHTS ARE RESERVED. THIS DESIGN IS NOT TO BE REPRODUCED,
 COPIED, OR TRANSMITTED IN ANY FORM OR BY ANY MEANS, ELECTRONIC,
 MECHANICAL, OR BY ANY INFORMATION STORAGE AND RETRIEVAL SYSTEM,
 WITHOUT THE WRITTEN PERMISSION OF LECROY.

UNION	LECROY S.A.
MODEL	931XA-3
TIMEBASE	15/51
DATE	04-MAY-81
REV.	1 A

9314A-3 Rev: B

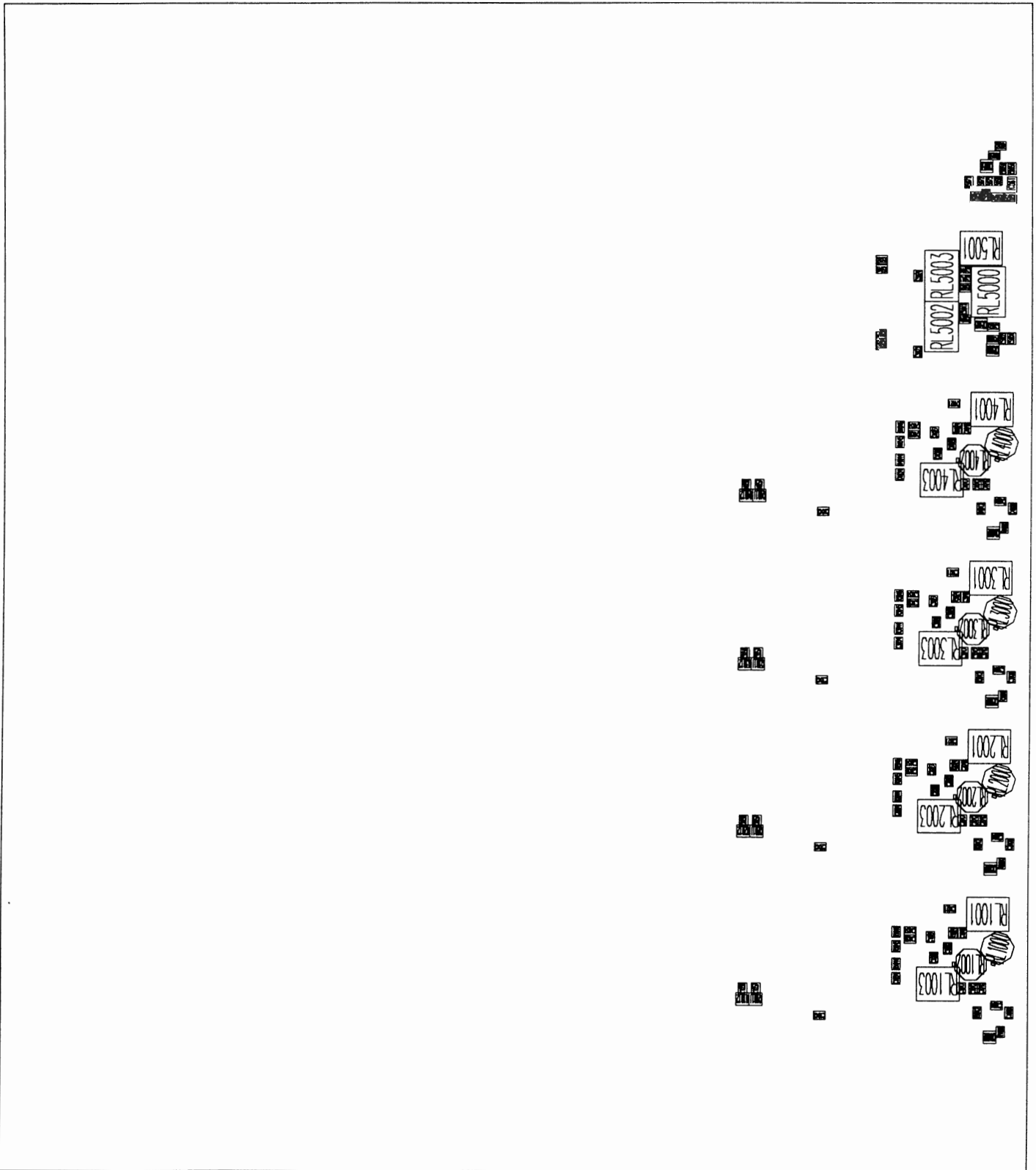

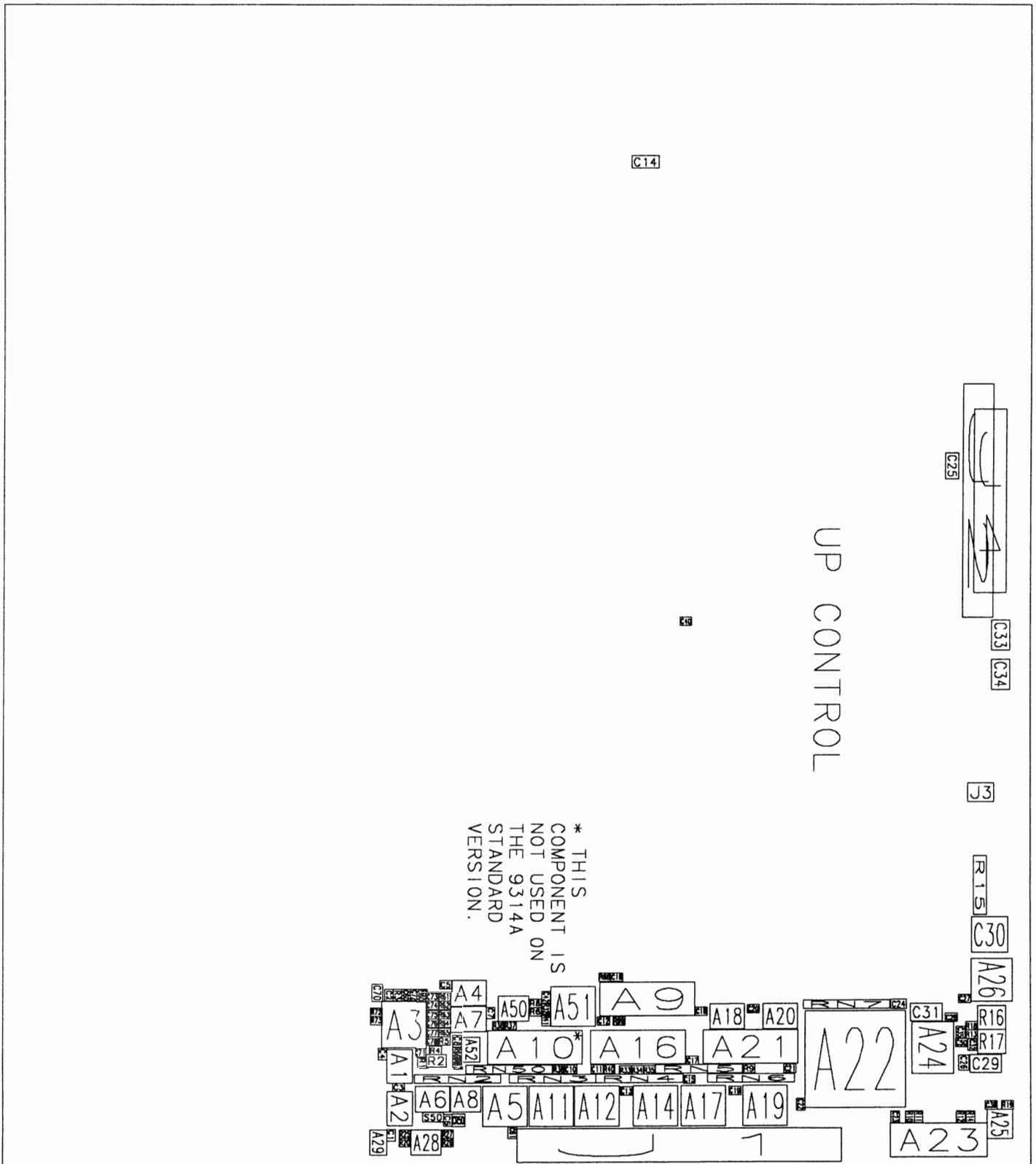

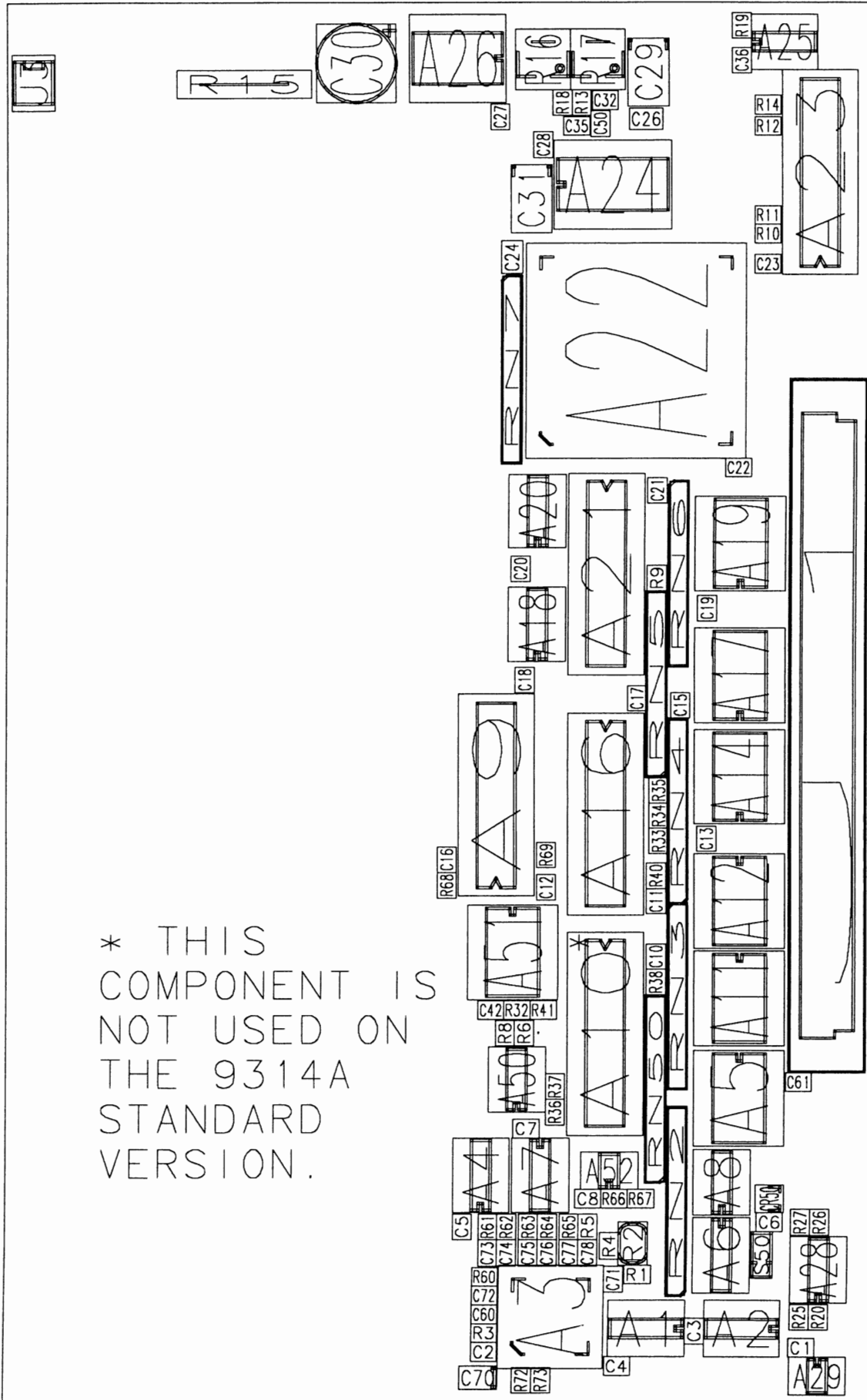

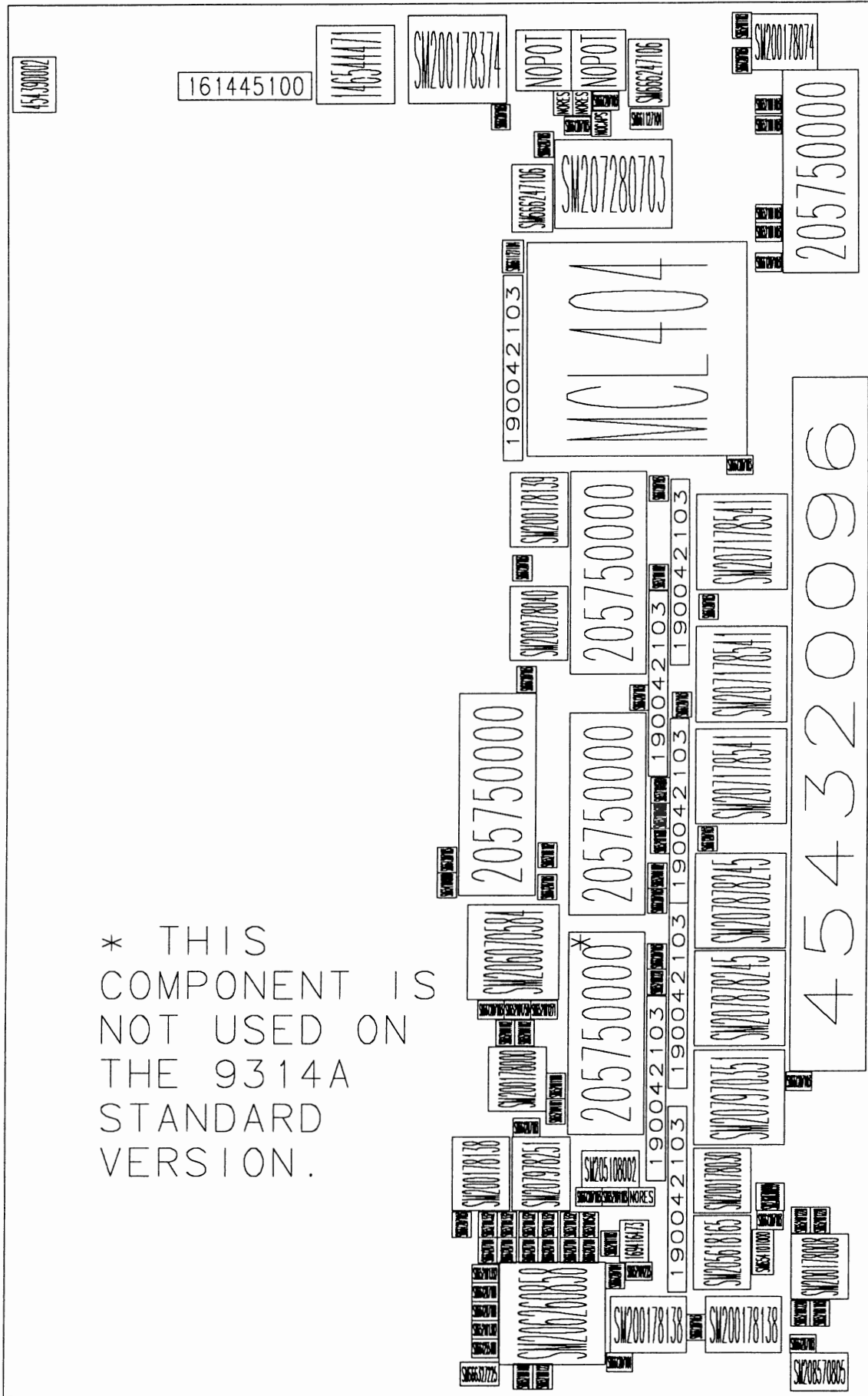

* THIS COMPONENT IS NOT USED ON THE 9314A STANDARD VERSION.

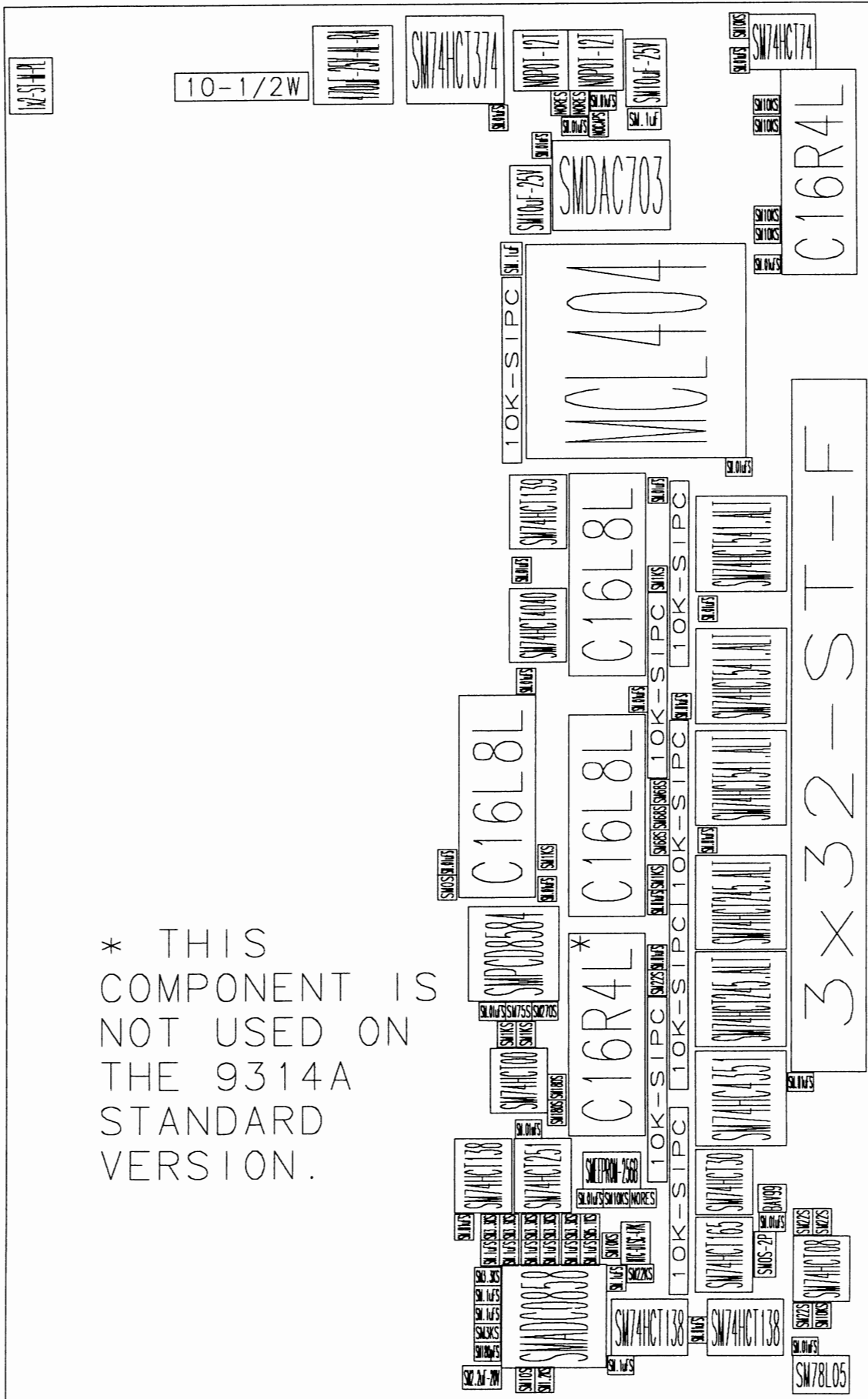

* THIS COMPONENT IS NOT USED ON THE 9314A STANDARD VERSION.

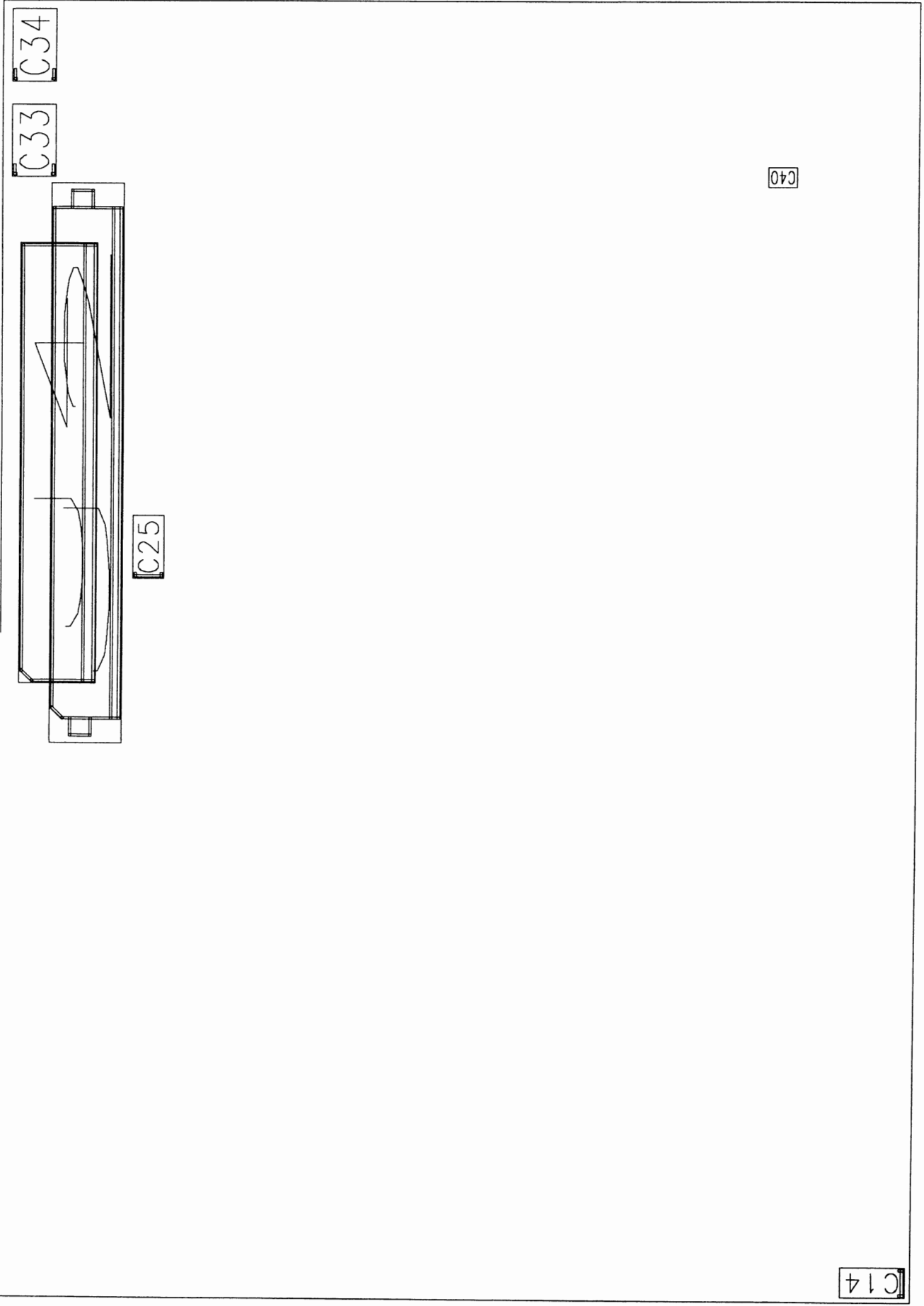

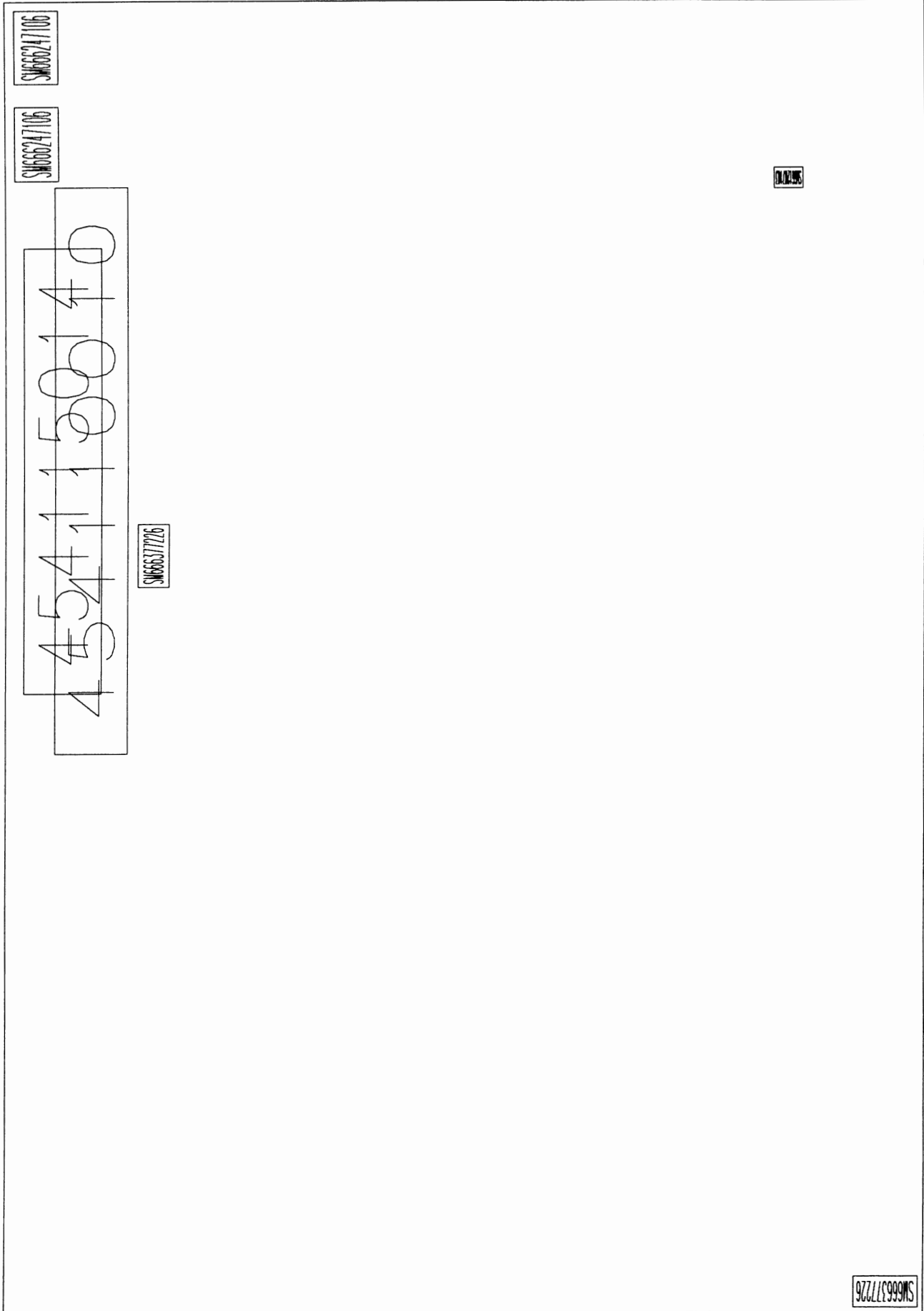

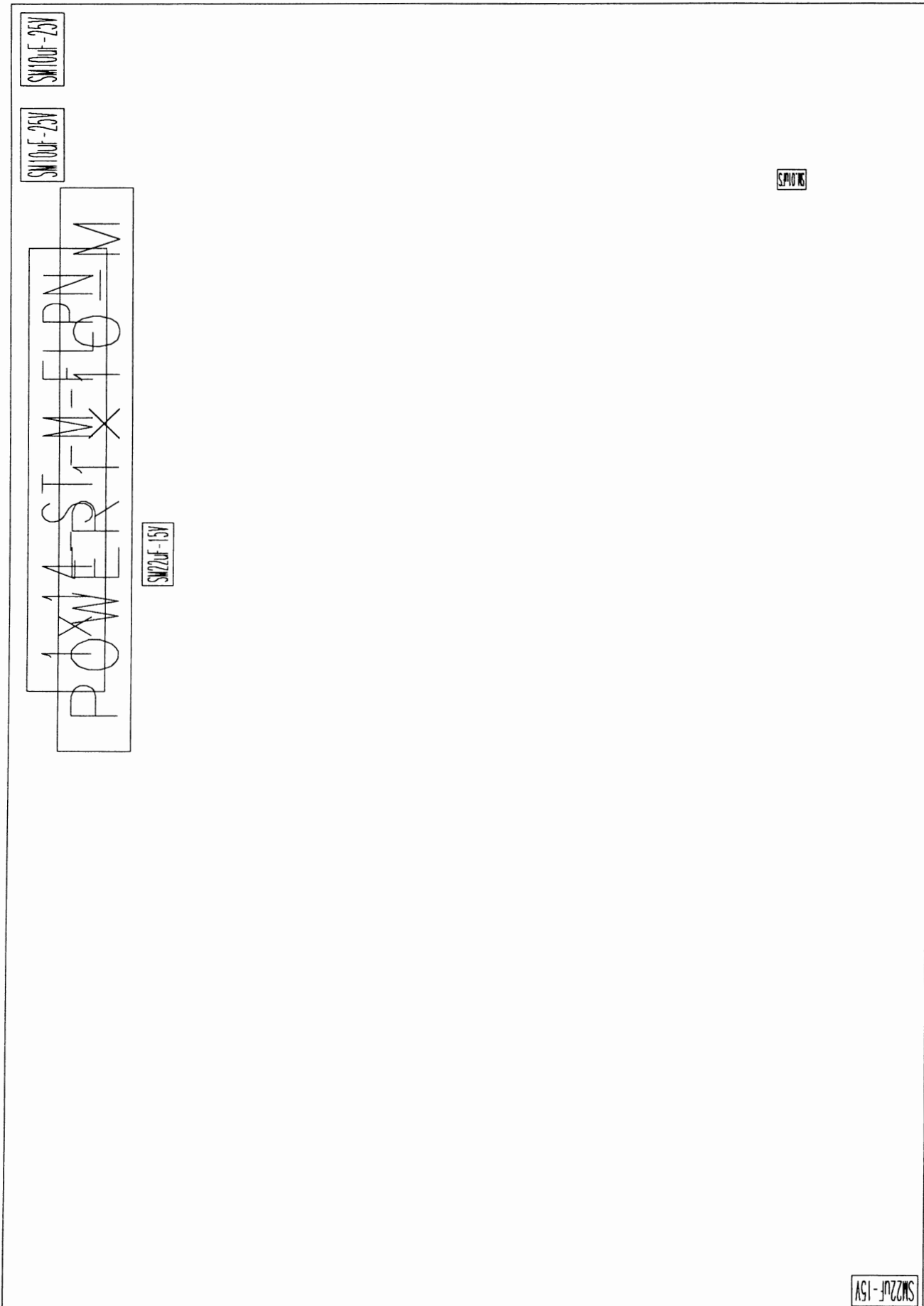

9314A-3 Rev:B

FE CONTROL

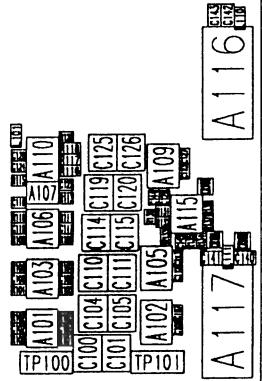
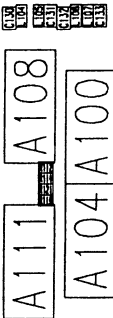

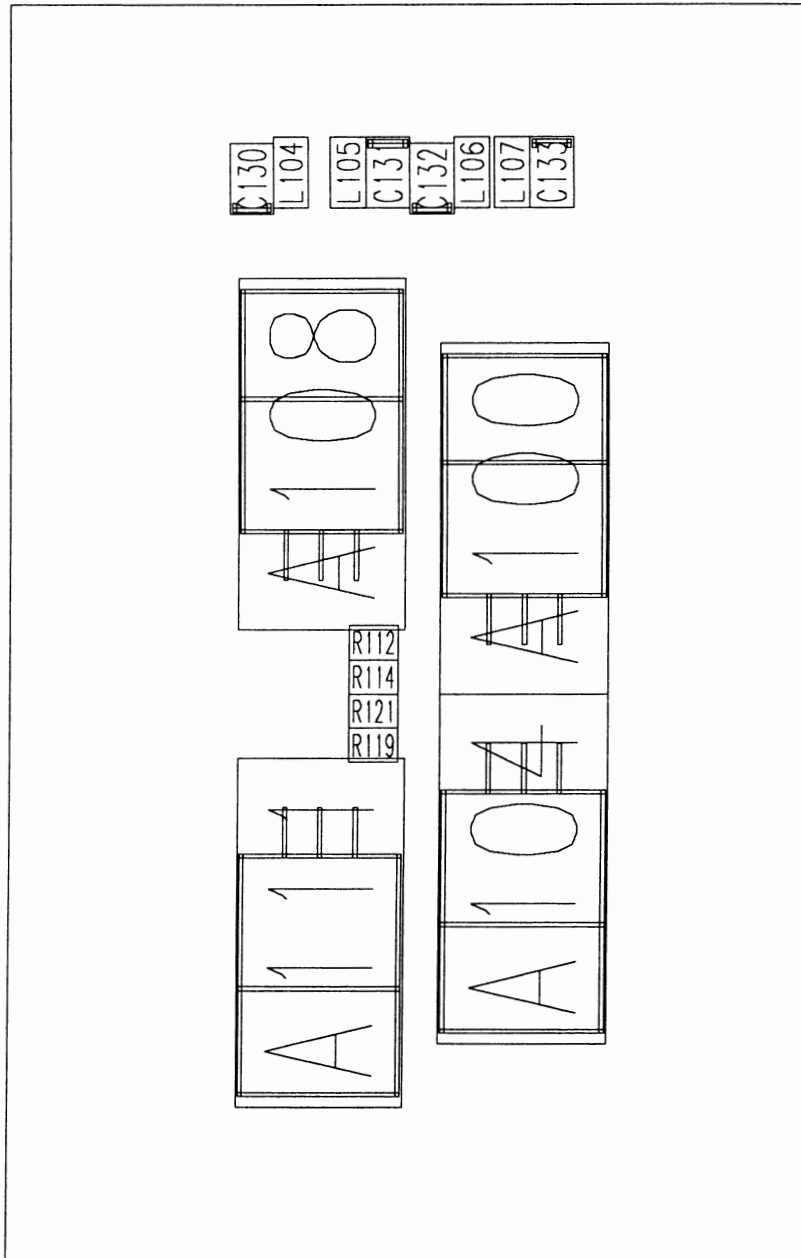

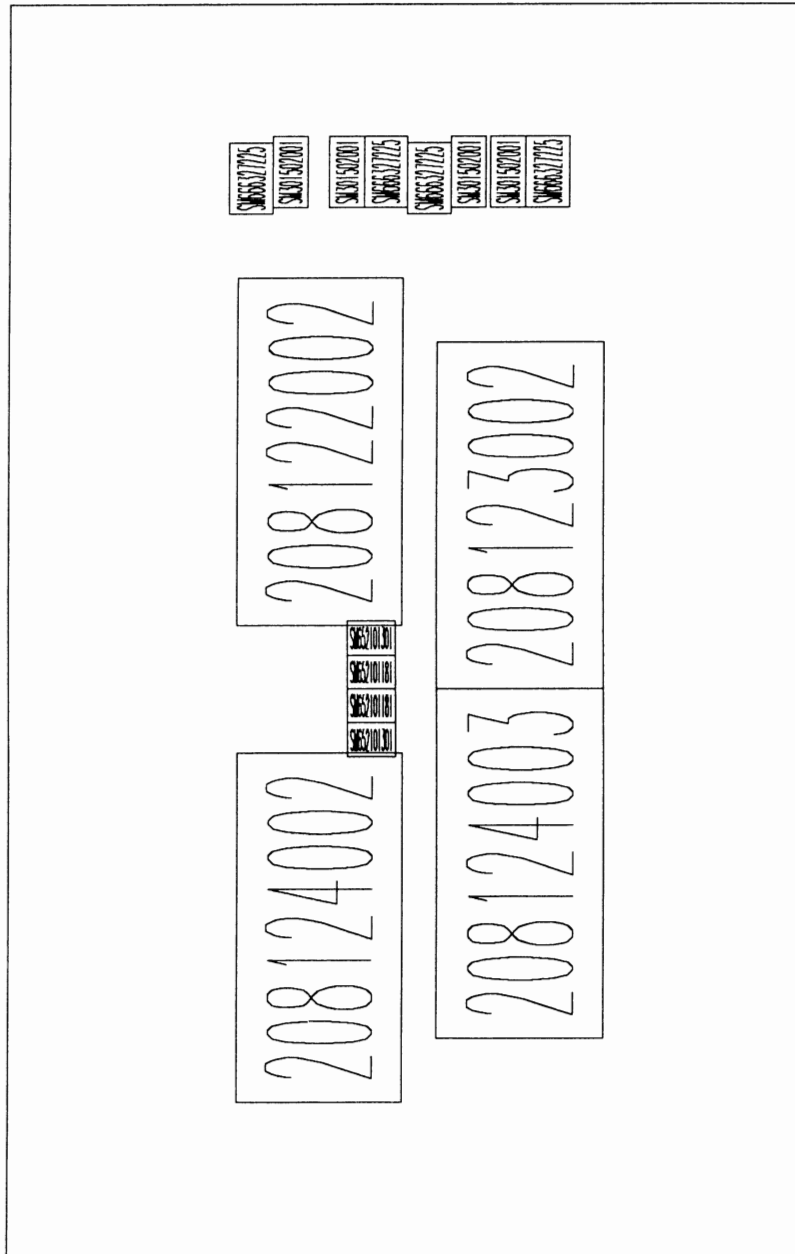

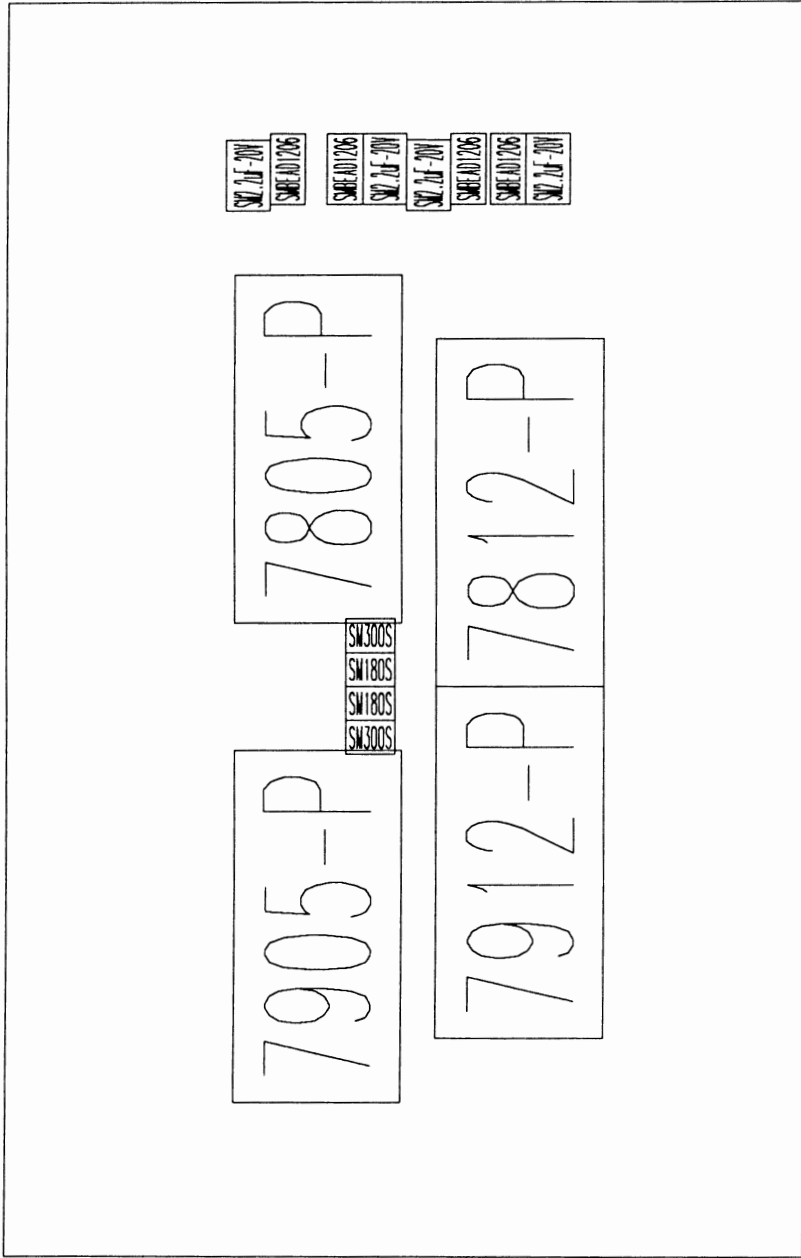

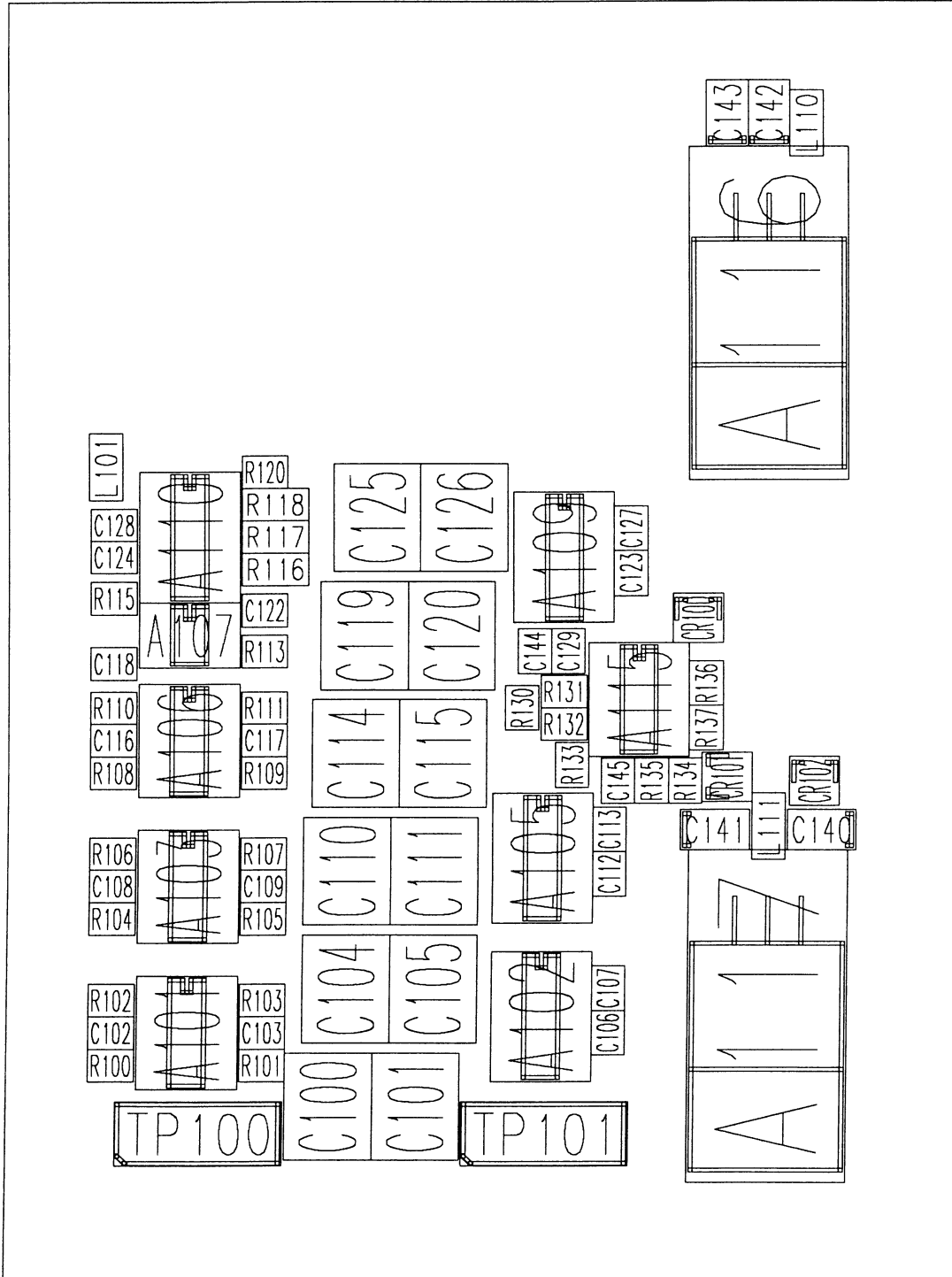

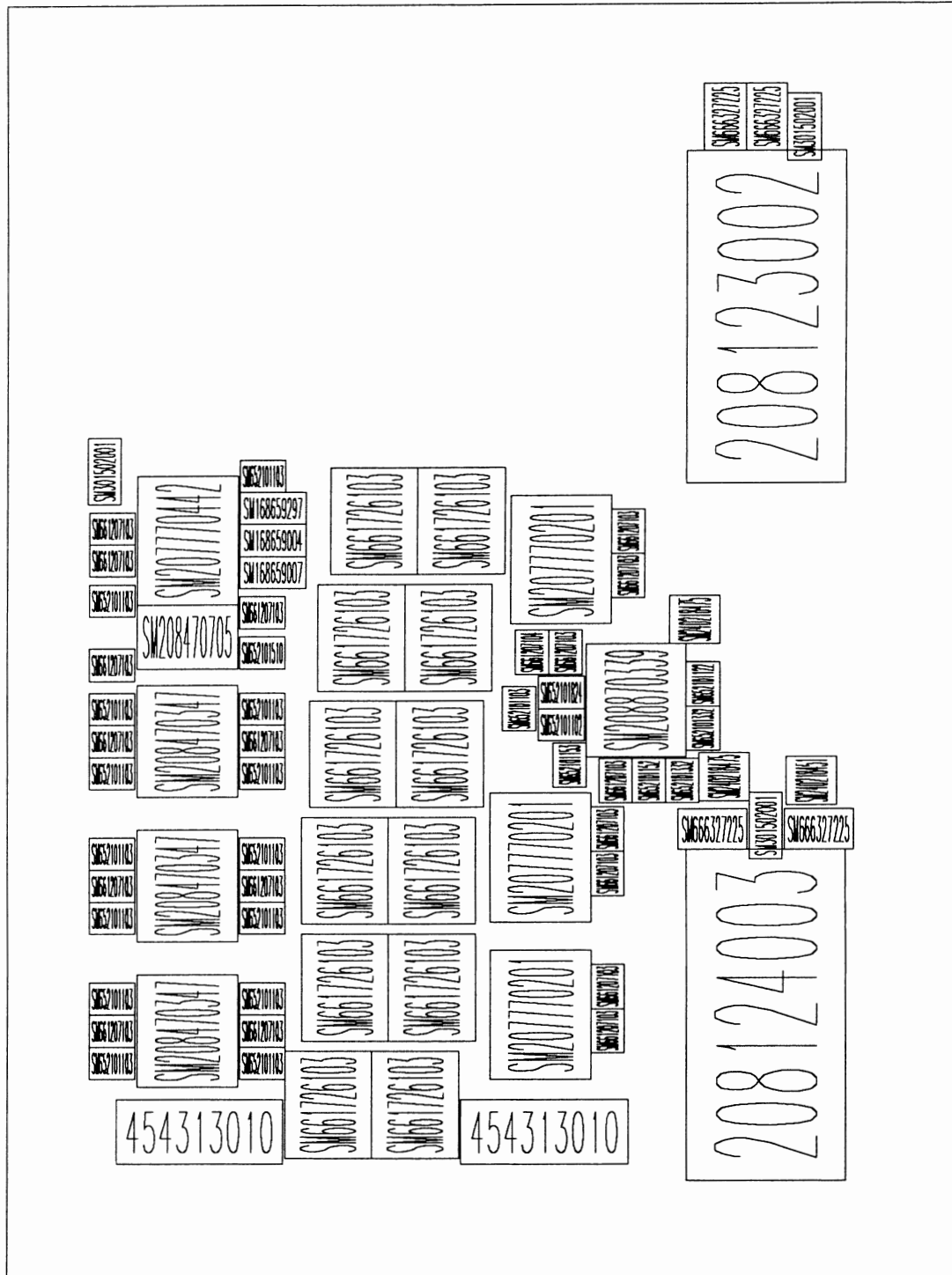

9314A-3 Rev:B

FRONT-END CHANNEL'S

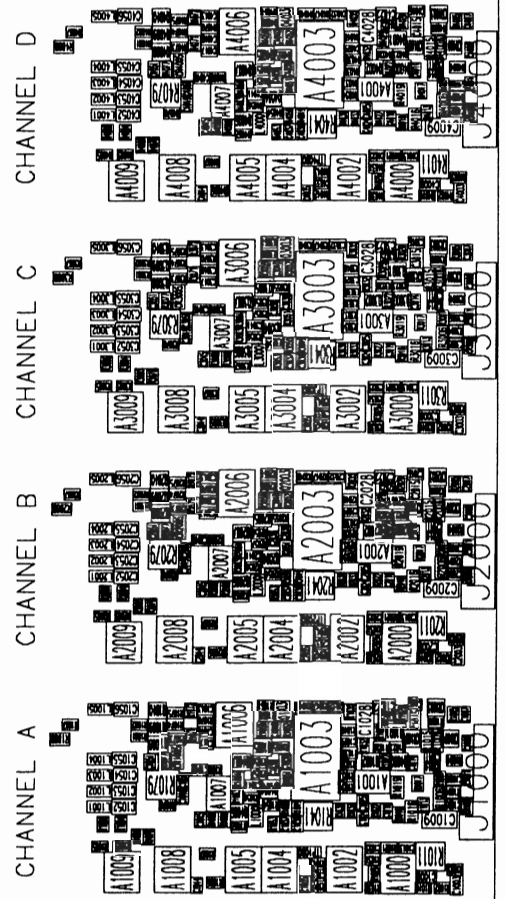

9314A-3 Rev : B

FRONT-END CHANNEL 'S

CHANNEL A CHANNEL B CHANNEL C CHANNEL D

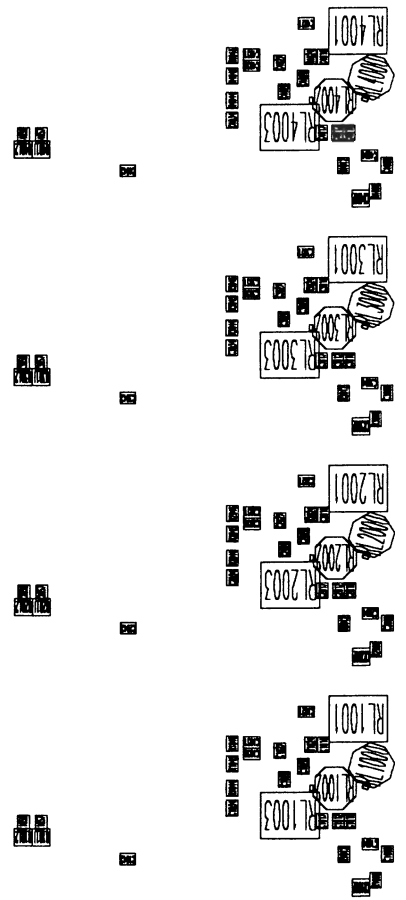

CHANNEL A

CHANNEL B

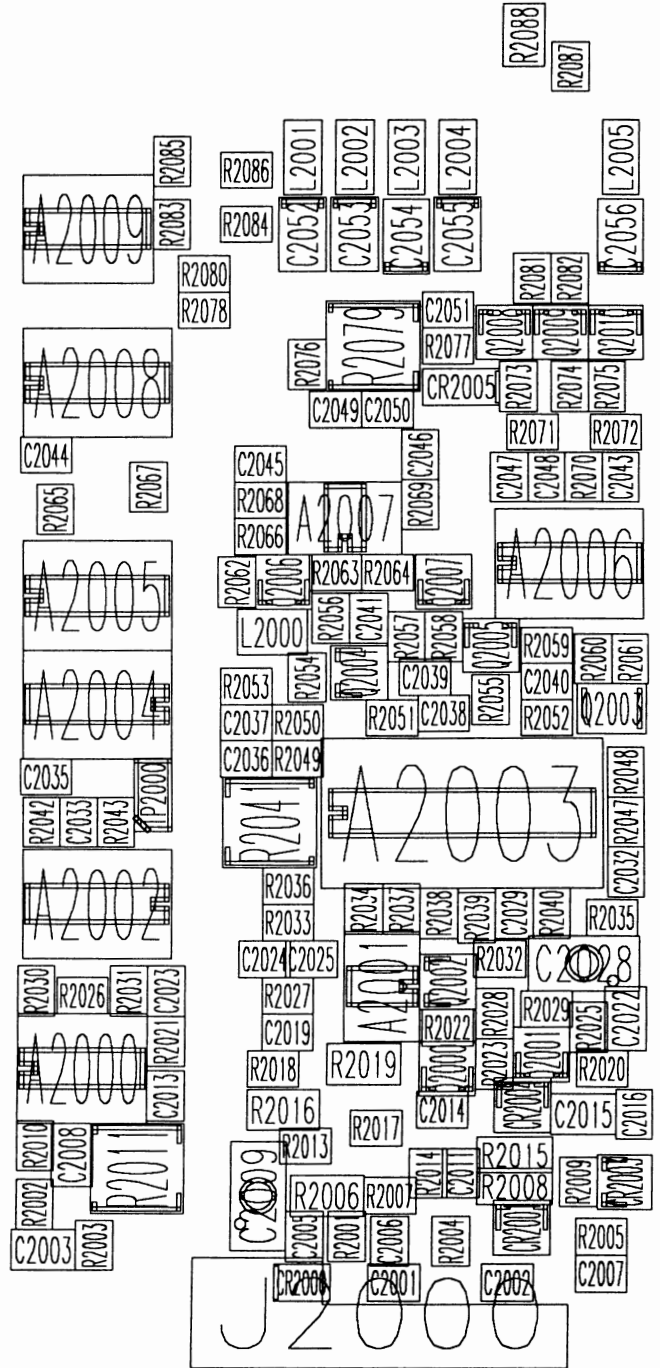
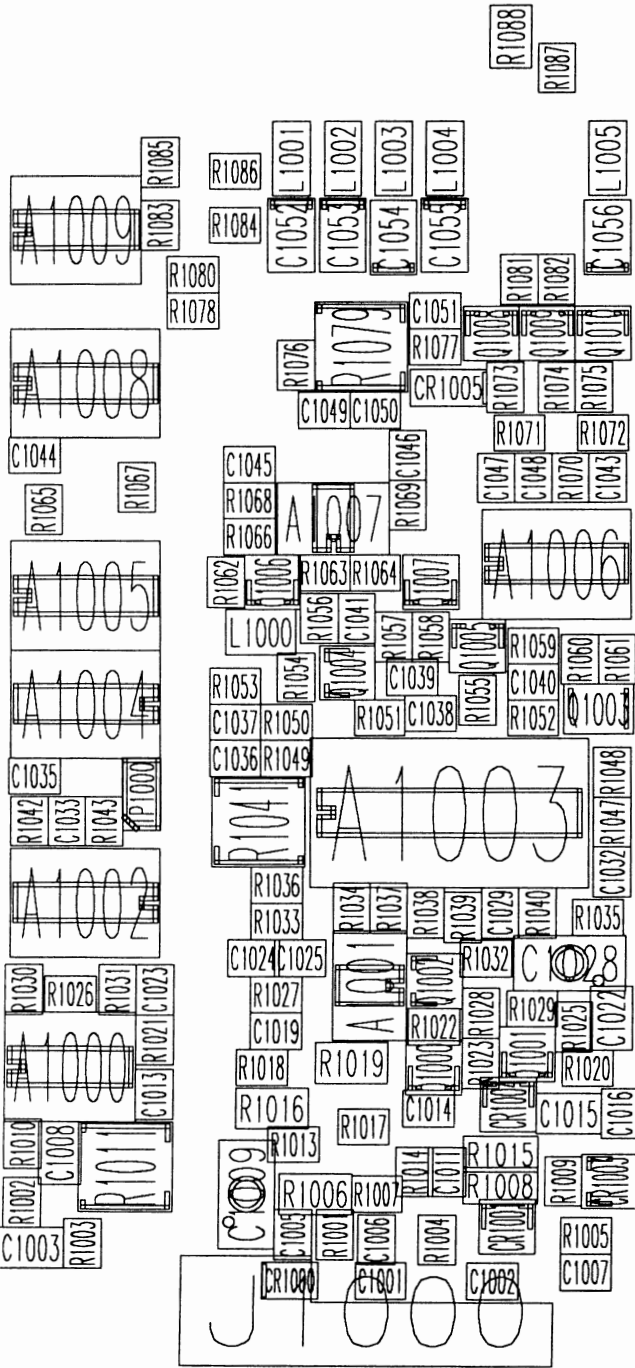

CHANNEL A

CHANNEL B

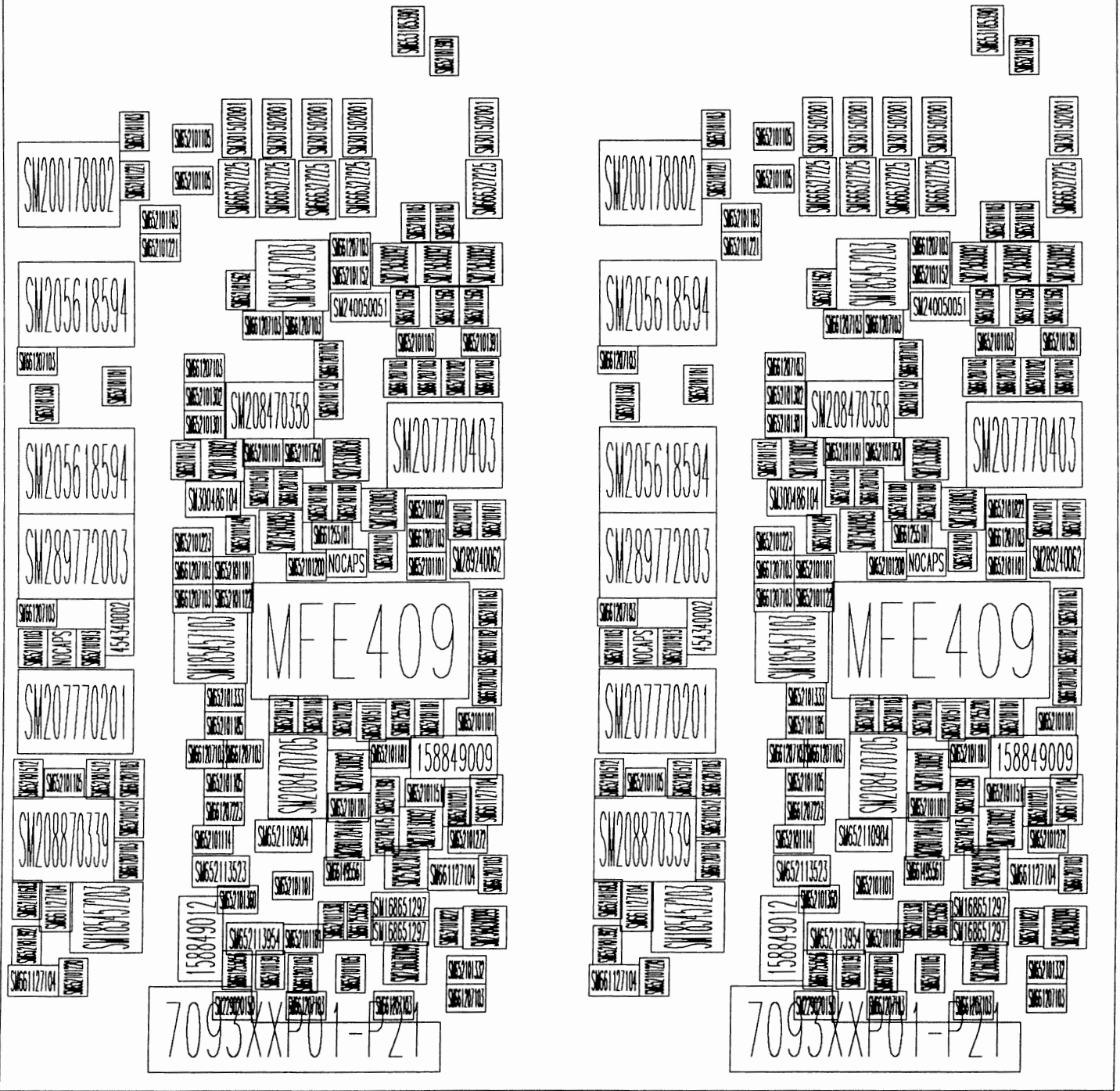

CHANNEL C

CHANNEL D

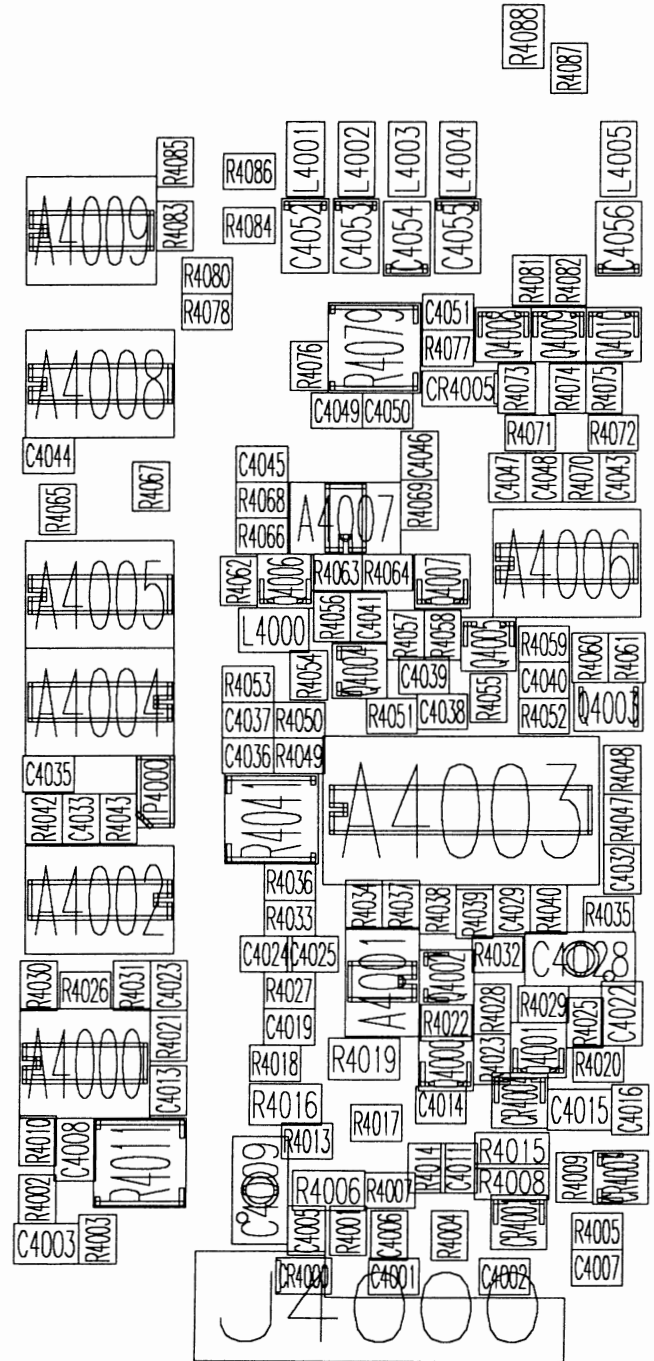
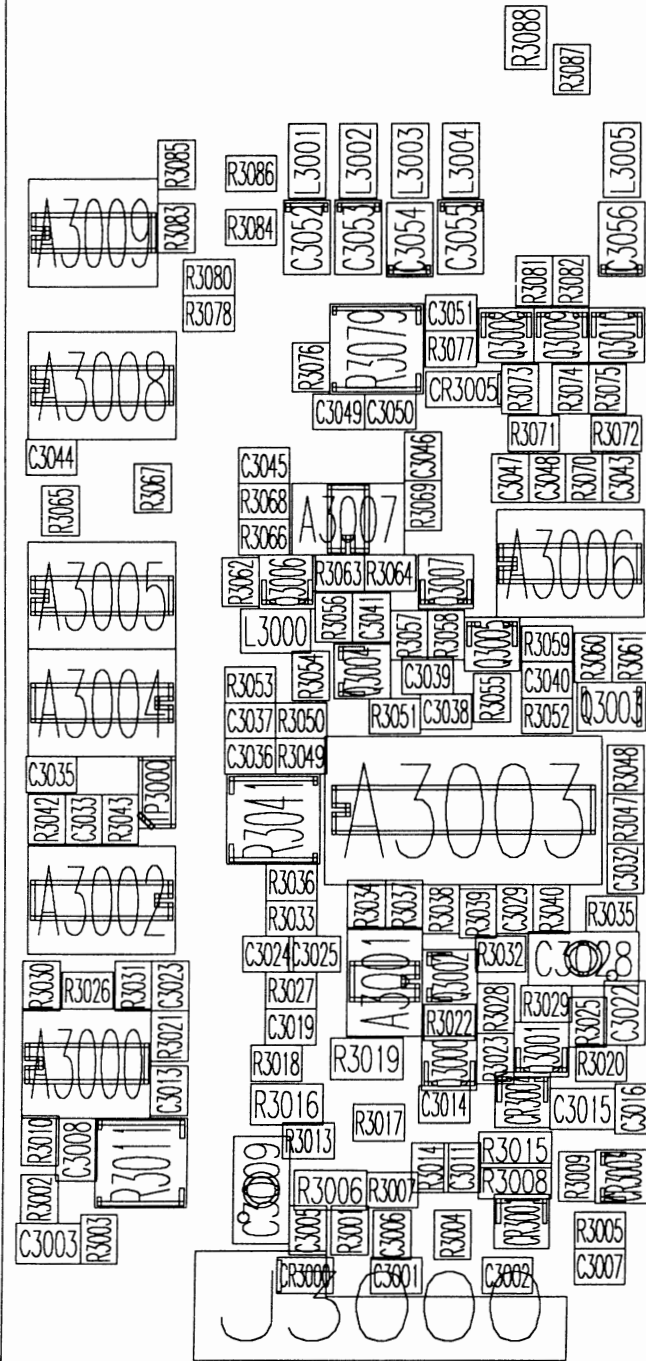

CHANNEL C

CHANNEL D

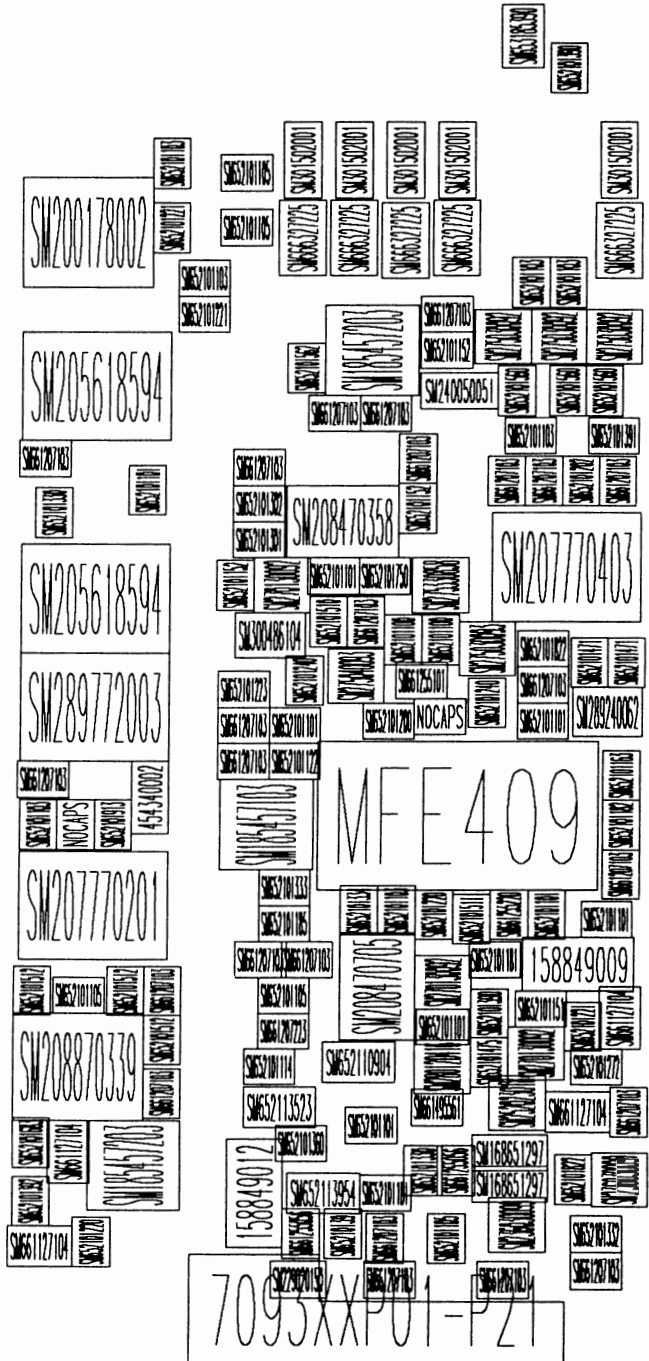
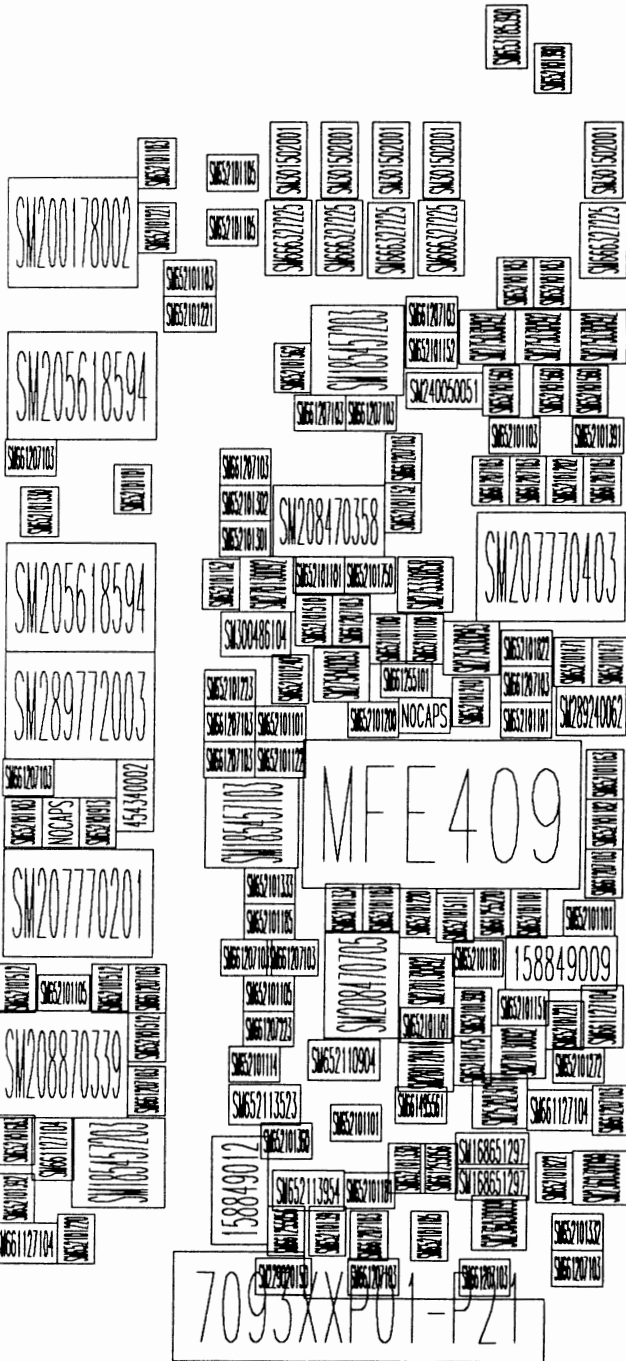

CHANNEL A

CHANNEL B

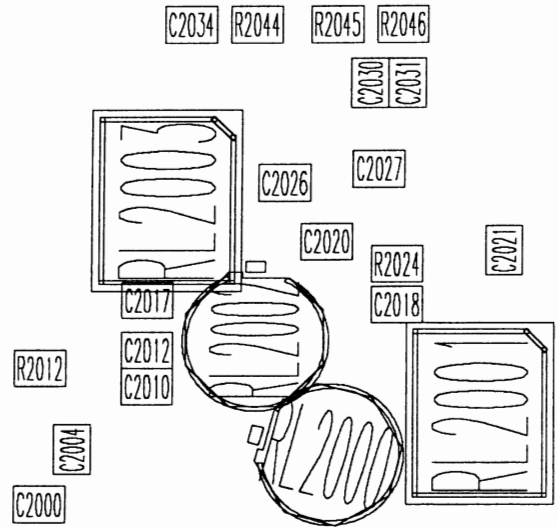
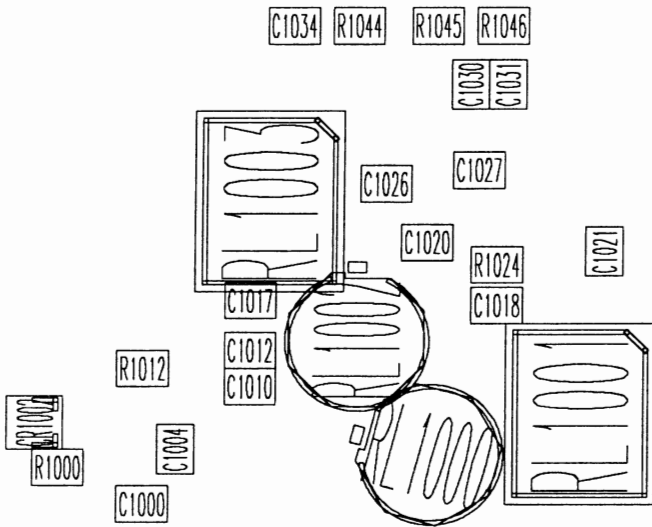
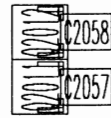
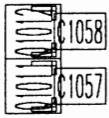

CHANNEL A

CHANNEL B

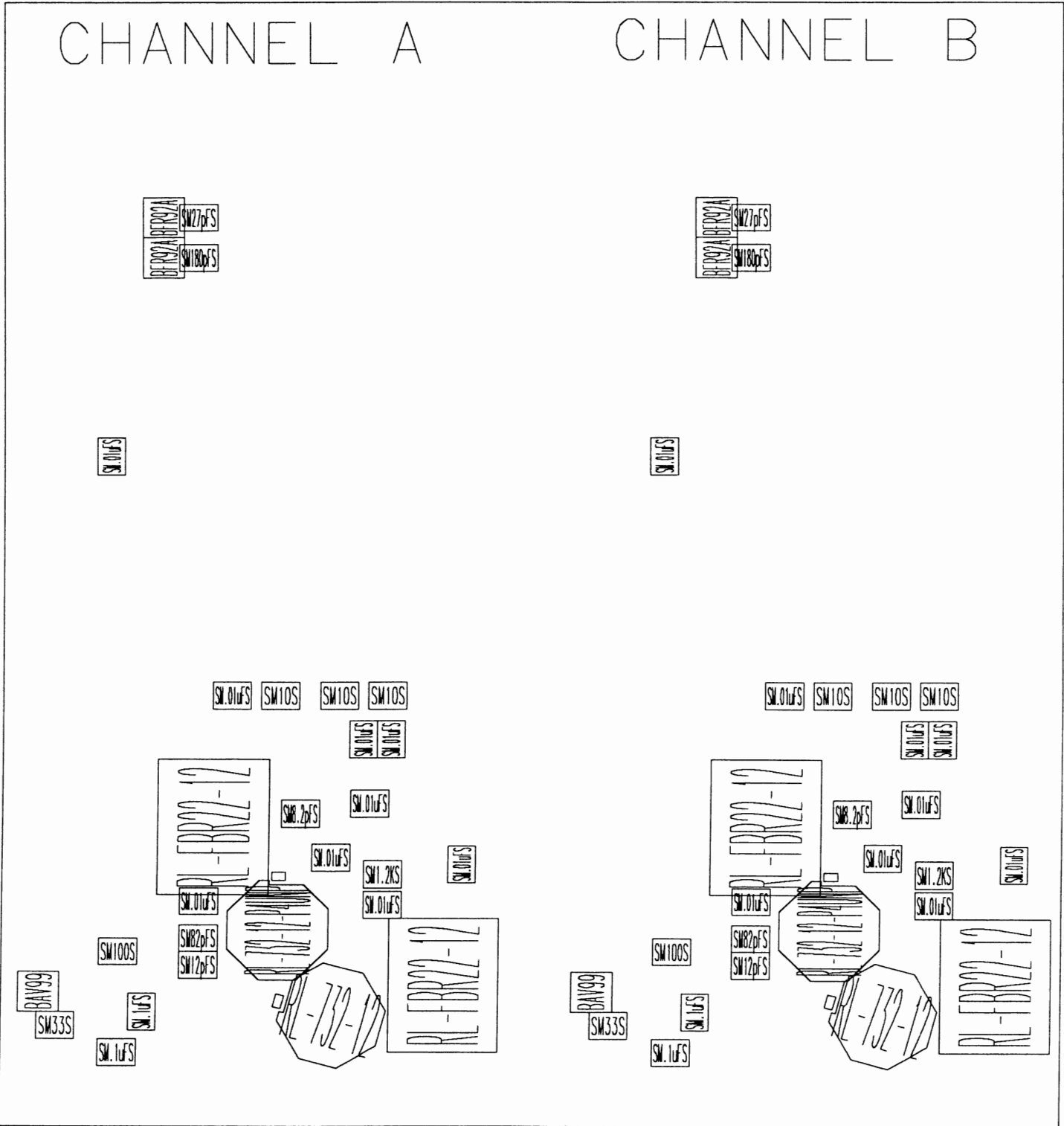

CHANNEL C

CHANNEL D

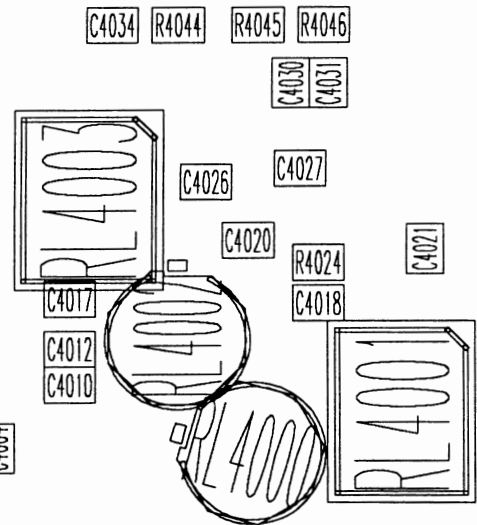
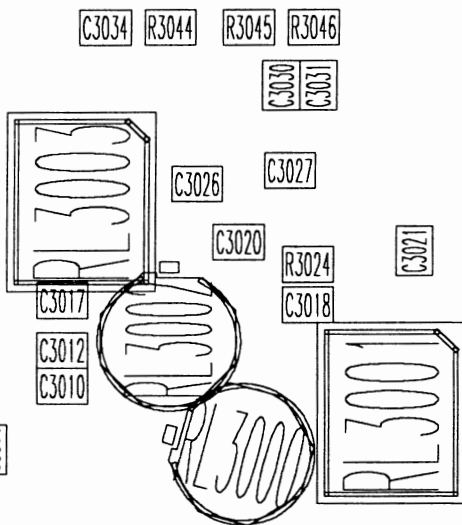
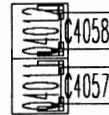
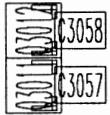

CHANNEL C

CHANNEL D

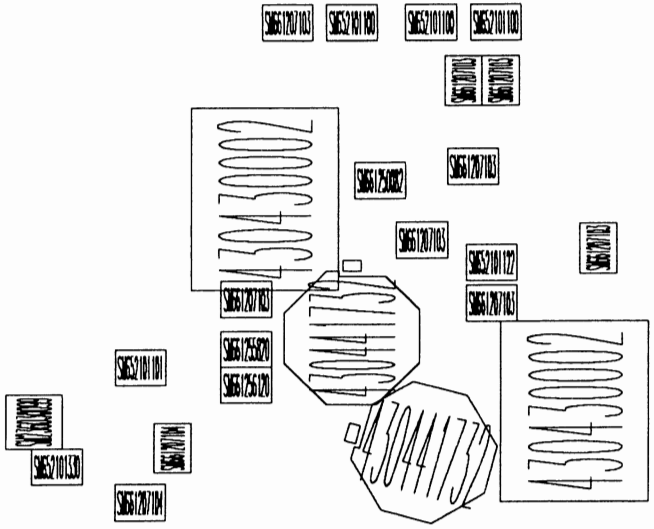
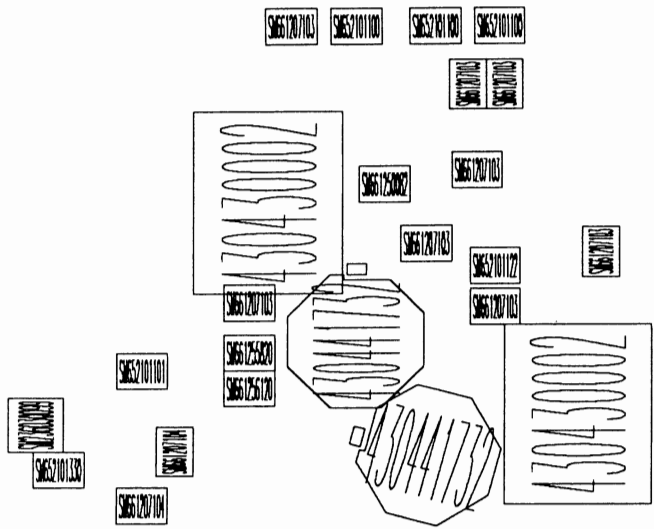
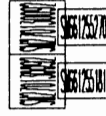

CHANNEL C

CHANNEL D

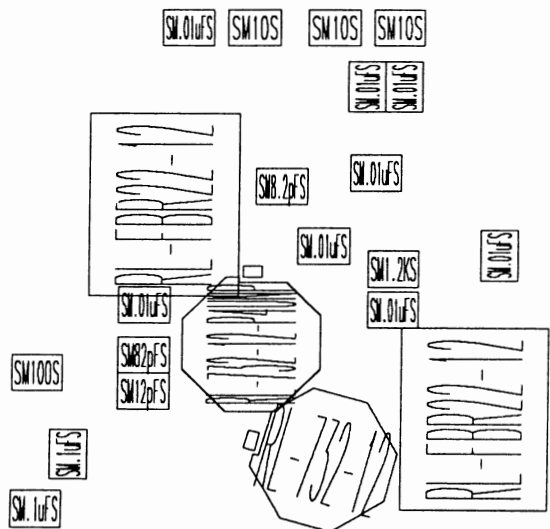
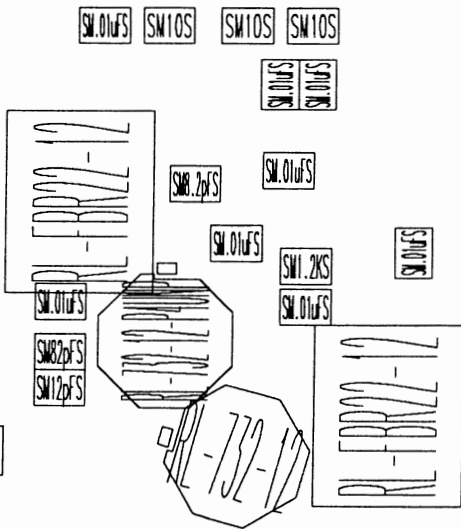
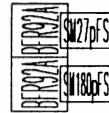
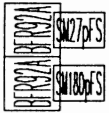

9314A-3 Rev: B

TRIGGER + PROBE CALIBRATOR

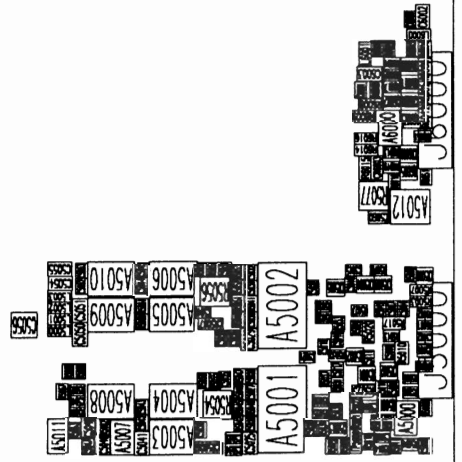

TRIGGER + PROBE CALIBRATOR

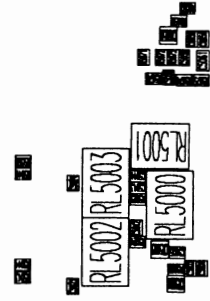

9314A-3 Rev: B

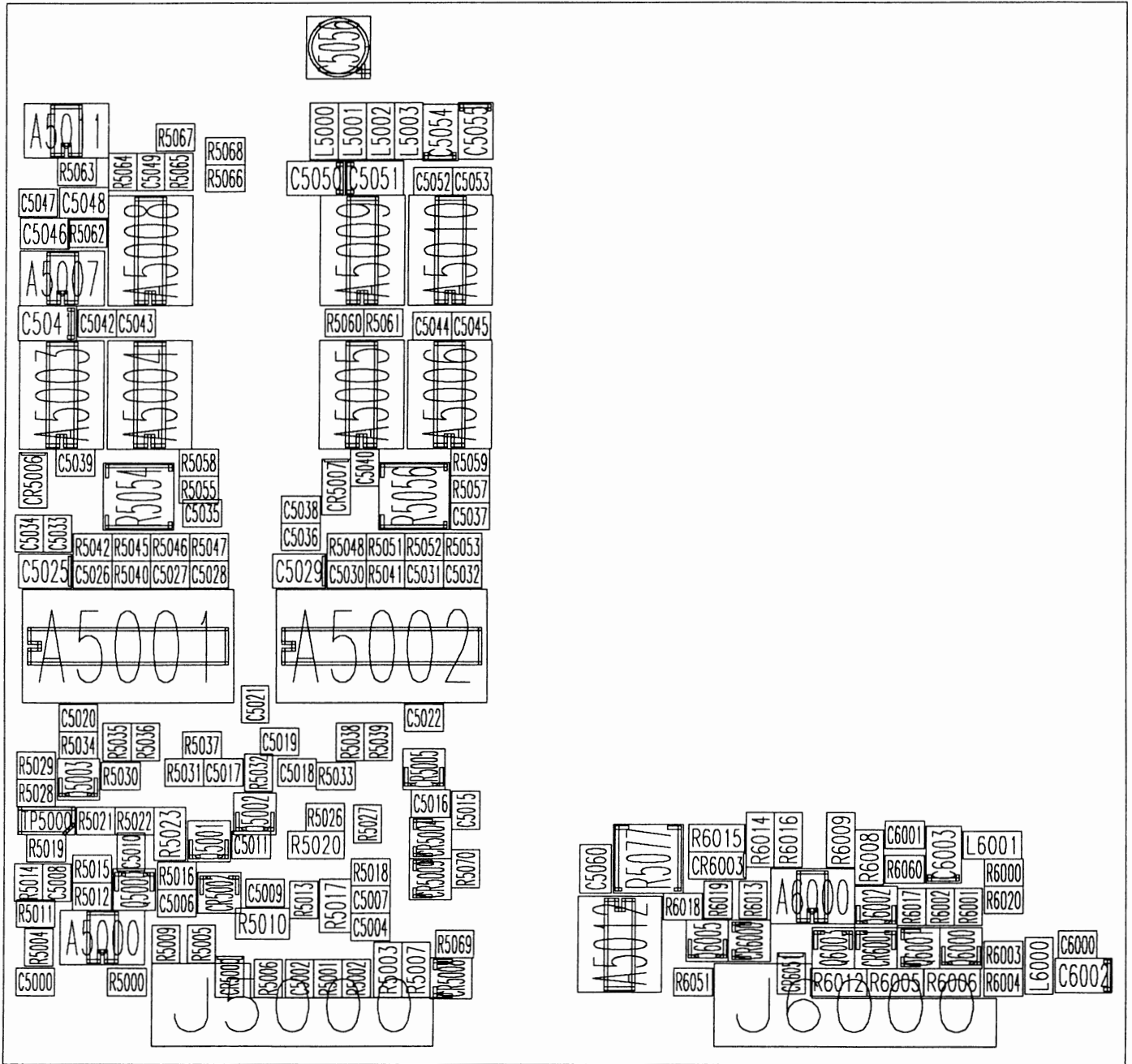

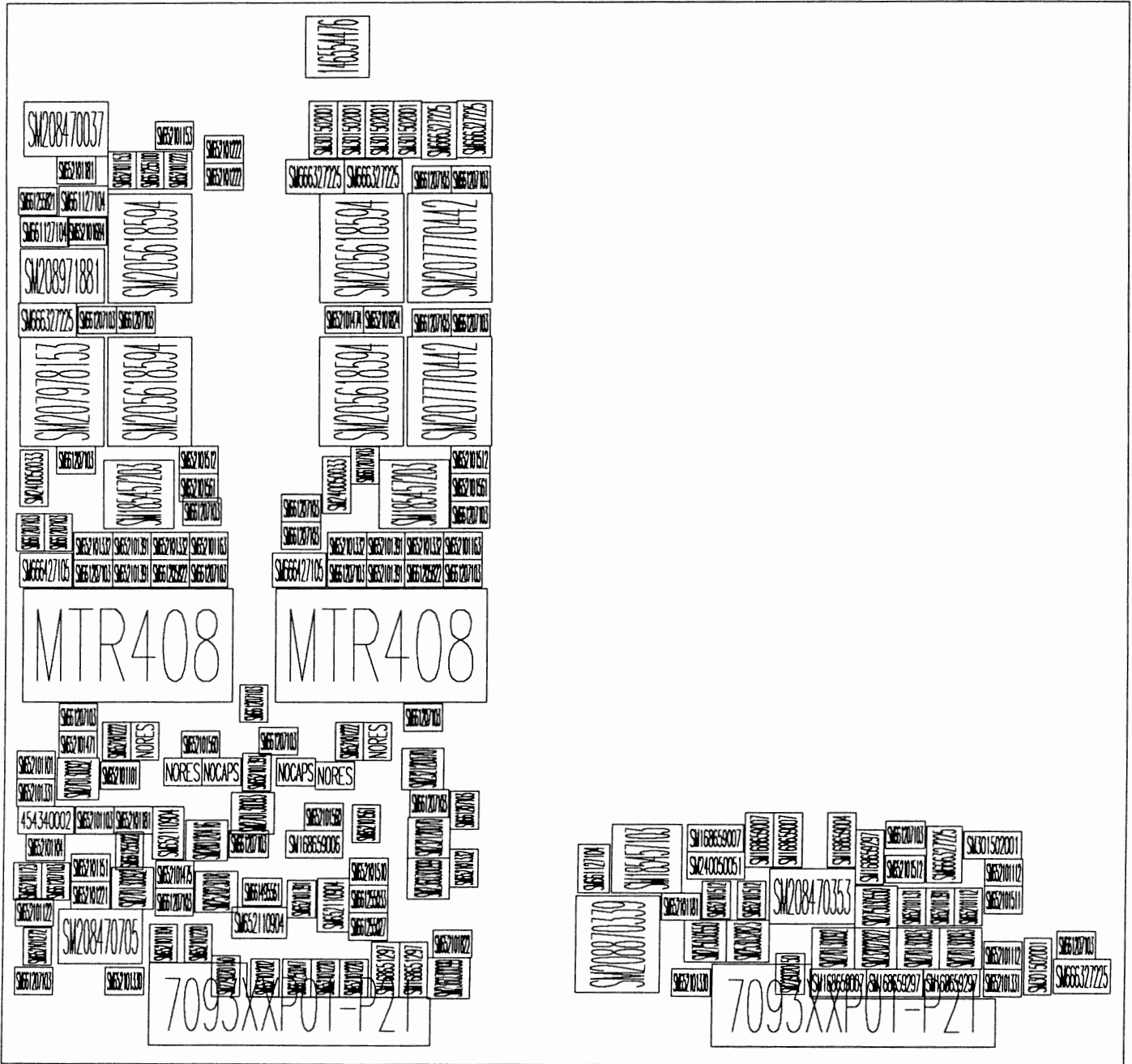

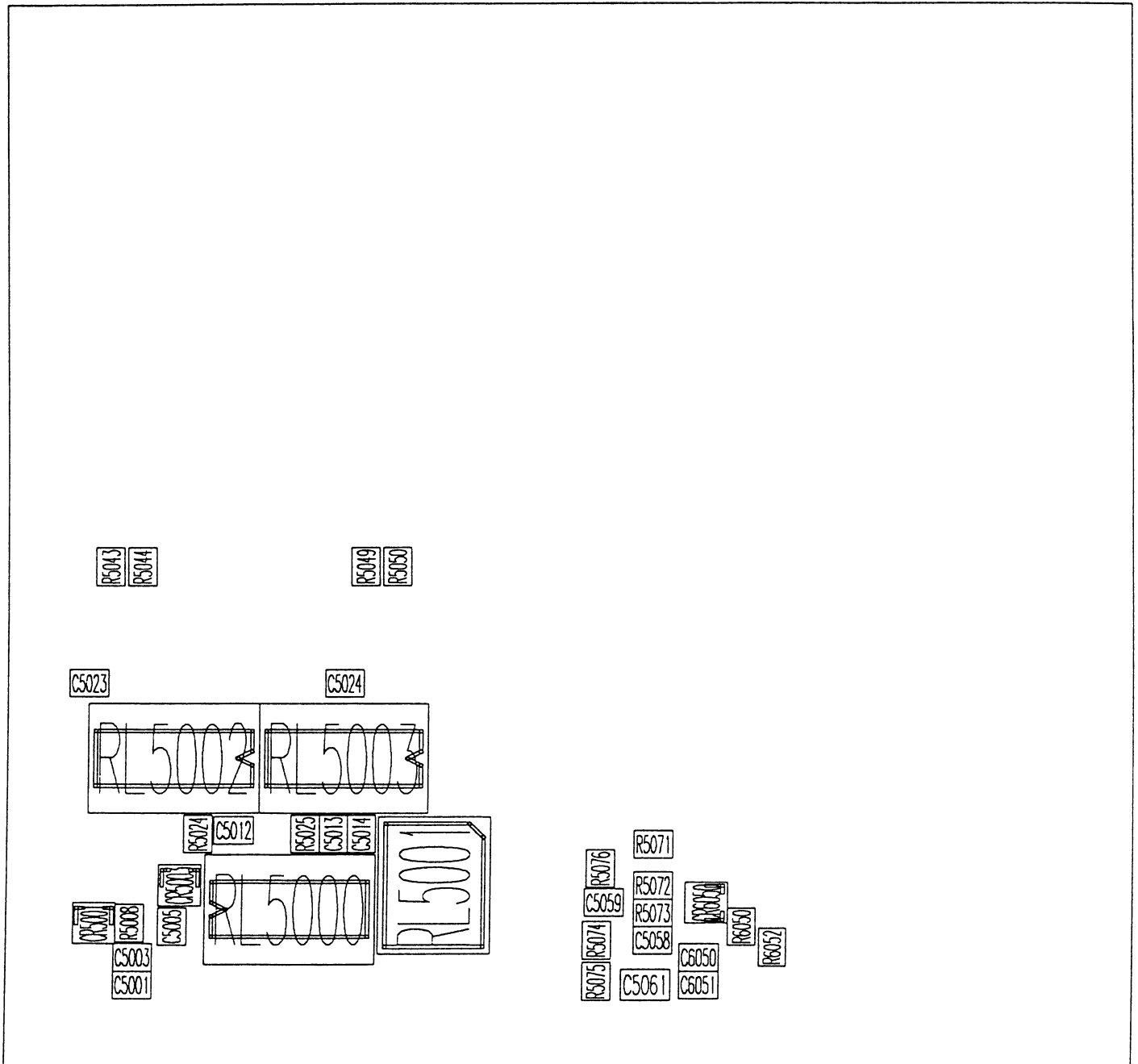

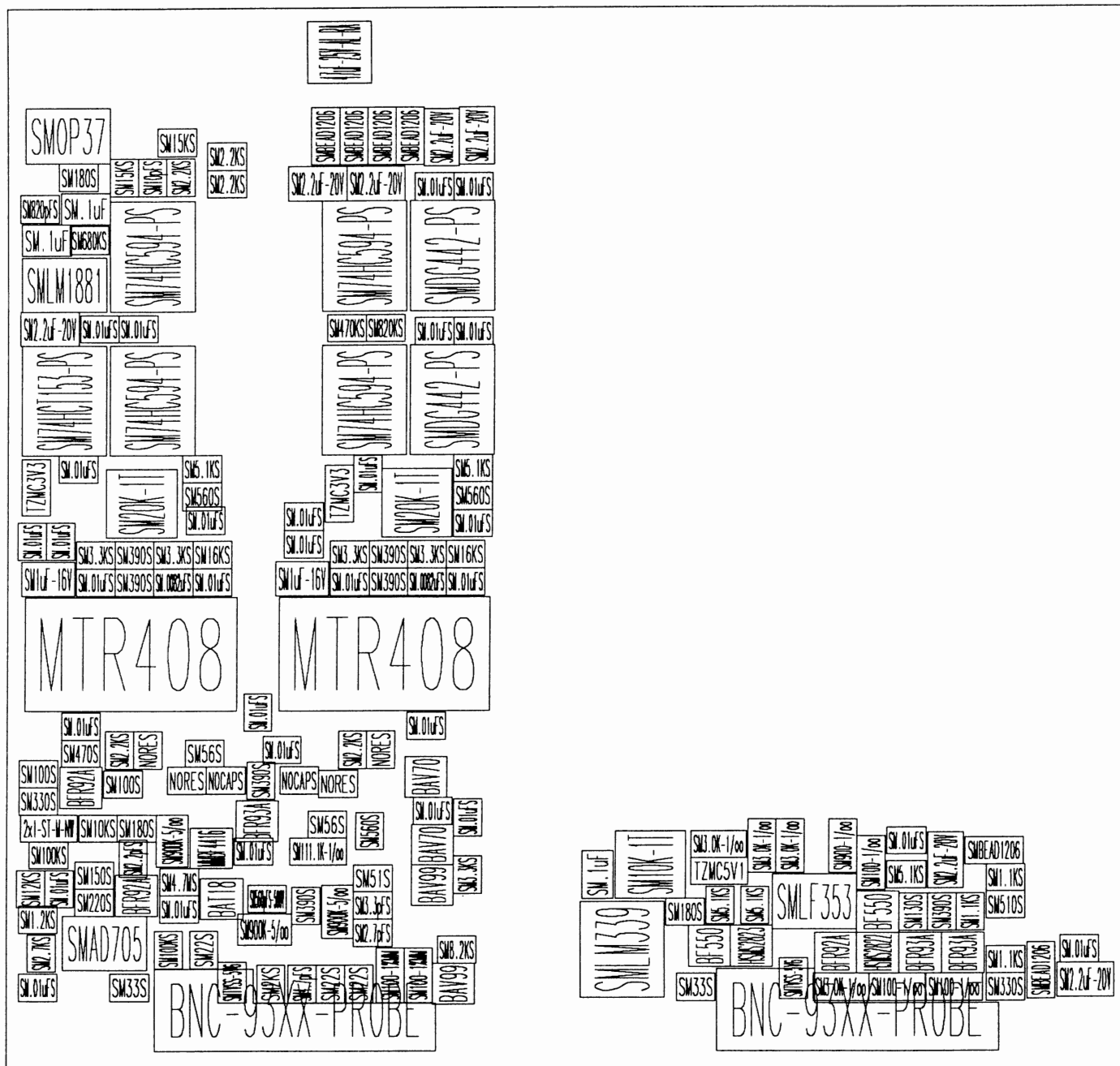

9314A-3 Rev:B

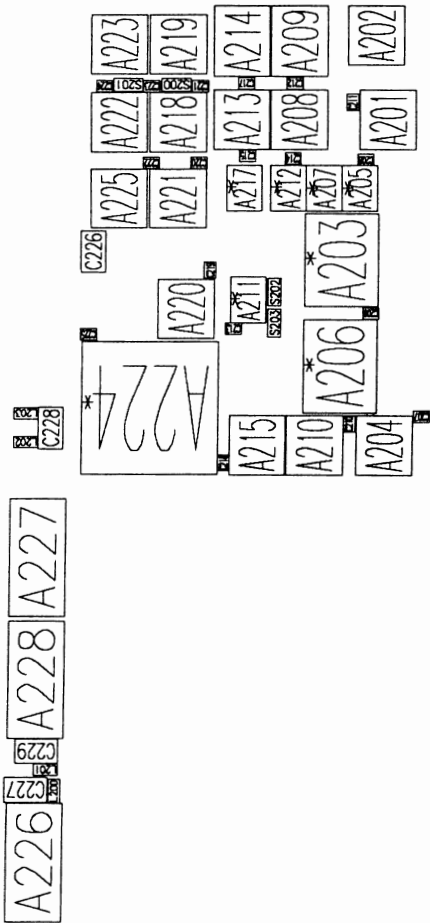

* THE FOLLOWING COMPONENTS A203, A205, A206, A207, A211, A212, A217, A224 ARE ONLY MOUNTED IN THE DSO'S MODEL 9314AM AND 9314AL.

THESE COMPONENTS ARE NOT USED IN THE 9314A STANDARD VERSION.

ADC CONTROL

A200 C204

C201 C203

TP200 C200 C202

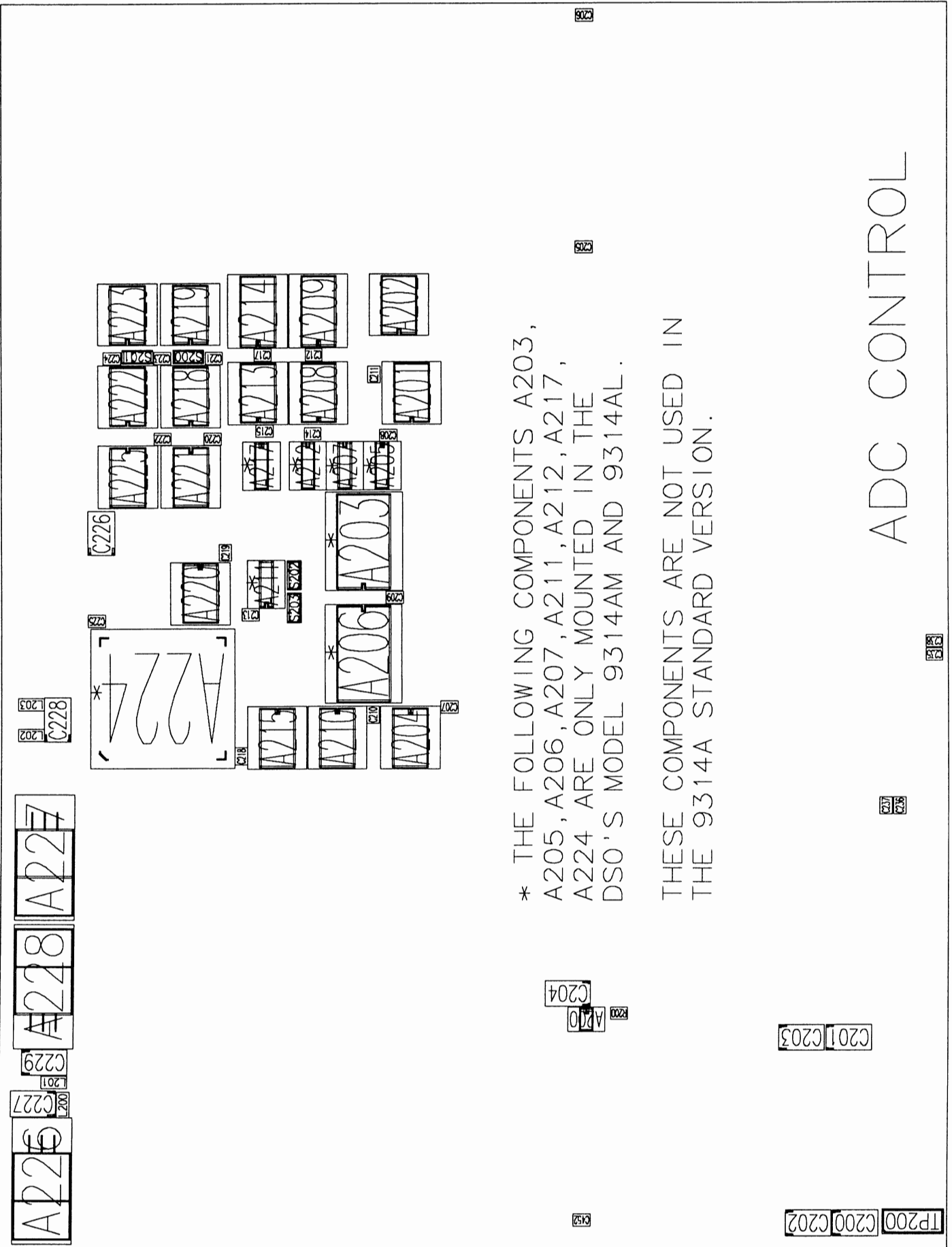

ADC CONTROL

* THE FOLLOWING COMPONENTS A203, A205, A206, A207, A211, A212, A217, A224 ARE ONLY MOUNTED IN THE DSO'S MODEL 9314AM AND 9314AL. THESE COMPONENTS ARE NOT USED IN THE 9314A STANDARD VERSION.

208123002
 208124003
 208122002

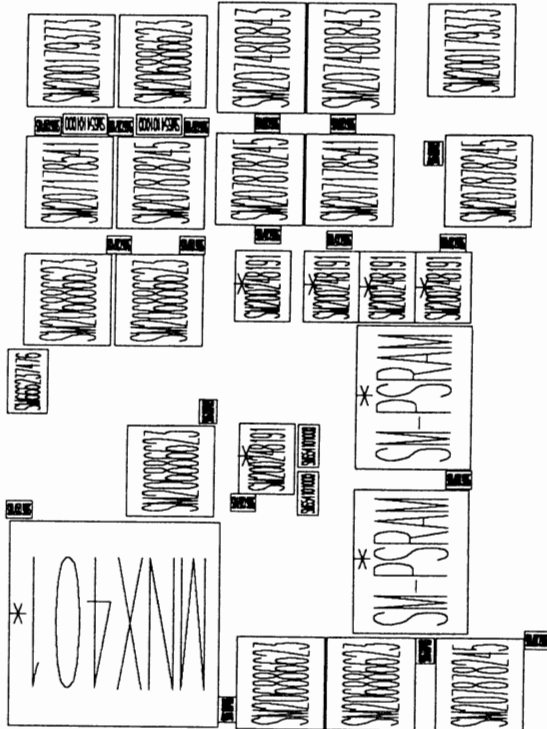

* THE FOLLOWING COMPONENTS A203, A205, A206, A207, A211, A212, A217, A224 ARE ONLY MOUNTED IN THE DSO'S MODEL 9314AM AND 9314AL.

THESE COMPONENTS ARE NOT USED IN THE 9314A STANDARD VERSION.

ADC CONTROL

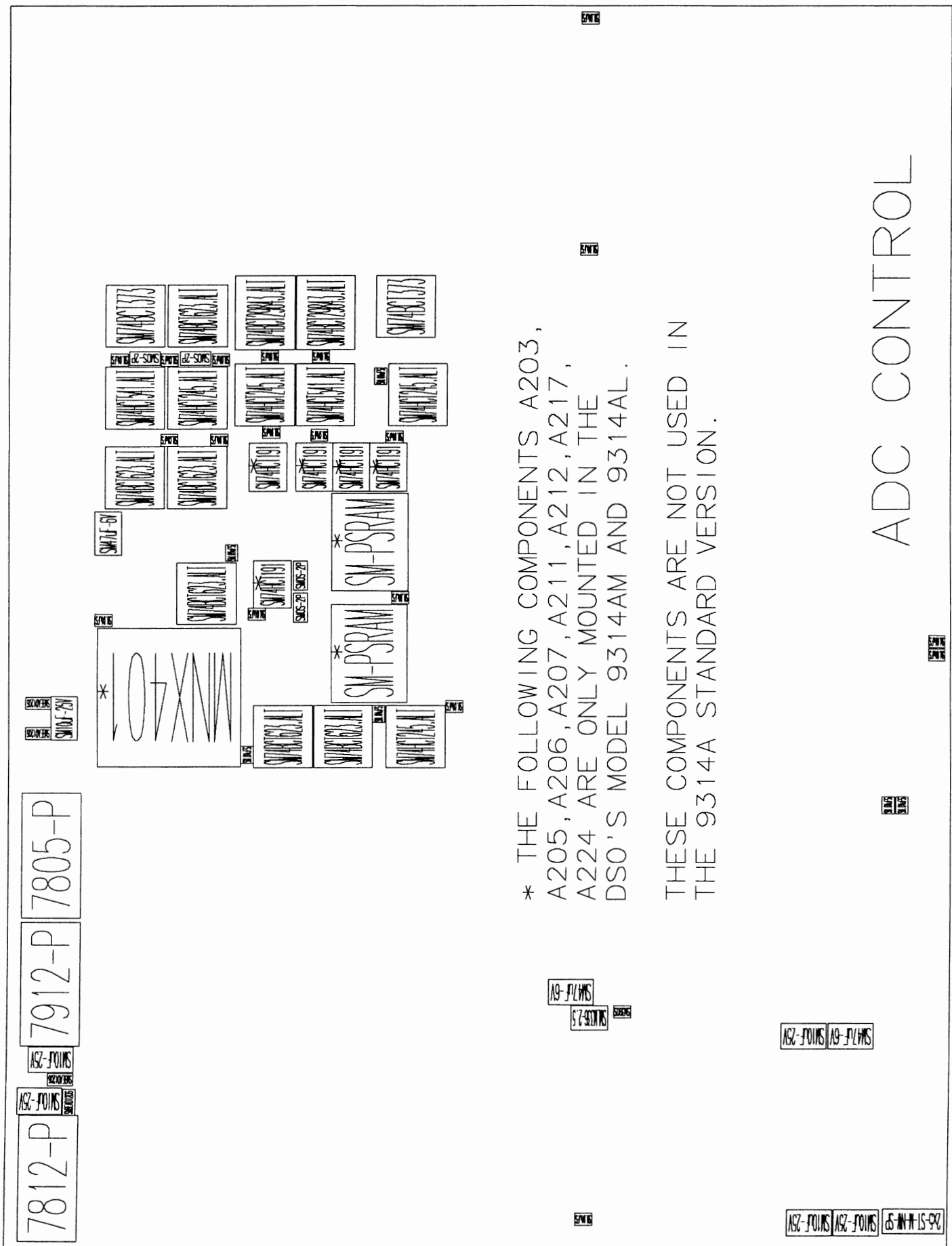

* THE FOLLOWING COMPONENTS A203, A205, A206, A207, A211, A212, A217, A224 ARE ONLY MOUNTED IN THE DSO'S MODEL 9314AM AND 9314AL.

THESE COMPONENTS ARE NOT USED IN THE 9314A STANDARD VERSION.

ADC CONTROL

9314A-3 Rev: B

MODEL :	AX506 T0 AX513 OR SRAM9314-3
9314A	2K X8 SM205210128
9314AM	8K X8 SM205219264
9314AL	128K X8 SM205701070

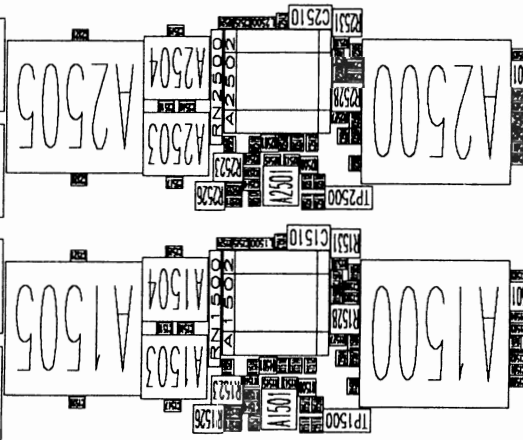
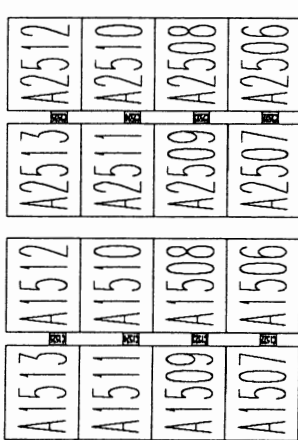

CHANNEL A

CHANNEL B

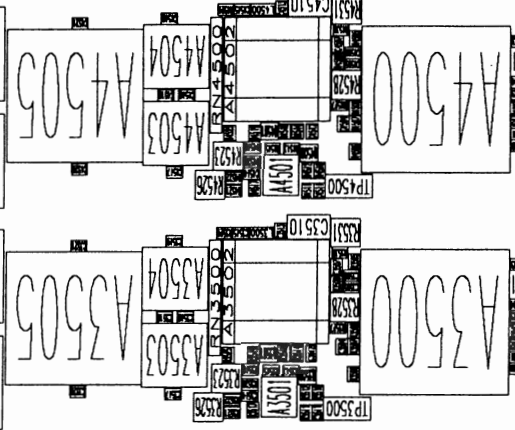
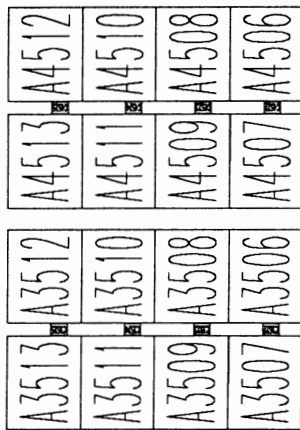

CHANNEL C

CHANNEL D

ADC CHANNEL 'S

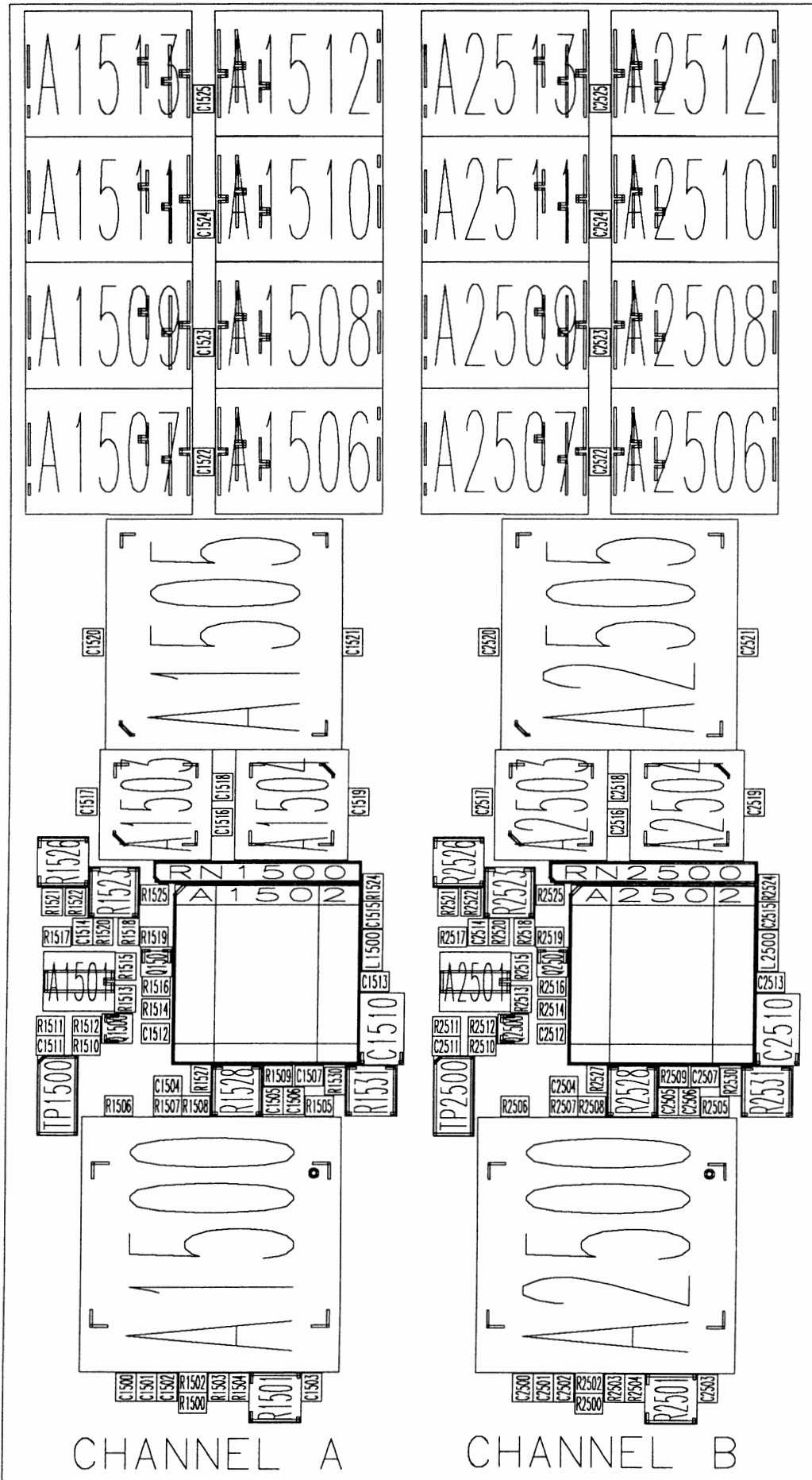

CHANNEL A

CHANNEL B

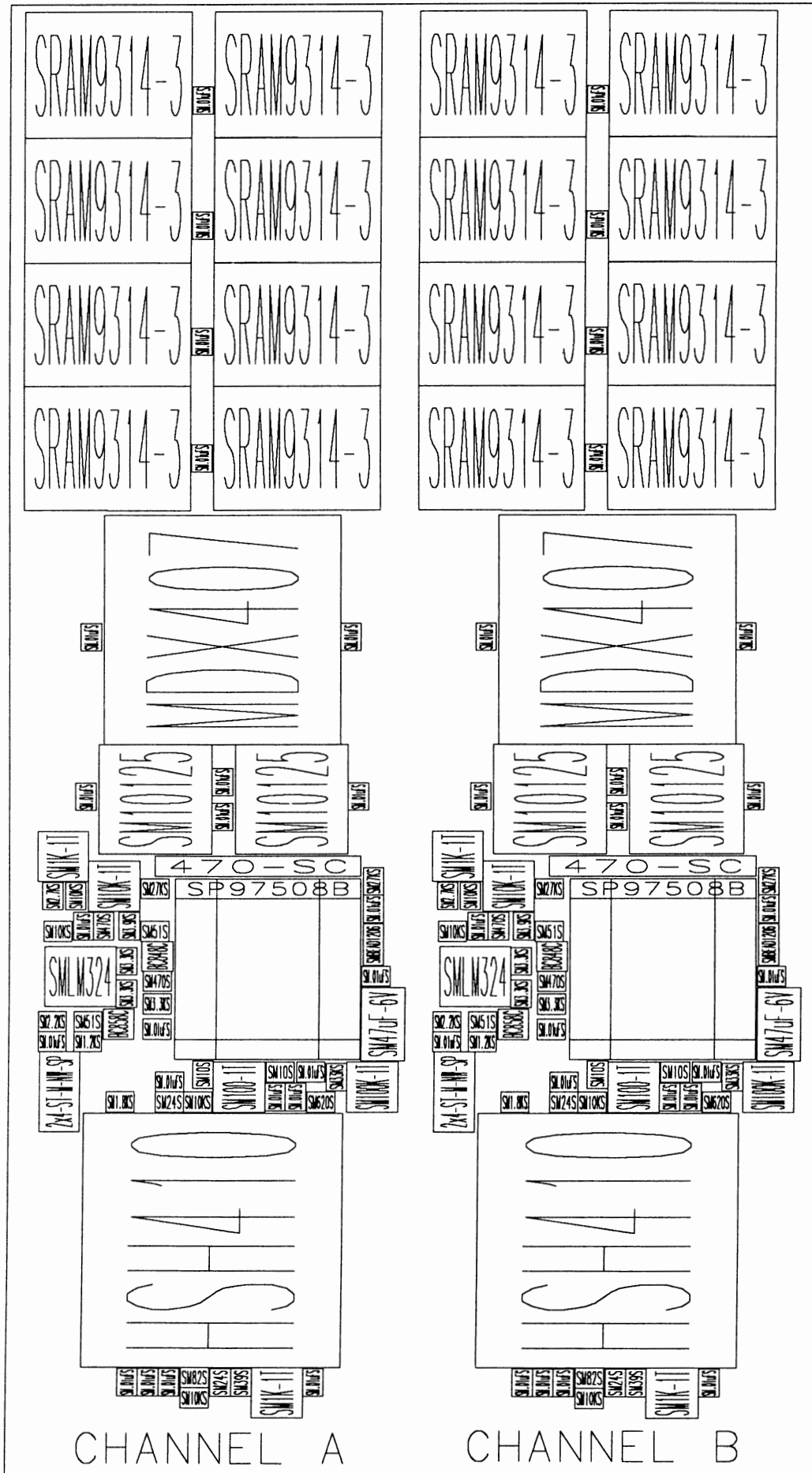

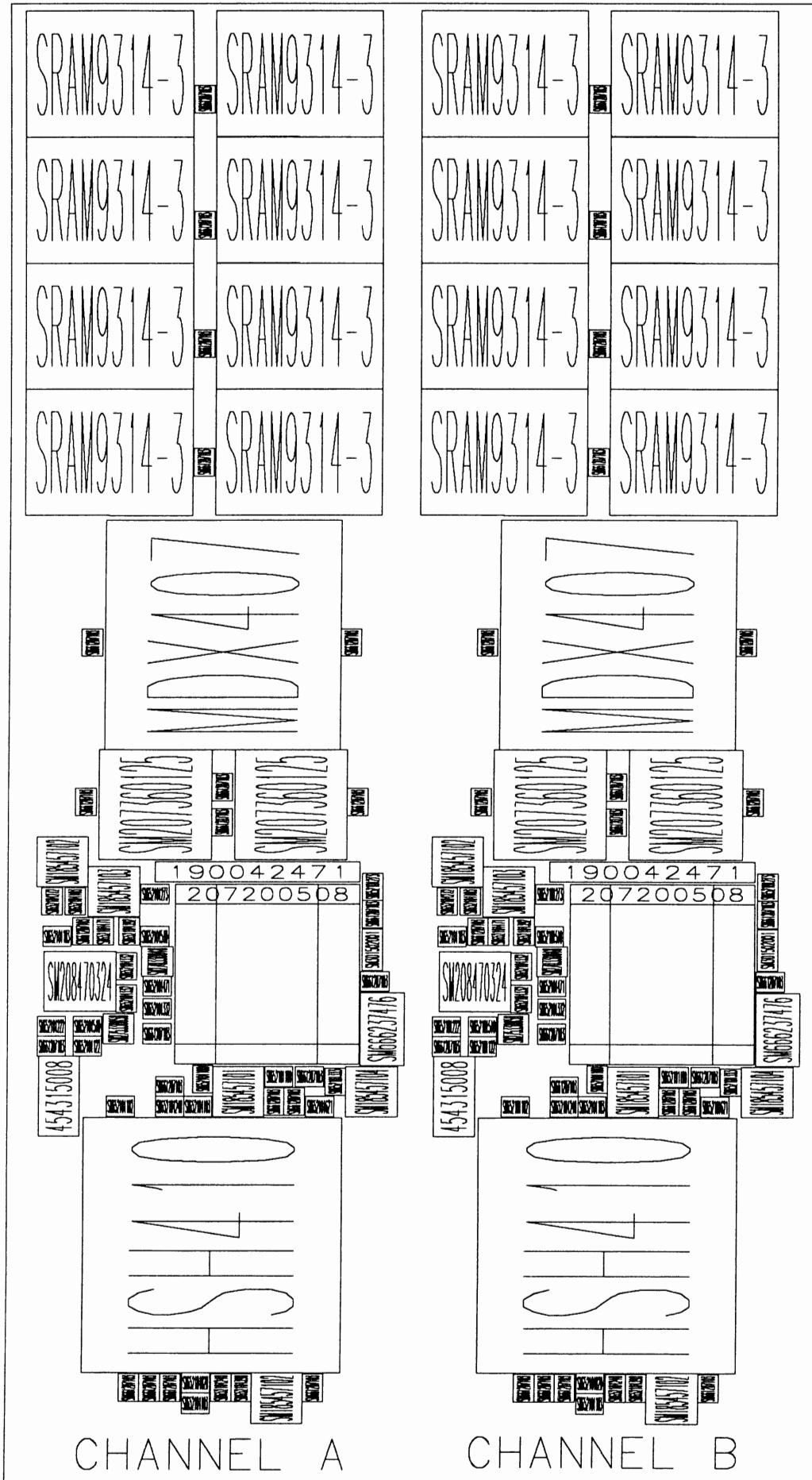

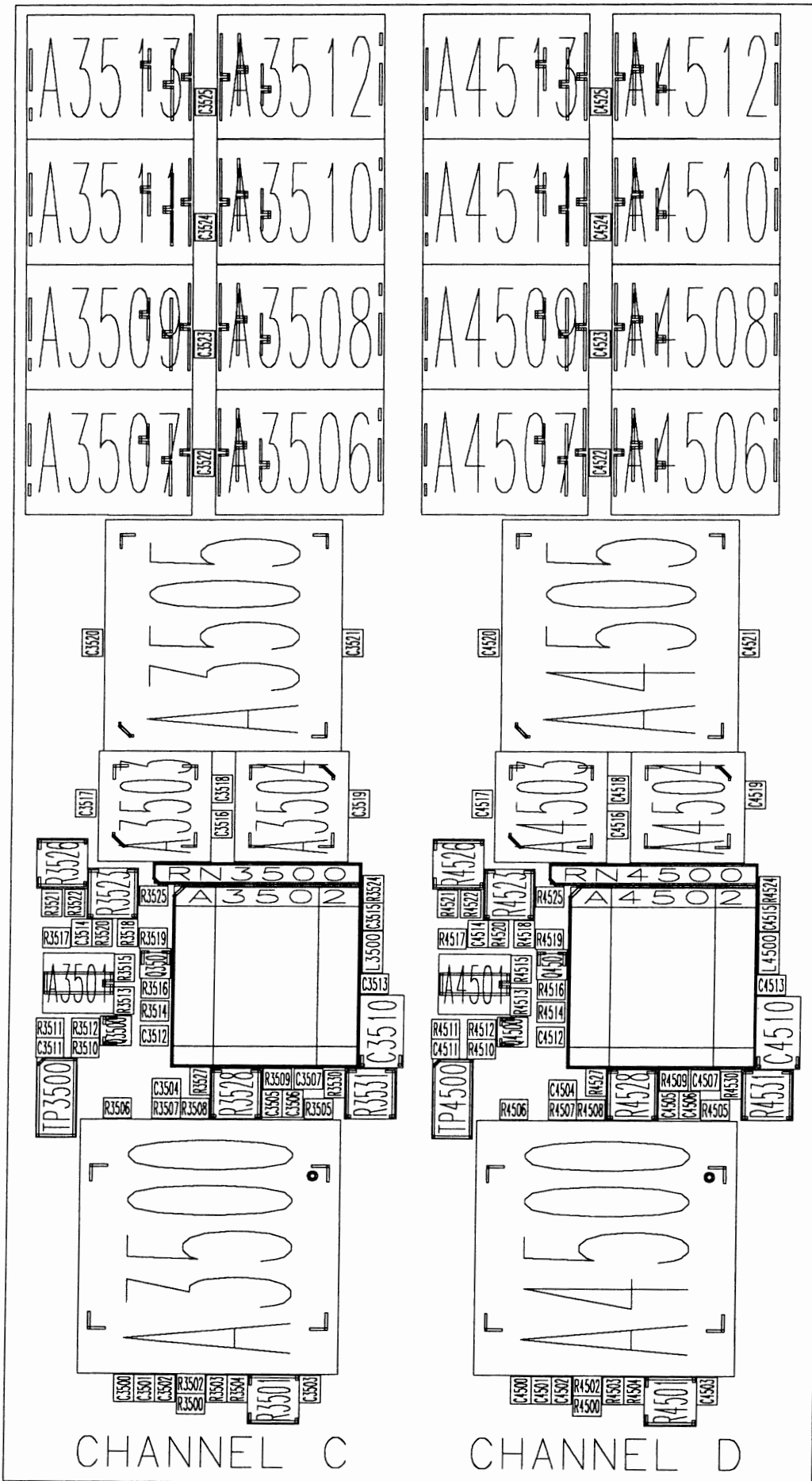

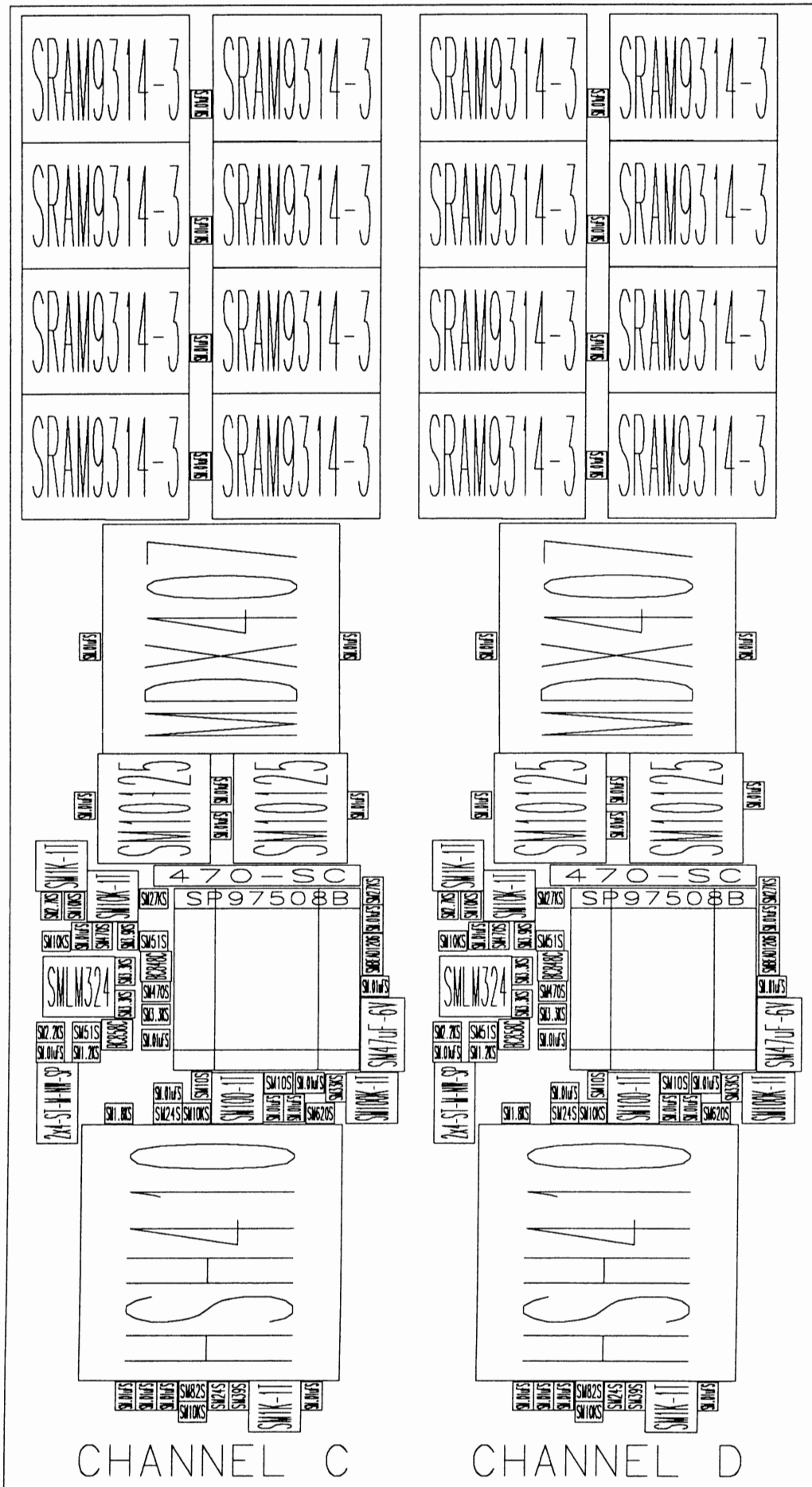

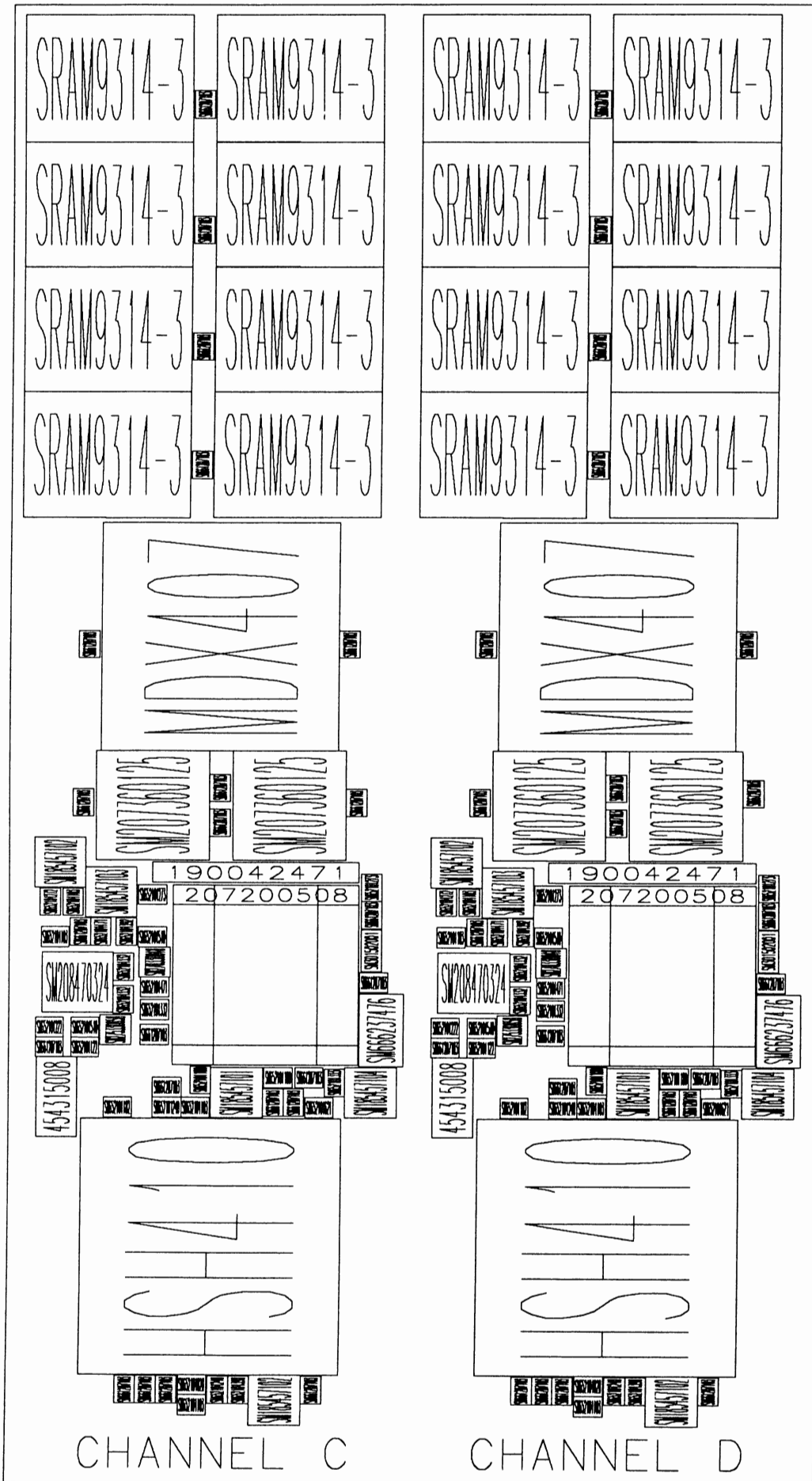

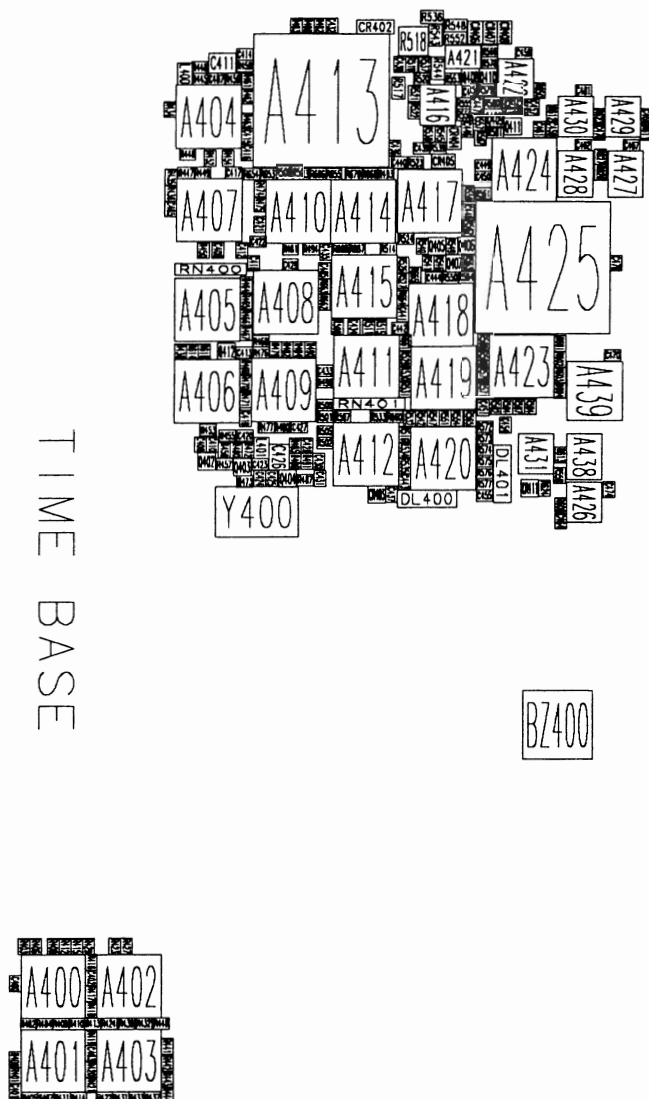

TIME BASE

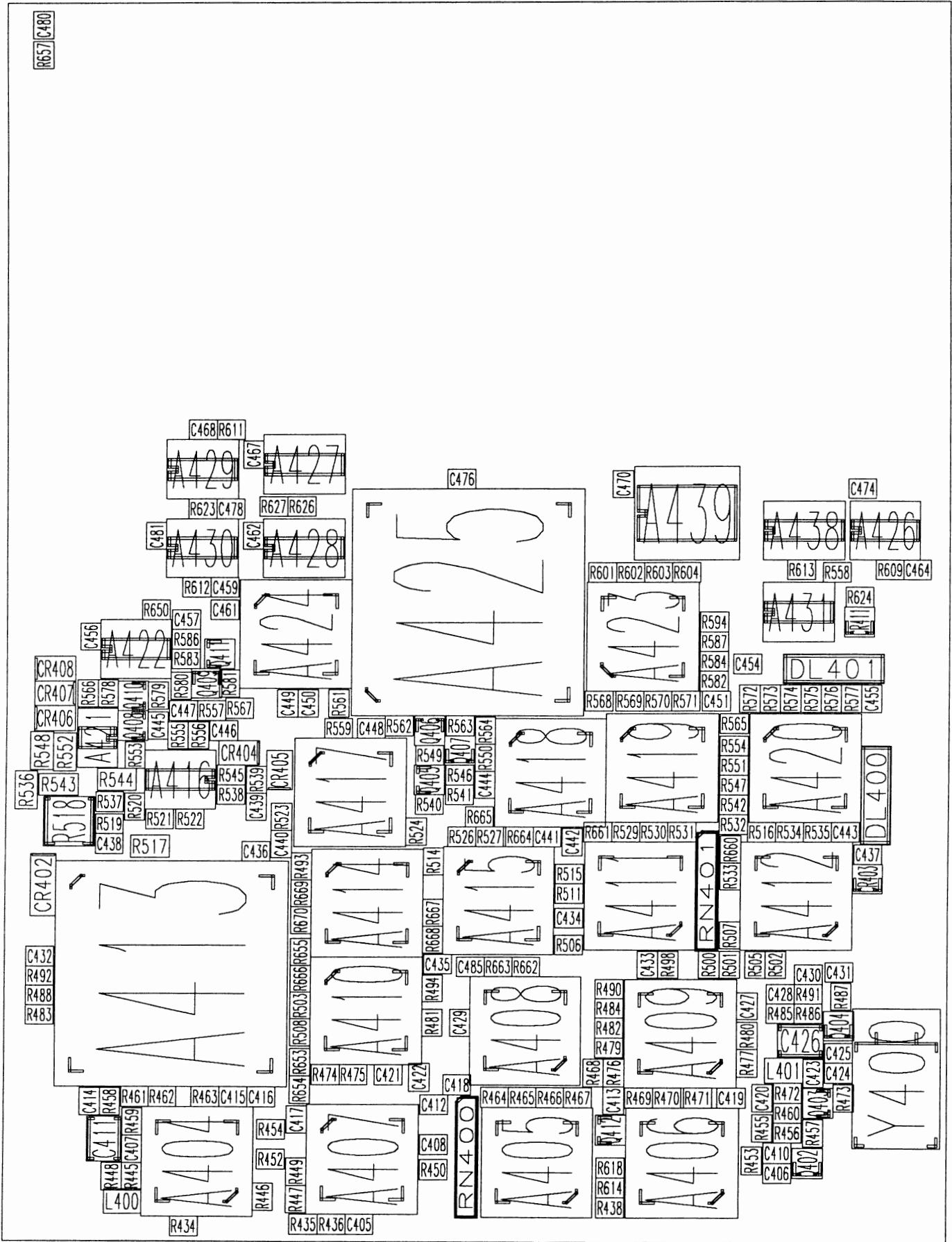

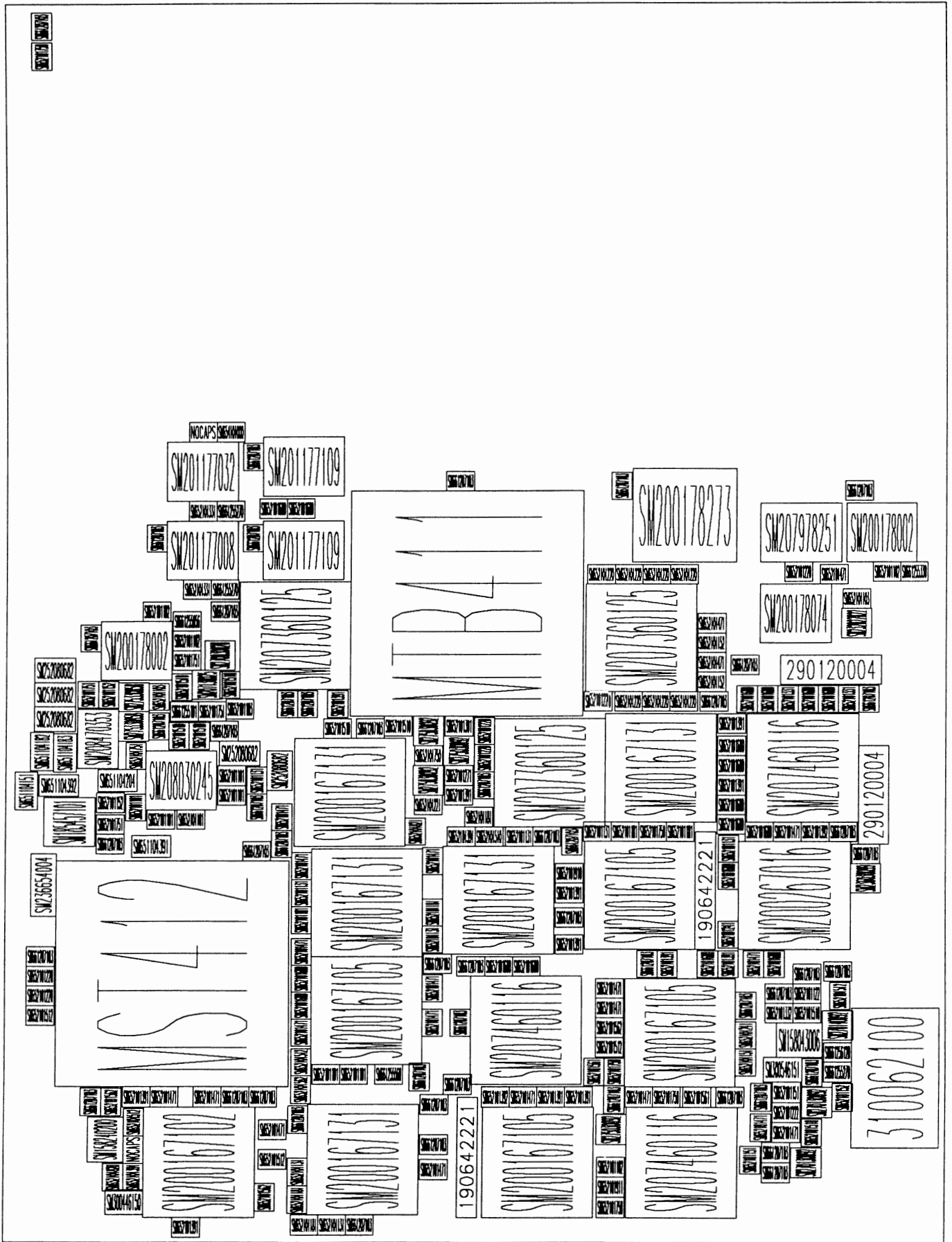

HMB-06

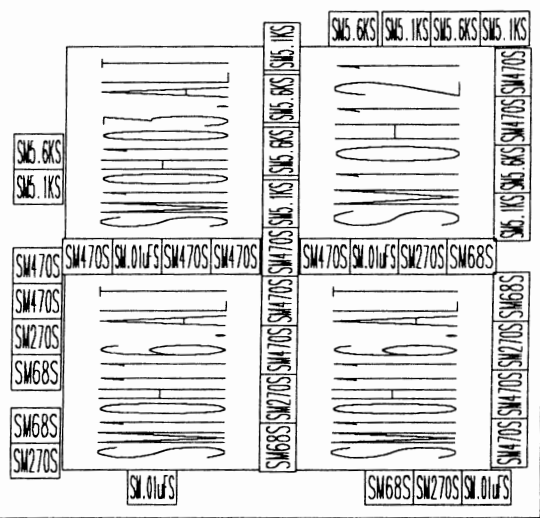

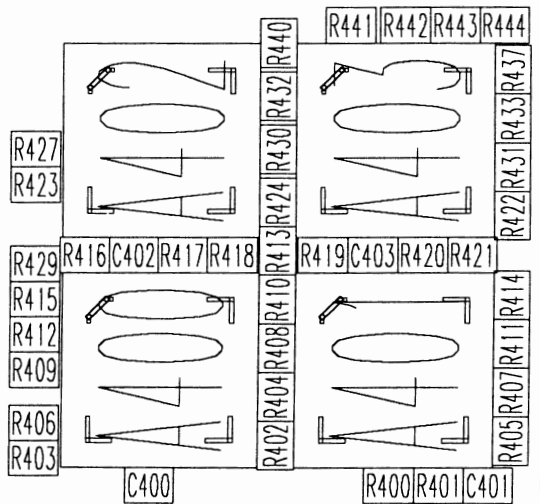
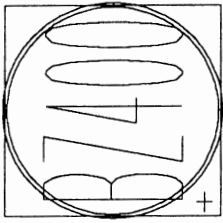

53004006

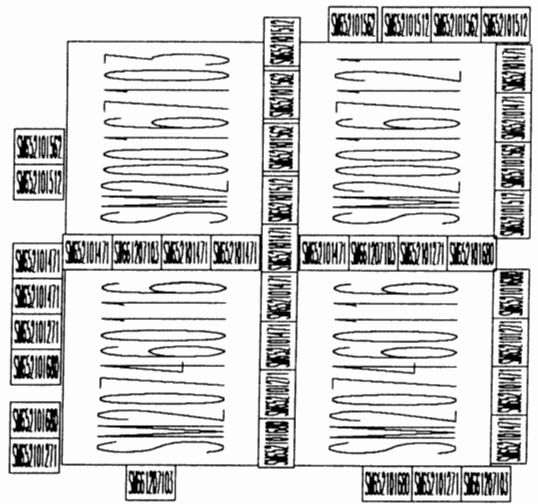

PART: F9314A-3 DESC: MAIN CARD (FRONT END, ADC, TDC) FOR 9314A/M/L

Location	Part Number	Description	Location	Part Number	Description
-----	-----	-----	-----	-----	-----
A1	SM200178138	SM74HCT138	A200	SM208580336	SMLM336-2.5
A2	SM200178138	SM74HCT138	A201	SM207878245	SM74HCT245
A3	SM206260858	SMADC0858	A202	SM200179373	SM74BCT373
A4	SM200178138	SM74HCT138	A203	SM-PSRAM	SM-PSRAM
A5	SM207970351	SM74HC4351	A204	SM207878245	SM74HCT245
A6	SM205618165	SM74HCT165	A205	SM200248191	SM74HCT191
A7	SM207978251	SM74HCT251	A206	SM-PSRAM	SM-PSRAM
A8	SM200178030	SM74HCT30	A207	SM200248191	SM74HCT191
A9	205750000	C16L8L	A208	SM207178541	SM74HCT541
A10	205750000	C16R4L	A209	SM207480843	SM74BCT29843
A11	SM207878245	SM74HCT245	A210	SM206886623	SM74BCT623
A12	SM207878245	SM74HCT245	A211	SM200248191	SM74HCT191
A14	SM207178541	SM74HCT541	A212	SM200248191	SM74HCT191
A16	205750000	C16L8L	A213	SM207878245	SM74HCT245
A17	SM207178541	SM74HCT541	A214	SM207480843	SM74BCT29843
A18	SM200278040	SM74HCT4040	A215	SM206886623	SM74BCT623
A19	SM207178541	SM74HCT541	A217	SM200248191	SM74HCT191
A20	SM200178139	SM74HCT139	A218	SM207878245	SM74HCT245
A21	205750000	C16L8L	A219	SM206886623	SM74BCT623
A22	MCL404	MCL404	A220	SM206886623	SM74BCT623
A23	205750000	C16R4L	A221	SM206886623	SM74BCT623
A24	SM207280703	SMDAC703	A222	SM207178541	SM74HCT541
A25	SM200178074	SM74HCT74	A223	SM200179373	SM74BCT373
A26	SM200178374	SM74HCT374	A224	MNX401	MNX401
A28	SM200178008	SM74HCT08	A225	SM206886623	SM74BCT623
A29	SM208570805	SM78L05	A226	208123002	7812-P
A50	SM200178000	SM74HCT00	A227	208122002	7805-P
A51	SM206070584	SMPCD8584	A228	208124003	7912-P
A52	SM205108002	EPROM 256B	A400	SM207460116	SM10H116
A100	208123002	7812-P	A401	SM207460116	SM10H116
A101	SM208470347	SMLF347	A402	SM200167103	SM10H103
A102	SM207770201	SMDG201-PS	A403	SM200167121	SM10H121
A103	SM208470347	SMLF347	A404	SM200167102	SM10H102
A104	208124003	7912-P	A405	SM200167105	SM10H105
A105	SM207770201	SMDG201-PS	A406	SM207460116	SM10H116
A106	SM208470347	SMLF347	A407	SM200167131	SM10H131
A107	SM208470705	SMAD705	A408	SM207460116	SM10H116
A108	208122002	7805-P	A409	SM200167105	SM10H105
A109	SM207770201	SMDG201-PS	A410	SM200167105	SM10H105
A110	SM207770442	SMDG442-PS	A411	SM200167105	SM10H105
A111	208124002	7905-P	A412	SM200267016	SM10H016
A115	SM208870339	SMLM339	A413	MST412	MST412
A116	208123002	7812-P	A414	SM200167131	SM10H131
A117	208124003	7912-P	A415	SM200167131	SM10H131

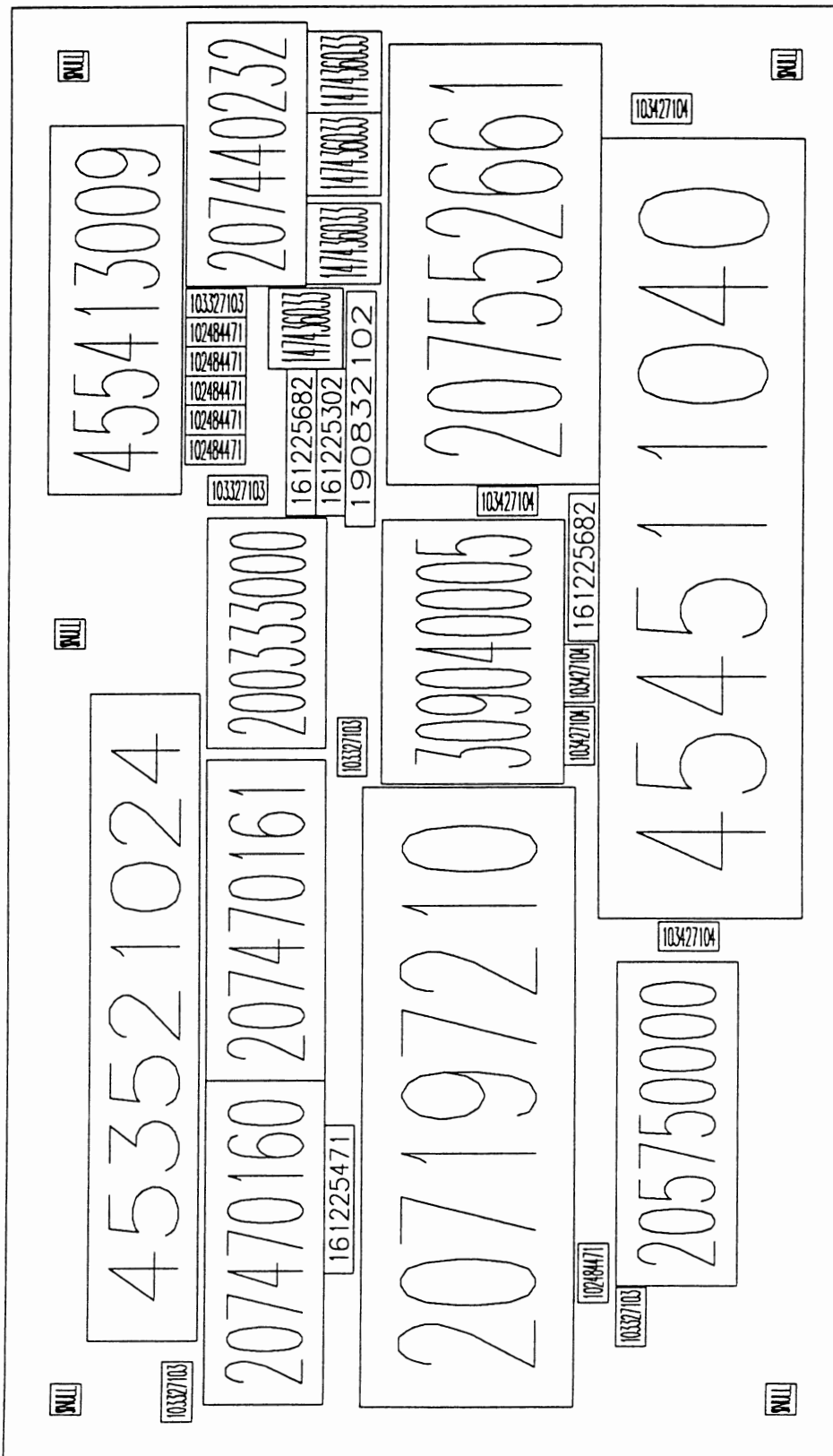

9300-4 REV:D

PART: F9300-4

DESC: GPIB + RS232 INTERFACE CARD

Location	Part Number	Description
-----	-----	-----
A1	207440232	MAX232
A2	200333000	74HCT00
A3	207470161	75161
A4	207470160	75160
A5	207552661	2661A
A6	207197210	7210
A7	205750000	C16R4L
C1	103327103	.01uF
C2	102484471	470pF
C3	102484471	470pF
C4	102484471	470pF
C5	102484471	470pF
C6	102484471	470pF
C7	103327103	.01uF
C8	103327103	.01uF
C9	147436033	33uF-16V-AL-RA
C10	147436033	33uF-16V-AL-RA
C11	147436033	33uF-16V-AL-RA
C12	147436033	33uF-16V-AL-RA
C13	103327103	.01uF
C14	103427104	.1uF
C15	103427104	.1uF
C16	103427104	.1uF
C17	102484471	470pF
C18	103427104	.1uF
C19	103327103	.01uF
C20	103427104	.1uF
J5	454511040	2x20-RA-M-RE
J6	455413009	DB9-RA-M-SC
J8	453521024	GPIB24-F-ME
R1	161225682	6.8K
R2	161225302	3K
R3	161225471	470
R5	161225682	6.8K
RN1	190832102	1K-8SS
Y1	309040005	K1100A-4.9152MHZ

PART: F9300-4**DESC: GPIB +RS232 INTERFACE CARD**

COMPONENT	PART DESCRIPTION	QTY PER ASSEMBLY
-----	-----	-----
102484471	CAP CERA DISC 100V 470 PF	6
103327103	CAP CERA MONO 50V .01 UF	5
103427104	CAP CERA MONO 100V .1 UF	5
147436033	CAP ALUM METAL CAN 33 UF	4
161225302	RES COMP 1/8W 5% 3 K	1
161225471	RES COMP 1/8W 5% 470 OHMS	1
161225682	RES CARBON FILM 6.8 K	2
190832102	RES NETWORK 1 K	1
200333000	IC QUAD 2-IN NAND HCT00	1
205750000	IC AND-OR GATE ARRAY 16V8	1
207197210	IC BUS INTERF CONTR 7210	1
207440232	IC XMTR/RCVR MAX 232	1
207470160	IC OCTAL BUS XCVR 75160A	1
207470161	IC OCTL BUS XCEIR 75161A	1
207552661	IC INTERFACE 2661A	1
309040005	CRYSTAL OSCIL. 4.9152MHZ	1
453521024	CONN RT ANGLE IEEE FEM 24	1
454511040	HDR SOLD TAIL/MALE/40/RT	1
455413009	CONN RT ANGLE MALE 9 S-CLIP	1
455980002	MOUNTING HDW FOR CONN SHELL	2
550130108	SCREW CYL HD M3X8	2
550430106	SCREW CYL HD PHIL M3X6	1
551430400	WASHER SHAKEPROOF M3	1
709300411	GPIB-RS232 INTERFACE BRACKET D	1
709300421	LABEL RS232-IEEE488-2 A	1
719300403	PC BD PREASS'Y 9300-4 D	1

Section 8 Schematics, Layouts, Parts list

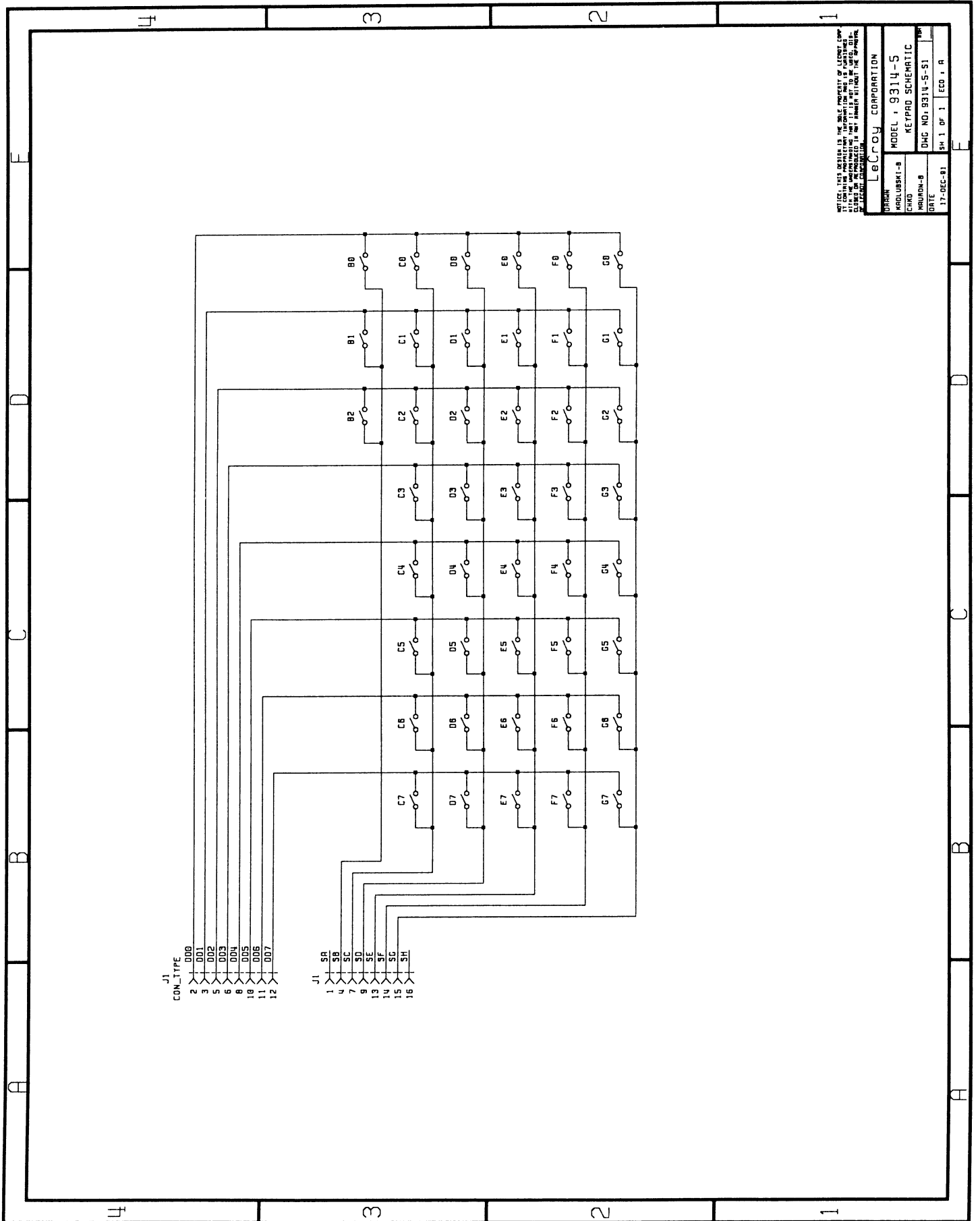

NOTICE: THIS DESIGN IS THE SOLE PROPERTY OF LECROY CORPORATION. ALL RIGHTS ARE RESERVED. THIS DESIGN IS NOT TO BE REPRODUCED OR TRANSMITTED IN ANY FORM OR BY ANY MEANS, ELECTRONIC OR MECHANICAL, INCLUDING PHOTOCOPYING, RECORDING, OR BY ANY INFORMATION STORAGE AND RETRIEVAL SYSTEM.

LECRUY CORPORATION	
MODEL : 9314-5	KEYPAD SCHEMATIC
DATE : 17-DEC-91	REV : 1 OF 1 ECD : A

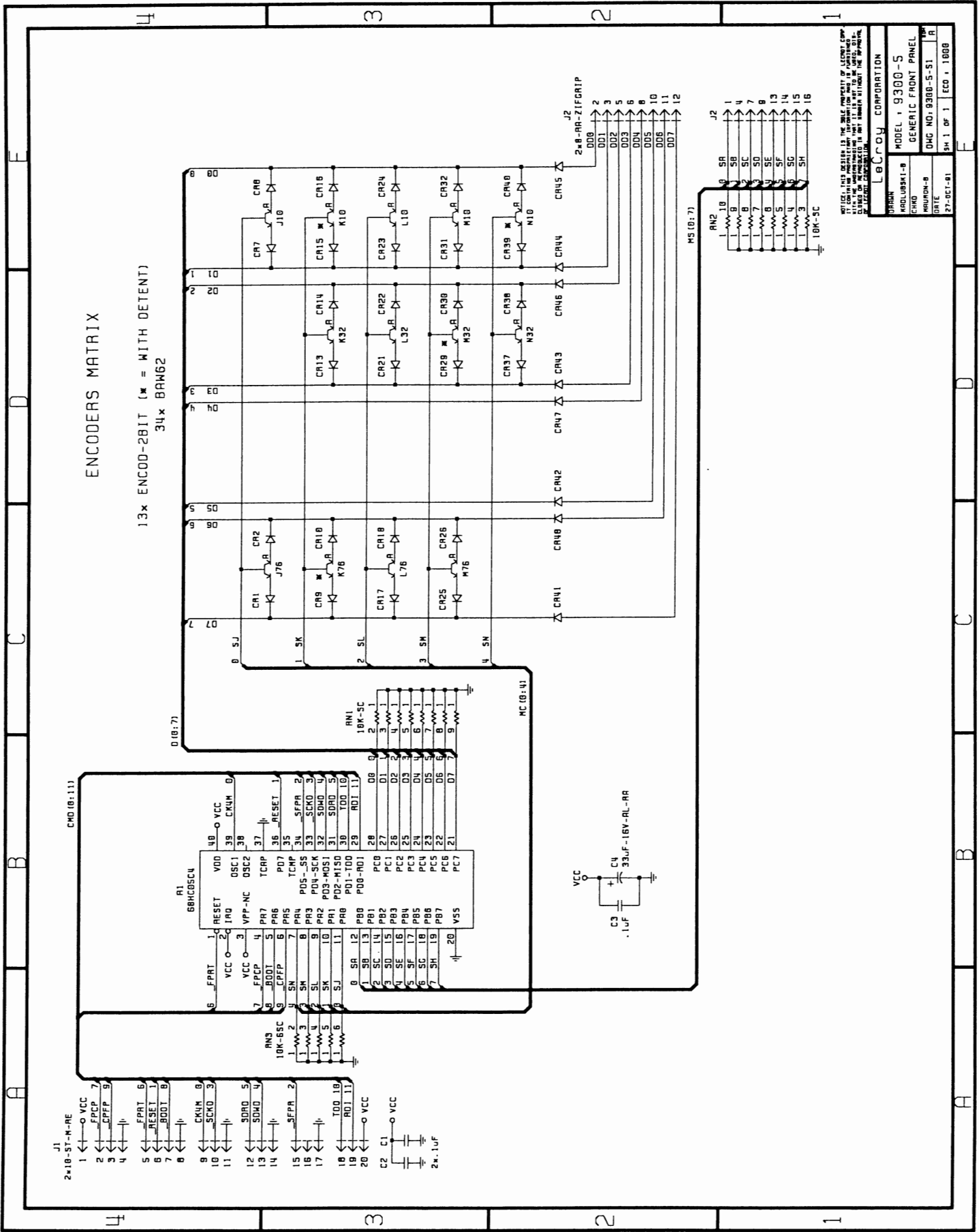

NOTICE: THIS DESIGN IS THE SOLE PROPERTY OF LEYBOLD COMPANY. IT CONTAINS PROPRIETARY INFORMATION AND IS UNCLASSIFIED. IT IS TO BE CONTAINED IN THE DRAWING FILE NUMBER WITHIN THE COMPANY'S RECORDS.

DATE	27-OCT-81
DRW NO.	9300-5-51
GENERIC FRONT PANEL	
MODEL	9300-5
COMPANY	LEYBOLD CORPORATION

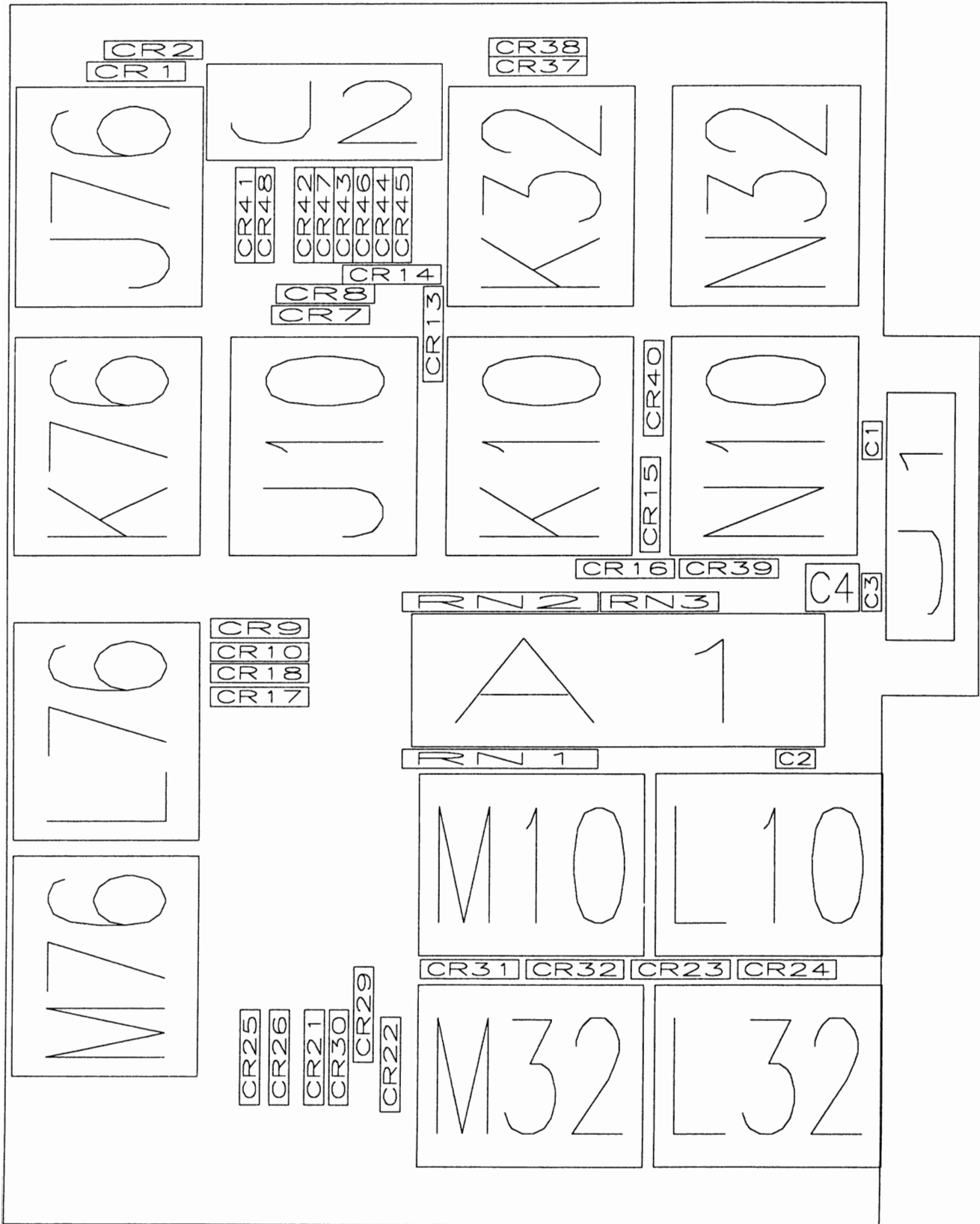

9300-5 PCB Rev:A

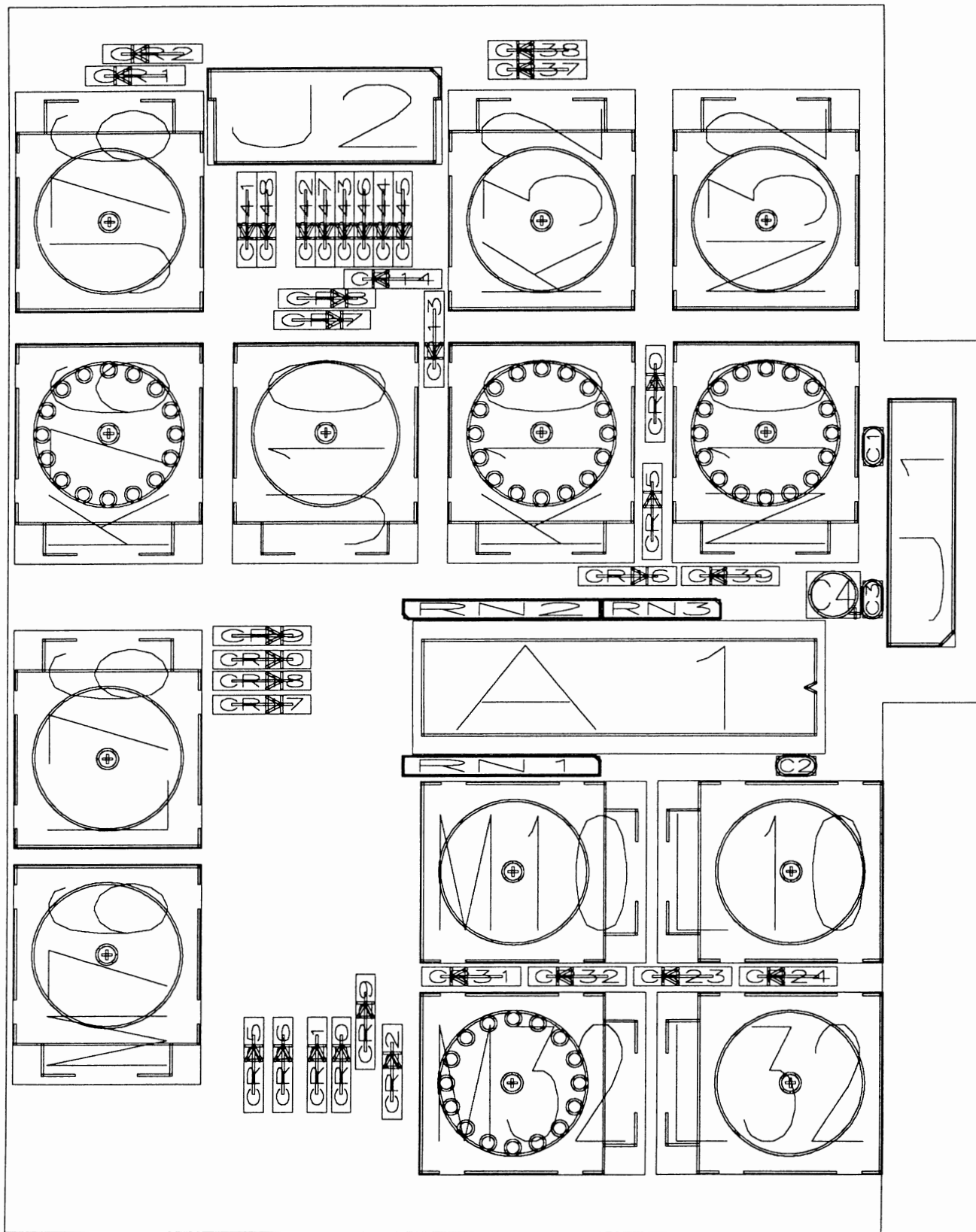

9300-5 PCB Rev: A

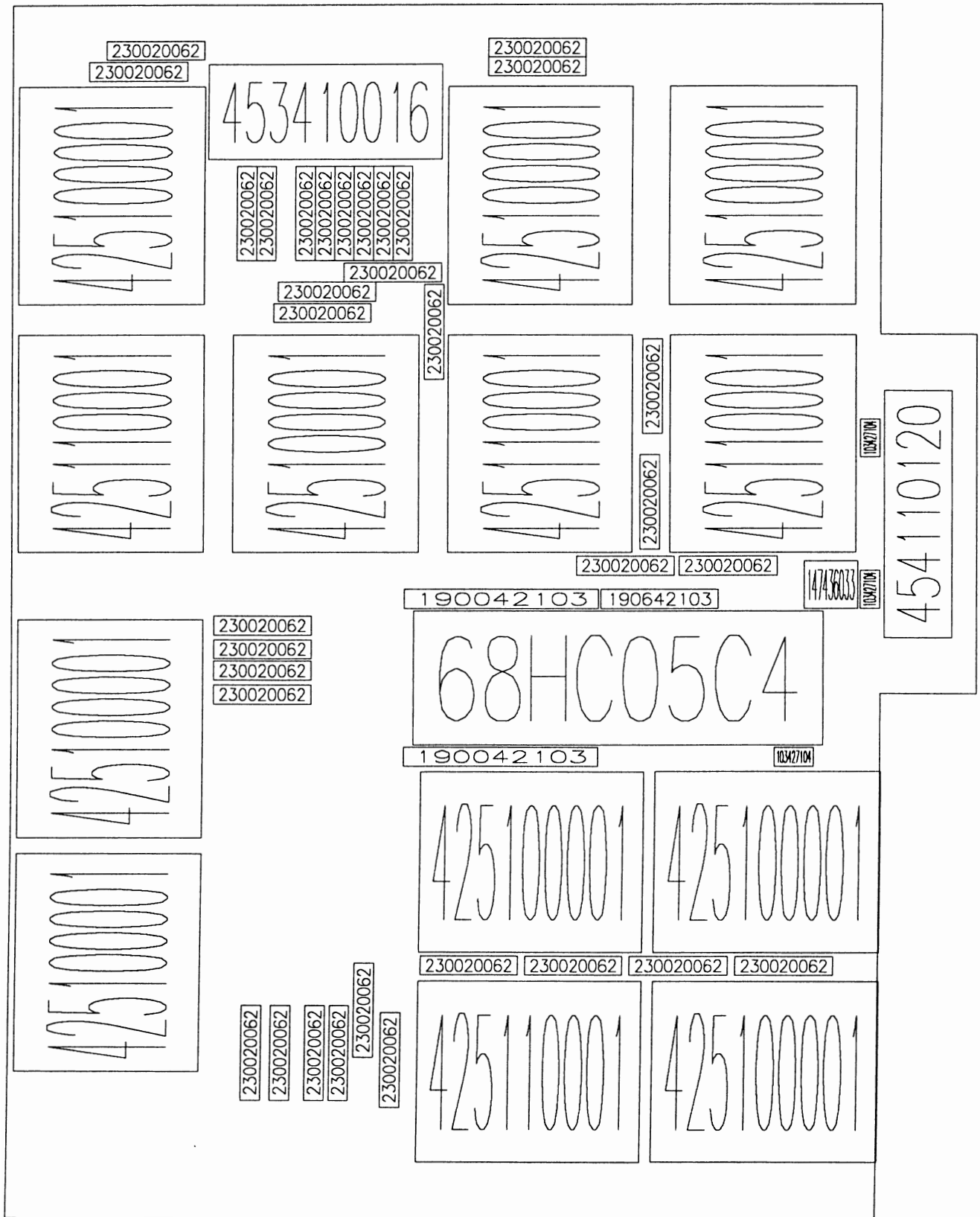

9300-5 PCB Rev:A

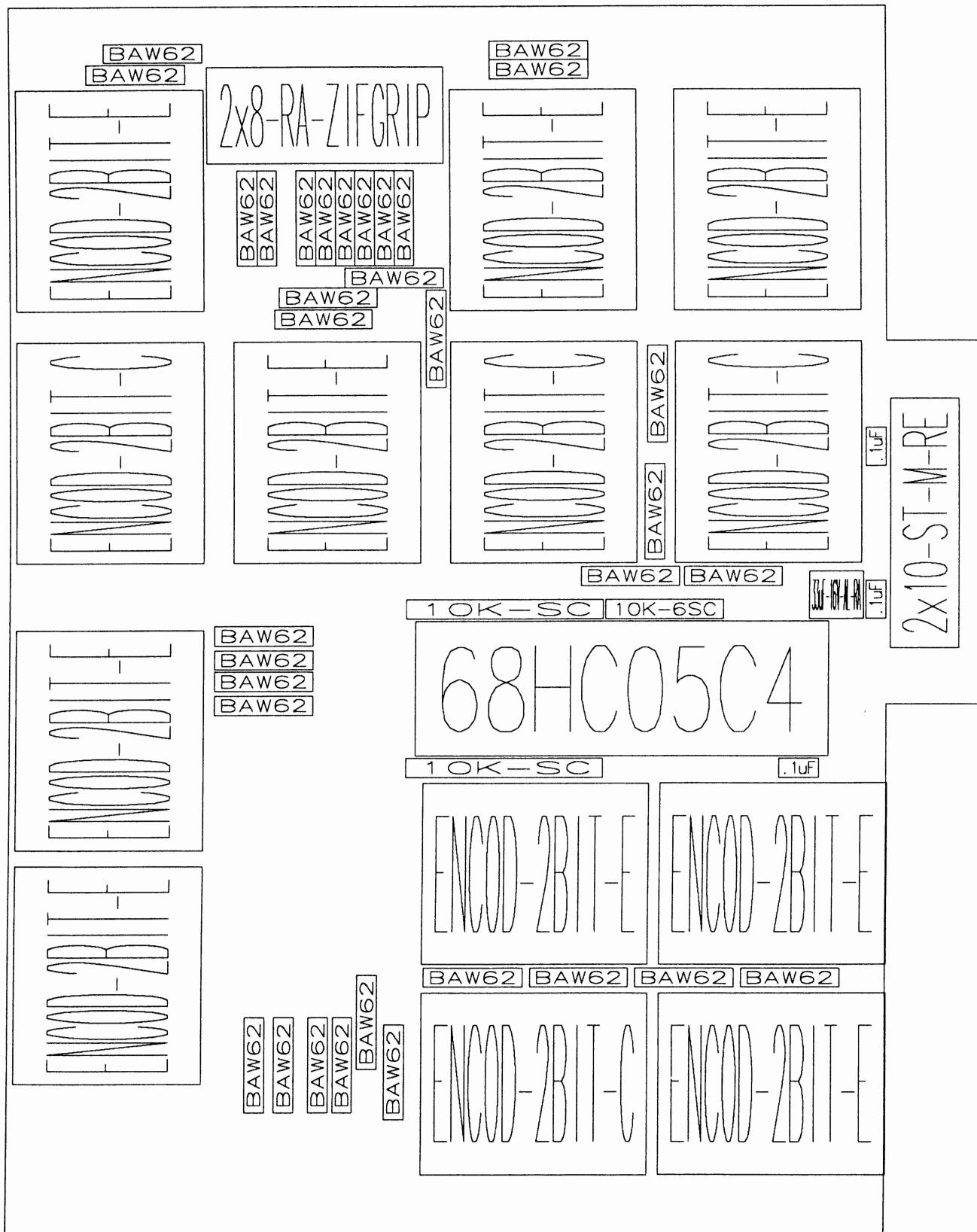

9300-5 PCB Rev : A

PART: F9354-5**DESC : Quad Channel Front Panel**

Location	Part Number	Description	Location	Part Number	Description
-----	-----	-----	-----	-----	-----
A1	68HC05C4	68HC05C4	CR15	230020062	BAW62
C1	103427104	.1uF	CR16	230020062	BAW62
C2	103427104	.1uF	CR17	230020062	BAW62
C3	103427104	.1uF	CR18	230020062	BAW62
C4	147436033	33uF-16V	CR21	230020062	BAW62
J1	454110120	2x10-ST-M-RE	CR22	230020062	BAW62
J2	453410016	2x8-RA-ZIFGRIP	CR23	230020062	BAW62
J3	453411016	2x8-ST-ZIF	CR24	230020062	BAW62
J10	425100001	ENCOD-2BIT-E	CR25	230020062	BAW62
J76	425100001	ENCOD-2BIT-E	CR26	230020062	BAW62
K10	425110001	ENCOD-2BIT-C	CR29	230020062	BAW62
K32	425100001	ENCOD-2BIT-E	CR30	230020062	BAW62
K76	425110001	ENCOD-2BIT-C	CR31	230020062	BAW62
L10	425100001	ENCOD-2BIT-E	CR32	230020062	BAW62
L32	425100001	ENCOD-2BIT-E	CR37	230020062	BAW62
L76	425100001	ENCOD-2BIT-E	CR38	230020062	BAW62
M10	425100001	ENCOD-2BIT-E	CR39	230020062	BAW62
M32	425110001	ENCOD-2BIT-C	CR40	230020062	BAW62
M76	425100001	ENCOD-2BIT-E	CR41	230020062	BAW62
N10	425110001	ENCOD-2BIT-C	CR42	230020062	BAW62
N32	425100001	ENCOD-2BIT-E	CR43	230020062	BAW62
CR1	230020062	BAW62	CR44	230020062	BAW62
CR2	230020062	BAW62	CR45	230020062	BAW62
CR7	230020062	BAW62	CR46	230020062	BAW62
CR8	230020062	BAW62	CR47	230020062	BAW62
CR9	230020062	BAW62	CR48	230020062	BAW62
CR10	230020062	BAW62	RN1	190042103	10K-SC
CR13	230020062	BAW62	RN2	190042103	10K-SC
CR14	230020062	BAW62	RN3	190642103	10K-6SC

PART: F9354-5**DESC : Quad Channel Front Panel**

COMPONENT	PART DESCRIPTION	QTY PER ASSEMBLY
-----	-----	-----
103427104	CAP CERA MONO 100V .1 UF	3
147436033	CAP ALUM METAL CAN 33 UF	1
190042103	RESISTOR NETWORK 10 K	2
190642103	RESISTOR NETWORK 10 K	1
230020062	DIODE SWITCHING BAW62	34
425100001	ENCODER DIGITAL 24 POS	8
425110001	ENCODER DIGITAL 24 POS	3
453410016	CONN FLEX CIRCUIT 16-POS	1
454110120	HDR SLD TAIL/MALE/20/STRAIGHT	1
554435004	SCREW PT PHIL KA35X10	1
7093XX511	KNOB 10MM DIAMETRE	7
7093XX521	KNOB 14MM DIAMETRE	4
719300503	PC BD PREASS'Y 9300-5	1
729354513	FP KEYBOARD ASS'Y 9354-5	1
MFP414	IC FRT PANEL PROCESSOR MFP414	1

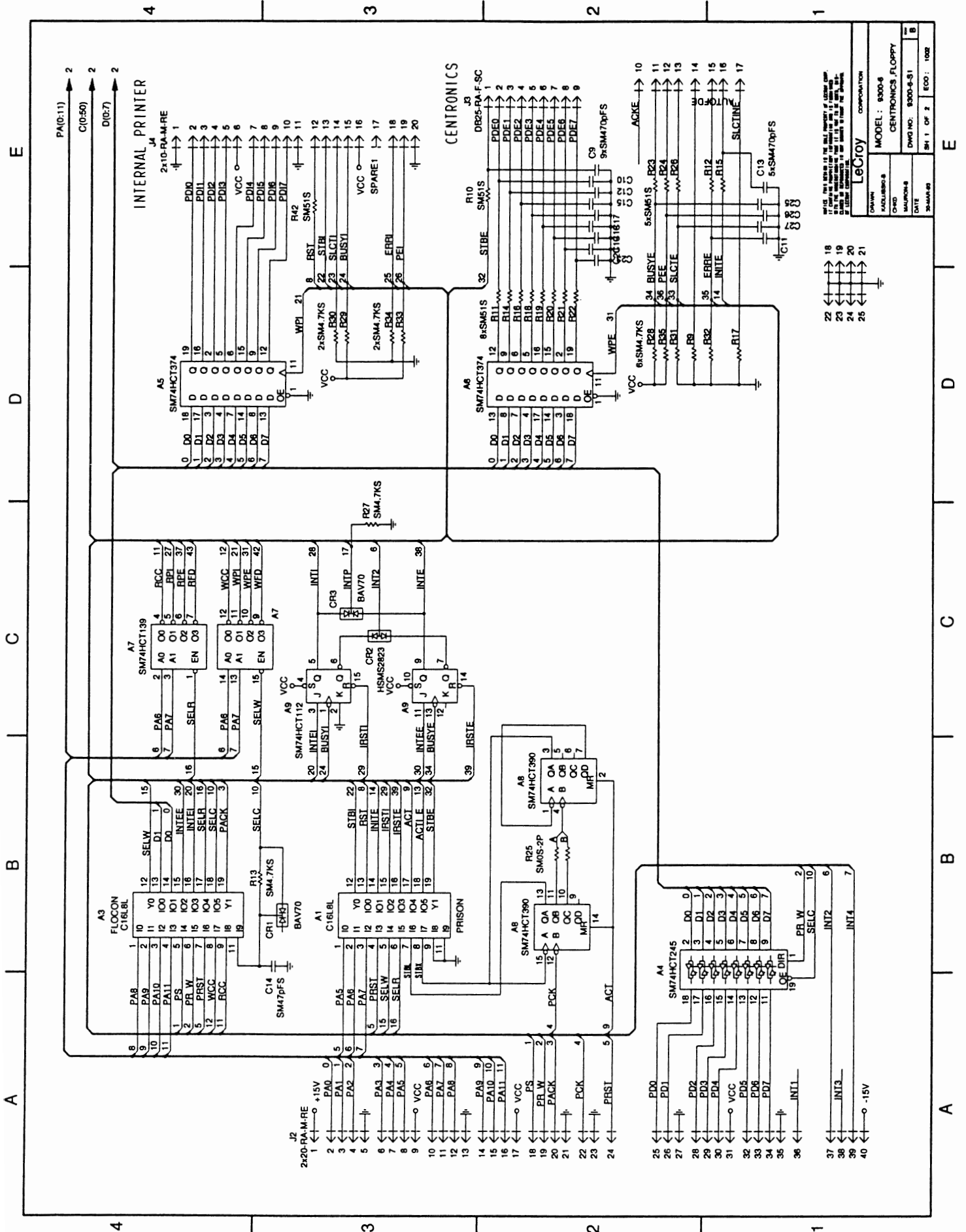

DATE	30-MAR-87
DESIGNER	SA-MAR-87
APPROVED	
MODEL	8300-4
COMPANION	
CENTRONICS FLOPPY	
DATE	8300-4-31
SH 1 OF 2	ECO: 100Z

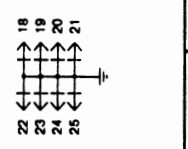

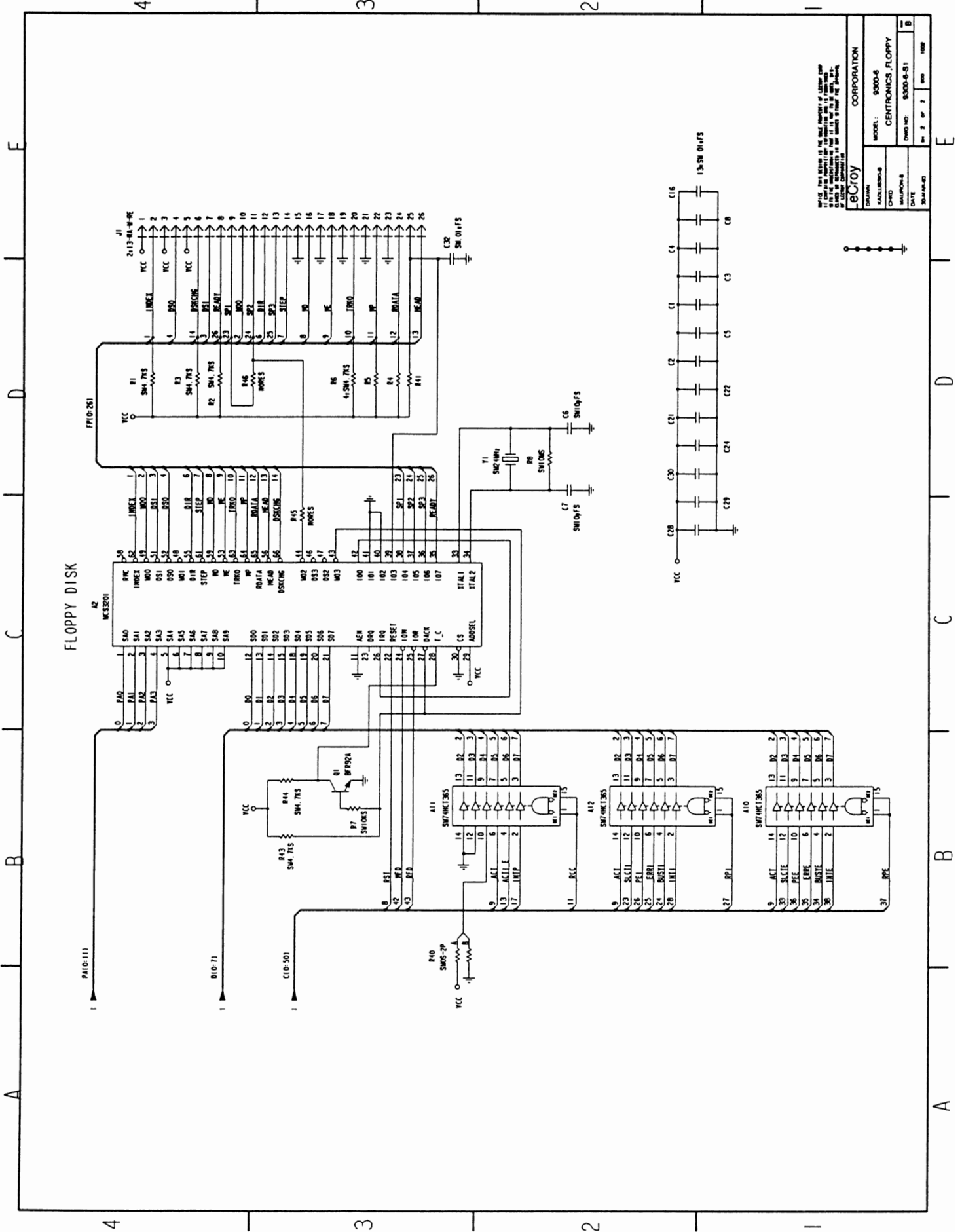

LEClroy CORPORATION
 MODEL: 9300-6
 CENTRONICS FLOPPY
 PART NO: 9300-6-S1

9300-6 Rev: C

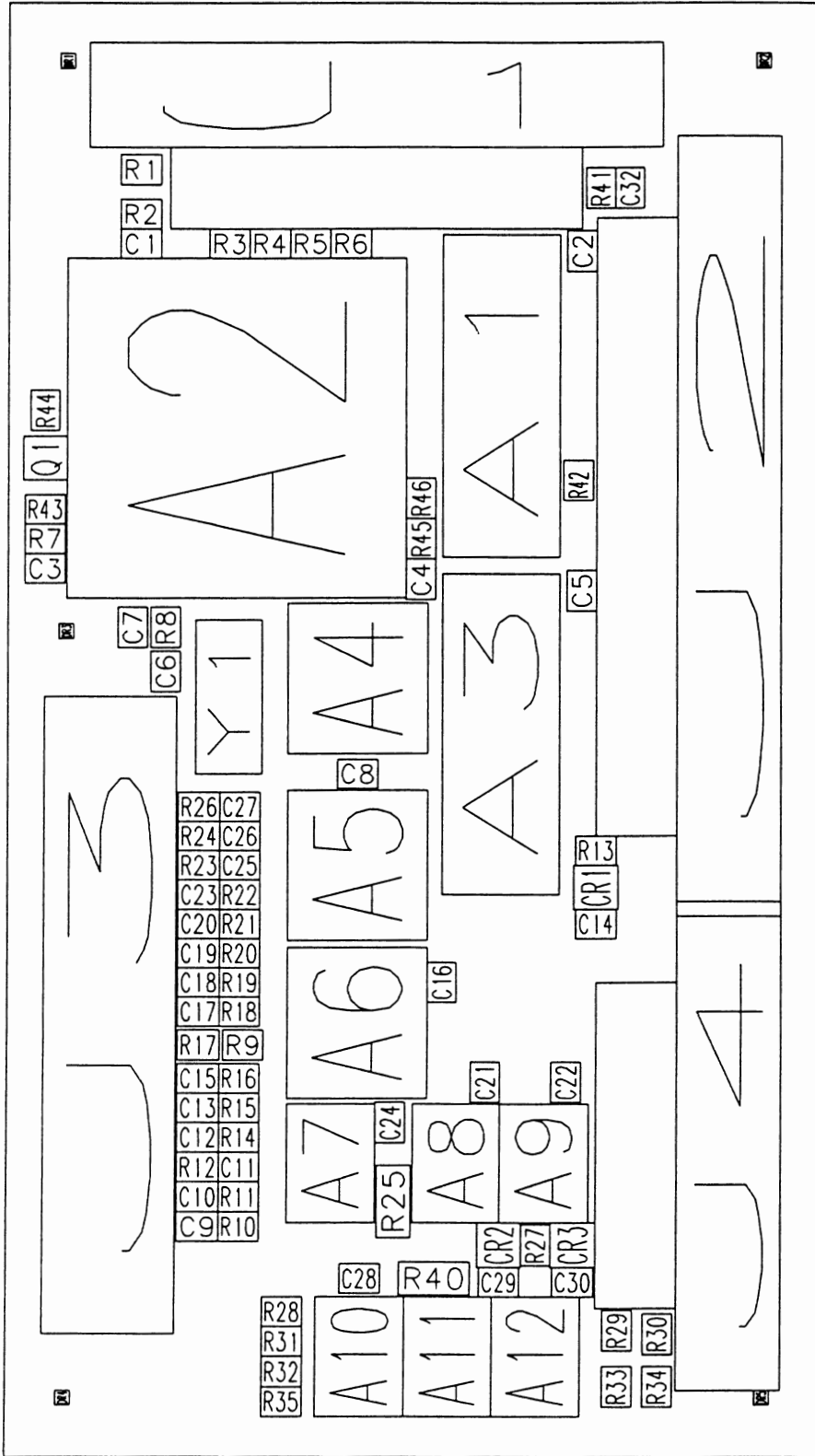

9300-6 Rev : C

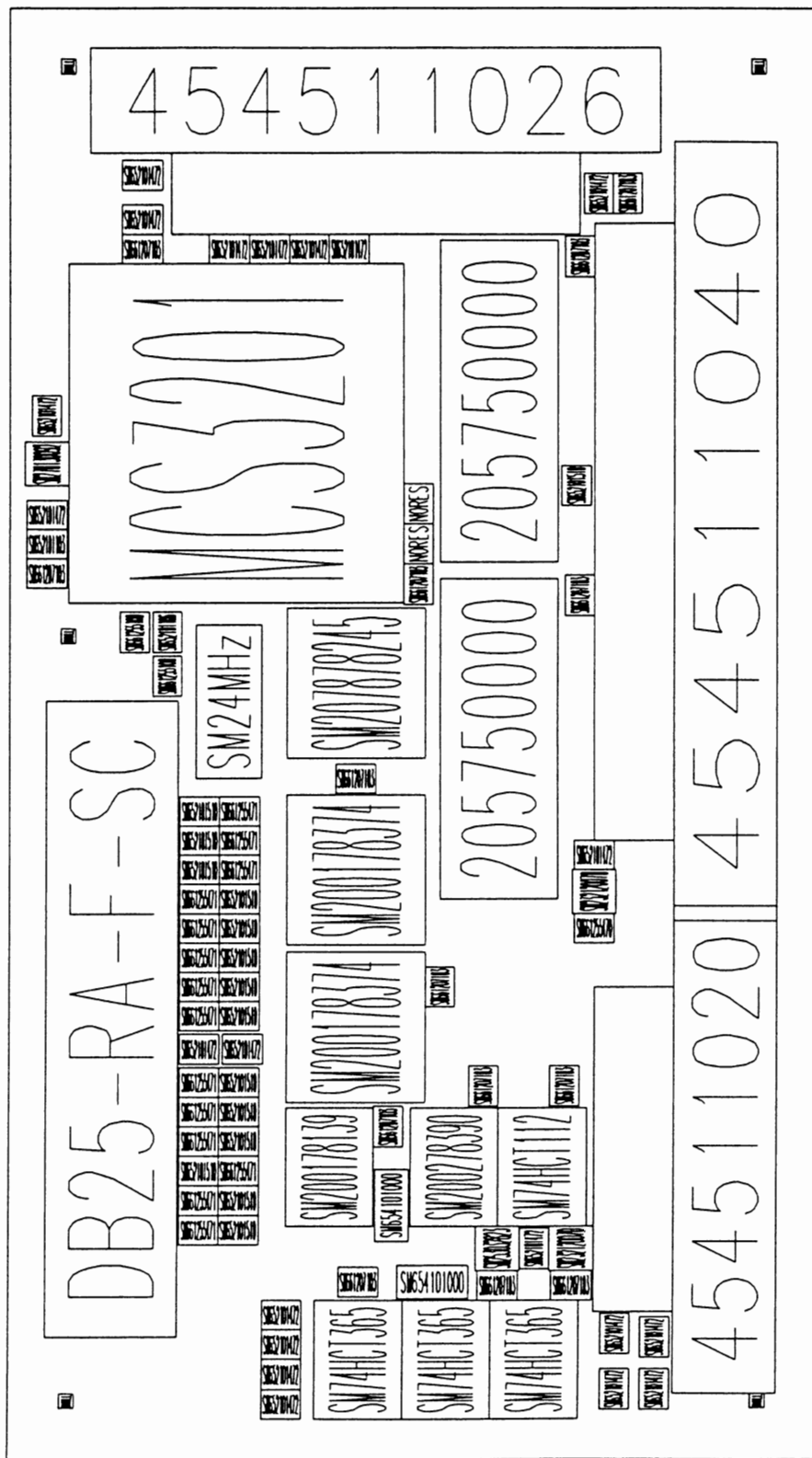

9300-6 Rev:C

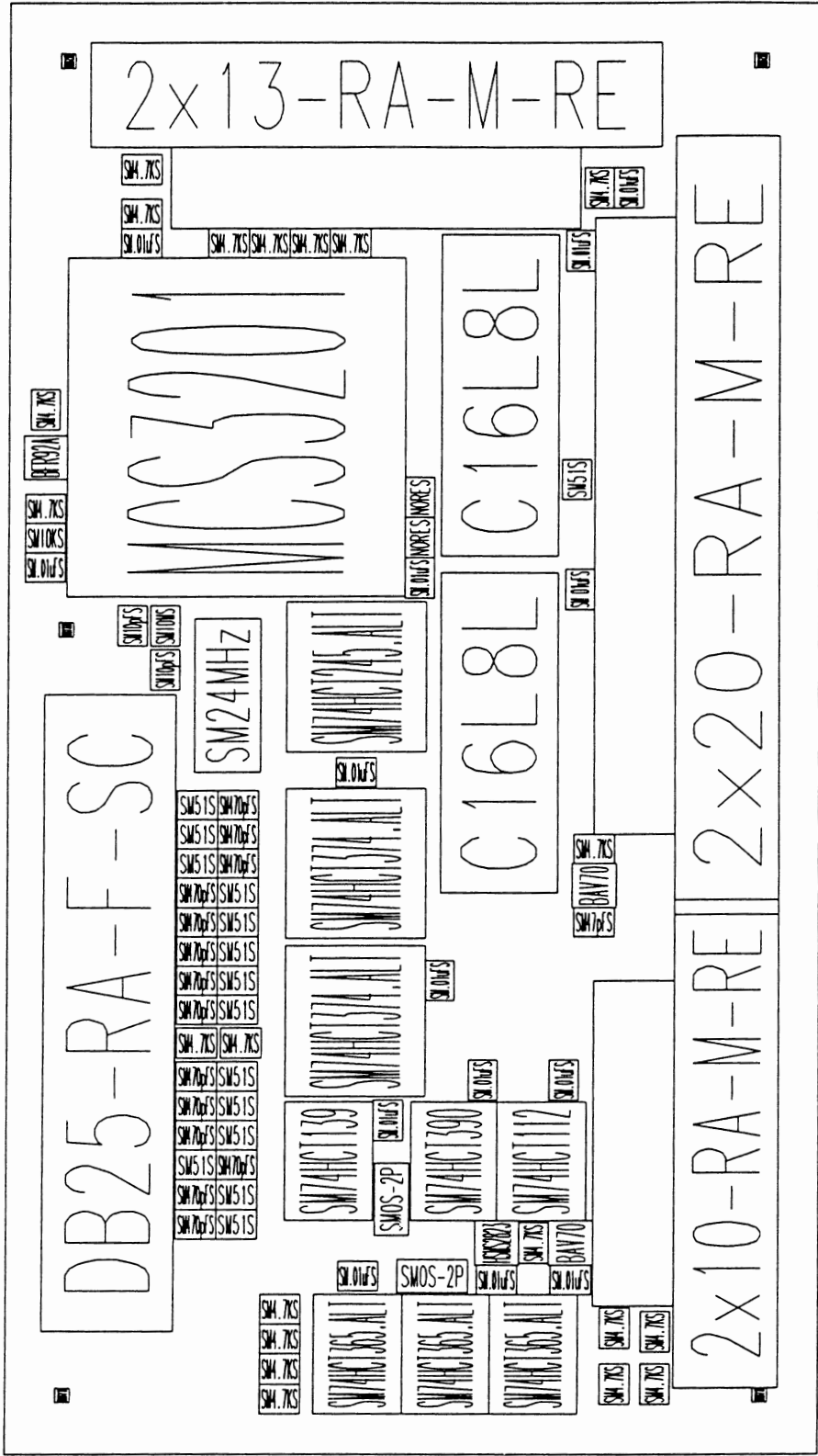

PART: F9300-6**DESC: CENTRONICS, FLOPPY AND PRINTER INTERFACE**

Location	Part Number	Description	Location	Part Number	Description
-----	-----	-----	-----	-----	-----
A1	205750000	C16L8L	CR2	SM253032823	HSMS2823
A2	SM227063201	MCS3201	CR3	SM232120070	BAV70
A3	205750000	C16L8L	J1	454511026	2x13-RA-M-RE
A4	SM207878245	SM74HCT245	J2	454511040	2x20-RA-M-RE
A5	SM200178374	SM74HCT374	J3	454520025	DB25-RA-F-SC
A6	SM200178374	SM74HCT374	J4	454511020	2x10-RA-M-RE
A7	SM200178139	SM74HCT139	Q1	SM270130092	BFR92A
A8	SM200278390	SM74HCT390	R1	SM652101472	SM4.7KS
A9	SM201170112	SM74HCT112	R2	SM652101472	SM4.7KS
A10	SM207170036	SM74HCT365	R3	SM652101472	SM4.7KS
A11	SM207170036	SM74HCT365	R4	SM652101472	SM4.7KS
A12	SM207170036	SM74HCT365	R5	SM652101472	SM4.7KS
C1	SM661207103	SM.01uF	R6	SM652101472	SM4.7KS
C2	SM661207103	SM.01uF	R7	SM652101103	SM10KS
C3	SM661207103	SM.01uF	R8	SM652101106	SM10MS
C4	SM661207103	SM.01uF	R9	SM652101472	SM4.7KS
C5	SM661207103	SM.01uF	R10	SM652101510	SM51S
C6	SM661255100	SM10pF	R11	SM652101510	SM51S
C7	SM661255100	SM10pF	R12	SM652101510	SM51S
C8	SM661207103	SM.01uF	R13	SM652101472	SM4.7KS
C9	SM661255471	SM470pF	R14	SM652101510	SM51S
C10	SM661255471	SM470pF	R15	SM652101510	SM51S
C11	SM661255471	SM470pF	R16	SM652101510	SM51S
C12	SM661255471	SM470pF	R17	SM652101472	SM4.7KS
C13	SM661255471	SM470pF	R18	SM652101510	SM51S
C14	SM661255470	SM47pF	R19	SM652101510	SM51S
C15	SM661255471	SM470pF	R20	SM652101510	SM51S
C16	SM661207103	SM.01uF	R21	SM652101510	SM51S
C17	SM661255471	SM470pF	R22	SM652101510	SM51S
C18	SM661255471	SM470pF	R23	SM652101510	SM51S
C19	SM661255471	SM470pF	R24	SM652101510	SM51S
C20	SM661255471	SM470pF	R25	SM654101000	SM0S-2P
C21	SM661207103	SM.01uF	R26	SM652101510	SM51S
C22	SM661207103	SM.01uF	R27	SM652101472	SM4.7KS
C23	SM661255471	SM470pF	R28	SM652101472	SM4.7KS
C24	SM661207103	SM.01uF	R29	SM652101472	SM4.7KS
C25	SM661255471	SM470pF	R30	SM652101472	SM4.7KS
C26	SM661255471	SM470pF	R31	SM652101472	SM4.7KS
C27	SM661255471	SM470pF	R32	SM652101472	SM4.7KS
C28	SM661207103	SM.01uF	R33	SM652101472	SM4.7KS
C29	SM661207103	SM.01uF	R34	SM652101472	SM4.7KS
C30	SM661207103	SM.01uF	R35	SM652101472	SM4.7KS
C32	SM661207103	SM.01uF	R40	SM654101000	SM0S-2P
CR1	SM232120070	BAV70	R41	SM652101472	SM4.7KS

PART: F9300-6 DESC: CENTRONICS/FLOPPY/PRINTER INTERFACE

Location -----	Part Number -----	Description -----
R42	SM652101510	SM51S
R43	SM652101472	SM4.7KS
R44	SM652101472	SM4.7KS
Y1	SM310900024	SM24MHz

PART: F9300-6 DESC: CENTRONICS/FLOPPY/PRINTER INTERFACE

Component -----	Part Description -----	Qty Per Assembly -----
205750000	IC AND-OR GATE ARRAY 16V8	2
454511020	HDR SOLD TAIL/MALE 20	1
454511026	HDR SOLD TAIL/MALE 26	1
454511040	HDR SOLD TAIL/MALE/40/RT	1
454520025	CONN RT ANGLE FEM 25 S-CLIP	1
455980002	MOUNTING HDW FOR CONN SHELL	2
550430106	SCREW CYL HD PHIL M3X6	4
551430400	WASHER SHAKEPROOF M3	4
709300611	CENTR. FLOPPY INTERF. BRACKET B	1
709300621	LABEL PARA-INTERF. CENTRONICS A	1
719300603	PC BD PREASS'Y 9300-6 C	1
SM200178139	IC 2-TO-4-LINE DEC HCT139	1
SM200178374	IC D-TYP FLOP 74HCT374	2
SM200278390	IC 4-BIT RIPPLE COUNTER	1
SM201170112	IC DUAL JK FF WITH SET-RESET	1
SM207170036	IC HEX BUFFER 3-STATE	3
SM207878245	IC BUS TRANSCVR HCT 245	1
SM227063201	IC IBM PC FLOPPY DISK CONTR.	1
SM232120070	DIODE ARRAY BAV70	1
SM253032823	DIODE SCHOTTKY 2823	1
SM270130092	TRANSISTOR NPN BFR92A	1
SM310900024	CRYSTAL 24 MHZ SMD	1
SM652101103	RES CHIP (E24) 1% 10 K	1
SM652101106	RES CHIP (E24) 1% 10 MEG	1
SM652101472	RES CHIP (E24) 1% 4.7 K	21
SM652101510	RES CHIP (E24) 1% 51 OHMS	15
SM654101000	CHIP JUMPER ZERO OHMS	2
SM661207103	CAP CERA CHIP 20% .01UF	14
SM661255100	CAP CERA CHIP 10PF	2
SM661255470	CAP CERA CHIP 47PF	1
SM661255471	CAP CERA CHIP 5% 470 PF	14

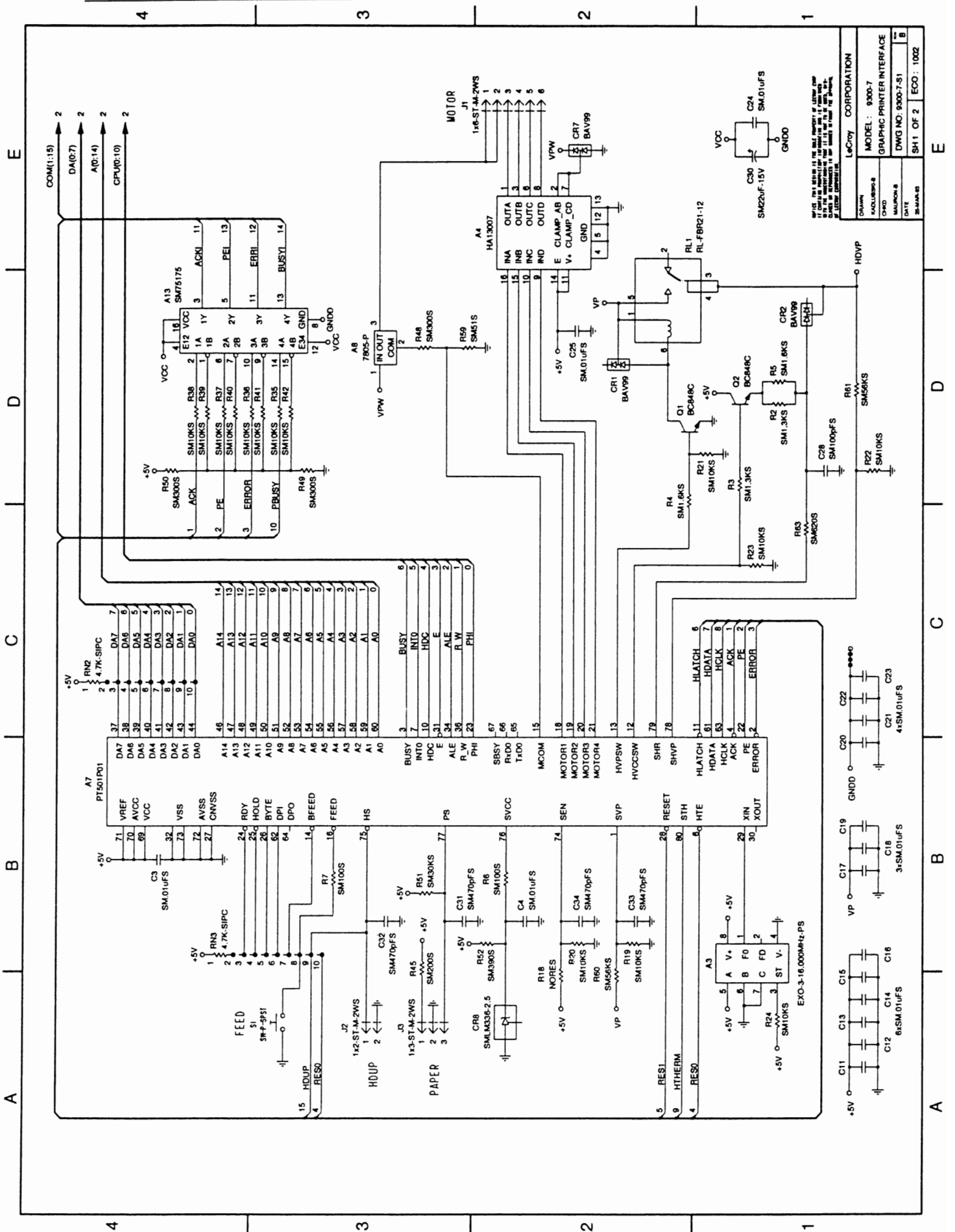

Section 8 Schematics, Layouts, Parts list

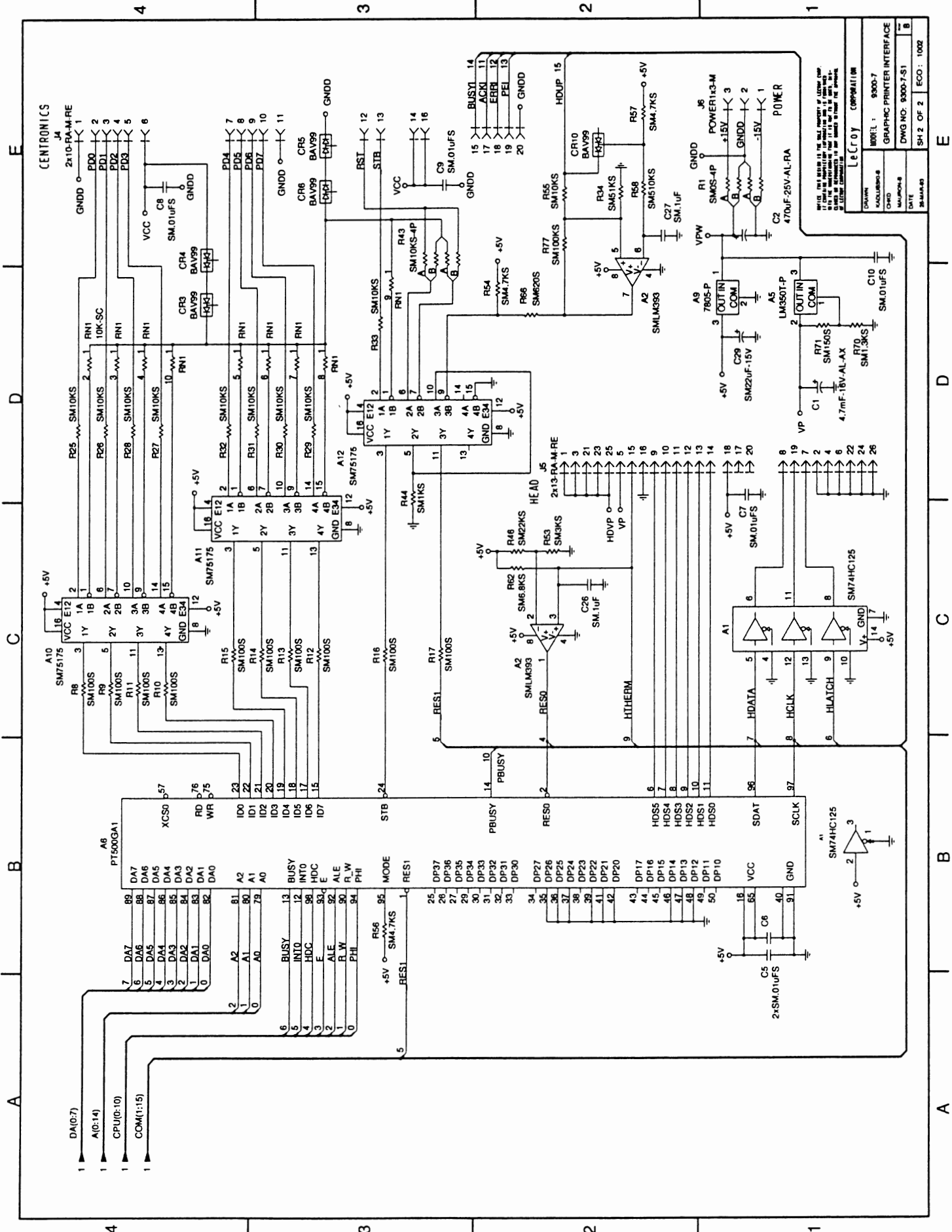

NOTE: THIS DRAWING IS THE SOLE PROPERTY OF LEXCOM CORP. IT IS TO BE USED ONLY FOR THE PROJECT AND PARTS LISTED HEREIN. IT IS NOT TO BE REPRODUCED OR TRANSMITTED IN ANY FORM OR BY ANY MEANS, ELECTRONIC OR MECHANICAL, INCLUDING PHOTOCOPYING, RECORDING, OR BY ANY INFORMATION STORAGE AND RETRIEVAL SYSTEM, WITHOUT THE WRITTEN PERMISSION OF LEXCOM CORP.

DESIGN	MODEL	9300-7
QUANTITY	GRAPHIC PRINTER INTERFACE	
ORD	DWG NO.	9300-7-S1
DATE	DATE	
BY	SH 2 OF 2	ECO : 1002

9300-7 Rev:C

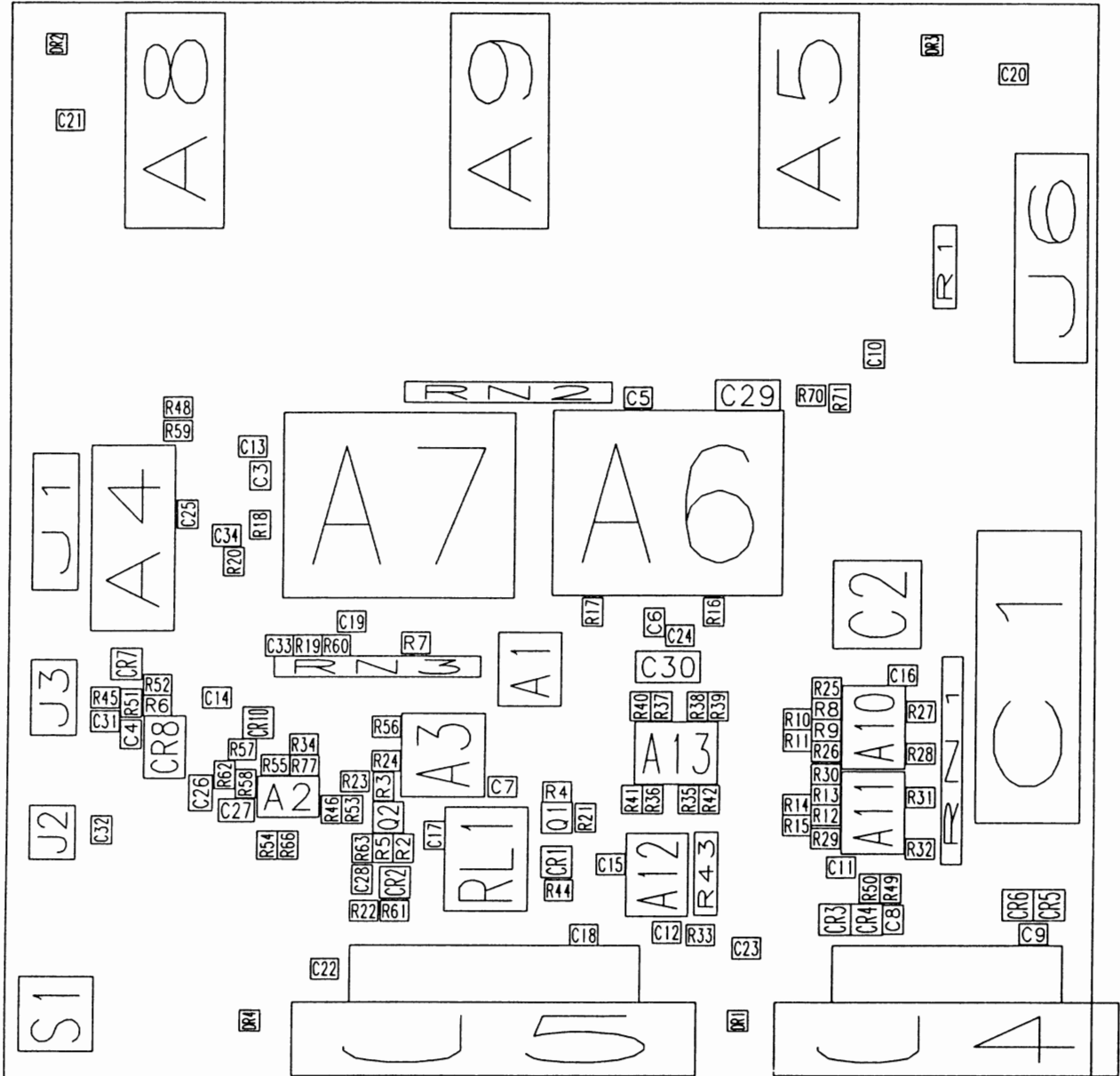

9300-7 Rev:C

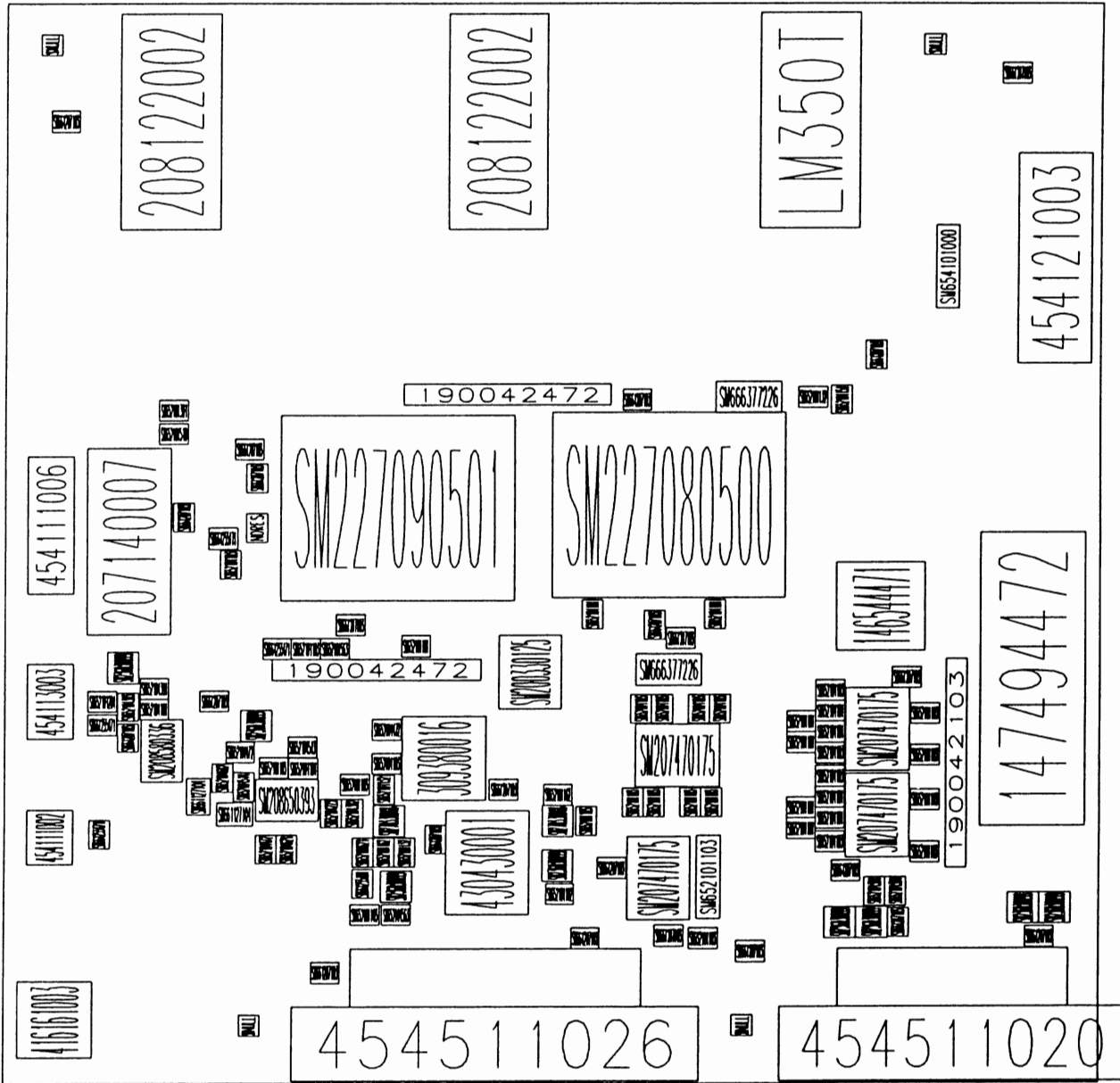

9300-7 Rev:C

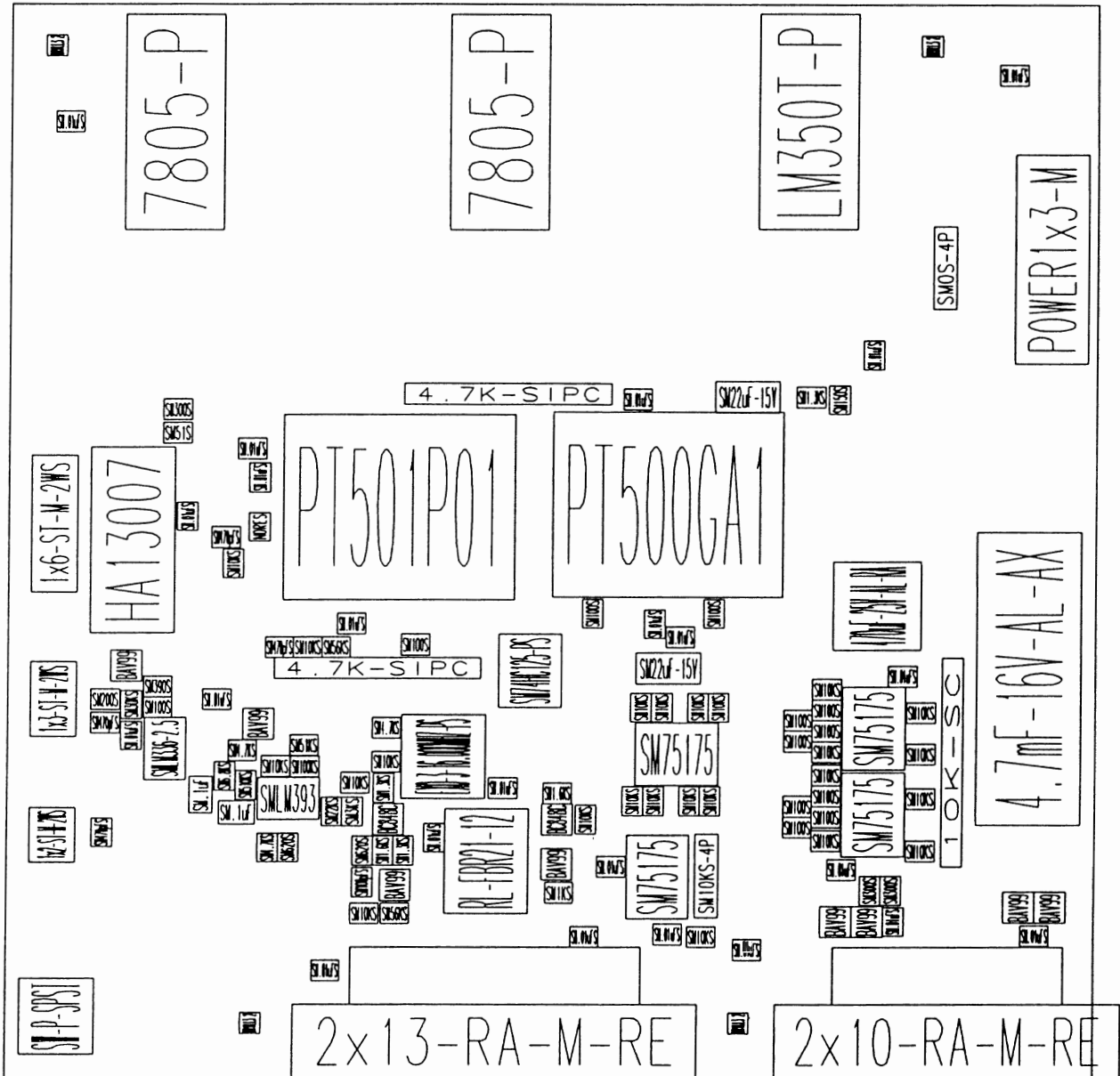

PART: F9300-7

DESC: LTP 5446 PRINTER CONTROLLER

Location	Part Number	Description	Location	Part Number	Description
-----	-----	-----	-----	-----	-----
A1	SM200330125	SM74HC125	C32	SM661255471	SM470pF
A2	SM208650393	SMLM393	C33	SM661255471	SM470pF
A3	309380016	16.000MHZ	C34	SM661255471	SM470pF
A4	207140007	HA13007	CR1	SM236030099	BAV99
A5	208590350	LM350T-P	CR2	SM236030099	BAV99
A6	SM227080500	PT500GA1	CR3	SM236030099	BAV99
A7	SM227090501	PT501P01	CR4	SM236030099	BAV99
A8	208122002	7805-P	CR5	SM236030099	BAV99
A9	208122002	7805-P	CR6	SM236030099	BAV99
A10	SM207470175	SM75175	CR7	SM236030099	BAV99
A11	SM207470175	SM75175	CR8	SM208580336	SMLM336-2.5
A12	SM207470175	SM75175	CR10	SM236030099	BAV99
A13	SM207470175	SM75175	J1	454111006	1x6-ST-M-2WS
C1	147494472	4.7mF-16V	J2	454111002	1x2-ST-M-2WS
C2	146544471	470uF-25V	J3	454113003	1x3-ST-M-2WS
C3	SM661207103	SM.01uF	J4	454511020	2x10-RA-M-RE
C4	SM661207103	SM.01uF	J5	454511026	2x13-RA-M-RE
C5	SM661207103	SM.01uF	J6	454121003	POWER1x3-M
C6	SM661207103	SM.01uF	Q1	SM270330848	BC848C
C7	SM661207103	SM.01uF	Q2	SM270330848	BC848C
C8	SM661207103	SM.01uF	R1	SM654101000	SM0S-4P
C9	SM661207103	SM.01uF	R2	SM652101132	SM1.3KS
C10	SM661207103	SM.01uF	R3	SM652101132	SM1.3KS
C11	SM661207103	SM.01uF	R4	SM652101162	SM1.6KS
C12	SM661207103	SM.01uF	R5	SM652101162	SM1.6KS
C13	SM661207103	SM.01uF	R6	SM652101101	SM100S
C14	SM661207103	SM.01uF	R7	SM652101101	SM100S
C15	SM661207103	SM.01uF	R8	SM652101101	SM100S
C16	SM661207103	SM.01uF	R9	SM652101101	SM100S
C17	SM661207103	SM.01uF	R10	SM652101101	SM100S
C18	SM661207103	SM.01uF	R11	SM652101101	SM100S
C19	SM661207103	SM.01uF	R12	SM652101101	SM100S
C20	SM661207103	SM.01uF	R13	SM652101101	SM100S
C21	SM661207103	SM.01uF	R14	SM652101101	SM100S
C22	SM661207103	SM.01uF	R15	SM652101101	SM100S
C23	SM661207103	SM.01uF	R16	SM652101101	SM100S
C24	SM661207103	SM.01uF	R17	SM652101101	SM100S
C25	SM661207103	SM.01uF	R19	SM652101103	SM10KS
C26	SM661127104	SM.1uF	R20	SM652101103	SM10KS
C27	SM661127104	SM.1uF	R21	SM652101103	SM10KS
C28	SM661255101	SM100pF	R22	SM652101103	SM10KS
C29	SM666377226	SM22uF-15V	R23	SM652101103	SM10KS
C30	SM666377226	SM22uF-15V	R24	SM652101103	SM10KS
C31	SM661255471	SM470pF	R25	SM652101103	SM10KS

PART: F9300-7**DESC: LTP 5446 PRINTER CONTROLLER**

Location	Part Number	Description	Location	Part Number	Description
-----	-----	-----	-----	-----	-----
R26	SM652101103	SM10KS	R50	SM652101301	SM300S
R27	SM652101103	SM10KS	R51	SM652101303	SM30KS
R28	SM652101103	SM10KS	R52	SM652101391	SM390S
R29	SM652101103	SM10KS	R53	SM652101302	SM3KS
R30	SM652101103	SM10KS	R54	SM652101472	SM4.7KS
R31	SM652101103	SM10KS	R55	SM652101103	SM10KS
R32	SM652101103	SM10KS	R56	SM652101472	SM4.7KS
R33	SM652101103	SM10KS	R57	SM652101472	SM4.7KS
R34	SM652101513	SM51KS	R58	SM652101514	SM510KS
R35	SM652101103	SM10KS	R59	SM652101510	SM51S
R36	SM652101103	SM10KS	R60	SM652101563	SM56KS
R37	SM652101103	SM10KS	R61	SM652101563	SM56KS
R38	SM652101103	SM10KS	R62	SM652101682	SM6.8KS
R39	SM652101103	SM10KS	R63	SM652101621	SM620S
R40	SM652101103	SM10KS	R66	SM652101621	SM620S
R41	SM652101103	SM10KS	R70	SM652101132	SM1.3KS
R42	SM652101103	SM10KS	R71	SM652101151	SM150S
R43	SM652101103	SM10KS-4P	R77	SM652101104	SM100KS
R44	SM652101102	SM1KS	RL1	430430001	RL-FBR21-12
R45	SM652101201	SM200S	RN1	190042103	10K-SC
R46	SM652101223	SM22KS	RN2	190042472	4.7K-SIPC
R48	SM652101301	SM300S	RN3	190042472	4.7K-SIPC
R49	SM652101301	SM300S	S1	416161003	SW-P-SPST

PART: F9300-7**DESC: LTP 5446 PRINTER CONTROLLER**

Component	Part Description	Qty Per Assembly
-----	-----	-----
146544471	CAP MINI ALUM 20% 470UF	1
147494472	CAP ALU COMPACT AXIAL 4700 UF	1
190042103	RESISTOR NETWORK 10 K	1
190042472	RESISTOR NETWORK 4.7 K	2
207140007	IC QUAD STEP MOTOR DRIVER	1
208122002	IC VOLT REG POS UA7805	2
208590350	IC ADJ POWER REG 3A LM350	1
309380016	CRYSTAL OSC (PROGR) 16 MHZ	1
416161003	SWITCH PUSHBUTTON SPST	1
430430002	RELAY 1 FORM C SPDT	1
454111002	HEADER STRAIGHT 2-PINS	1
454111006	HEADER STRAIGHT 6-PINS	1
454113003	HEADER STRAIGHT 3-PINS	1
454121003	BLOC FOR SOCKETS 3-PIN	1
454511020	HDR SOLD TAIL/MALE 20	1

PART: F9300-7

DESC: LTP 5446 PRINTER CONTROLLER

Component -----	Part Description -----	Qty Per Assembly -----
454511026	HDR SOLD TAIL/MALE 26	1
554435401	RIVET "RIVSCREW" M 3.5	3
719300703	PC BD PREASS'Y 9300-7	1
SM200330125	IC QUAD BUFFER 74HC125	1
SM207470175	IC QUAD DIFF LINE RECEIVER	4
SM208580336	IC REF DIODE LM336-2.5V	1
SM208650393	IC DUAL VOLT COMP LM393M	1
SM227080500	IC THERM PRINTER GATE ARRAY	1
SM227090501	IC THERM PRINTER CPU	1
SM236030099	DIODE SO-PKG BAV99	8
SM270330848	TRANSISTOR NPN BC848C	2
SM652101101	RES CHIP (E24) 1% 100 OHM	12
SM652101102	RES CHIP (E24) 1% 1 K	1
SM652101103	RES CHIP (E24) 1% 10 K	25
SM652101104	RES CHIP (E24) 1% 100 K	1
SM652101132	RES CHIP (E24) 1% 1.3 K	3
SM652101151	RES CHIP (E24) 1% 150 OHM	1
SM652101162	RES CHIP (E24) 1% 1.6 K	2
SM652101201	RES CHIP (E24) 1% 200 OHM	1
SM652101223	RES CHIP (E24) 1% 22 K	1
SM652101301	RES CHIP (E24) 1% 300 OHM	3
SM652101302	RES CHIP (E24) 1% 3 K	1
SM652101303	RES CHIP (E24) 1% 30 K	1
SM652101391	RES CHIP (E24) 1% 390 OHM	1
SM652101472	RES CHIP (E24) 1% 4.7 K	3
SM652101510	RES CHIP (E24) 1% 51 OHMS	1
SM652101513	RES CHIP (E24) 1% 51 K	1
SM652101514	RES CHIP (E24) 1% 510 K	1
SM652101563	RES CHIP (E24) 1% 56 K	2
SM652101621	RES CHIP (E24) 1% 620 OHM	2
SM652101682	RES CHIP (E24) 1% 6.8 K	1
SM654101000	CHIP JUMPER ZERO OHMS	1
SM661127104	CAP CERA CHIP 20% .1 UF	2
SM661207103	CAP CERA CHIP 20% .01UF	23
SM661255101	CAP CERA CHIP 5% 100 PF	1
SM661255471	CAP CERA CHIP 5% 470 PF	4
SM666377226	CAP MOLD TANT CHIP 22 UF	2

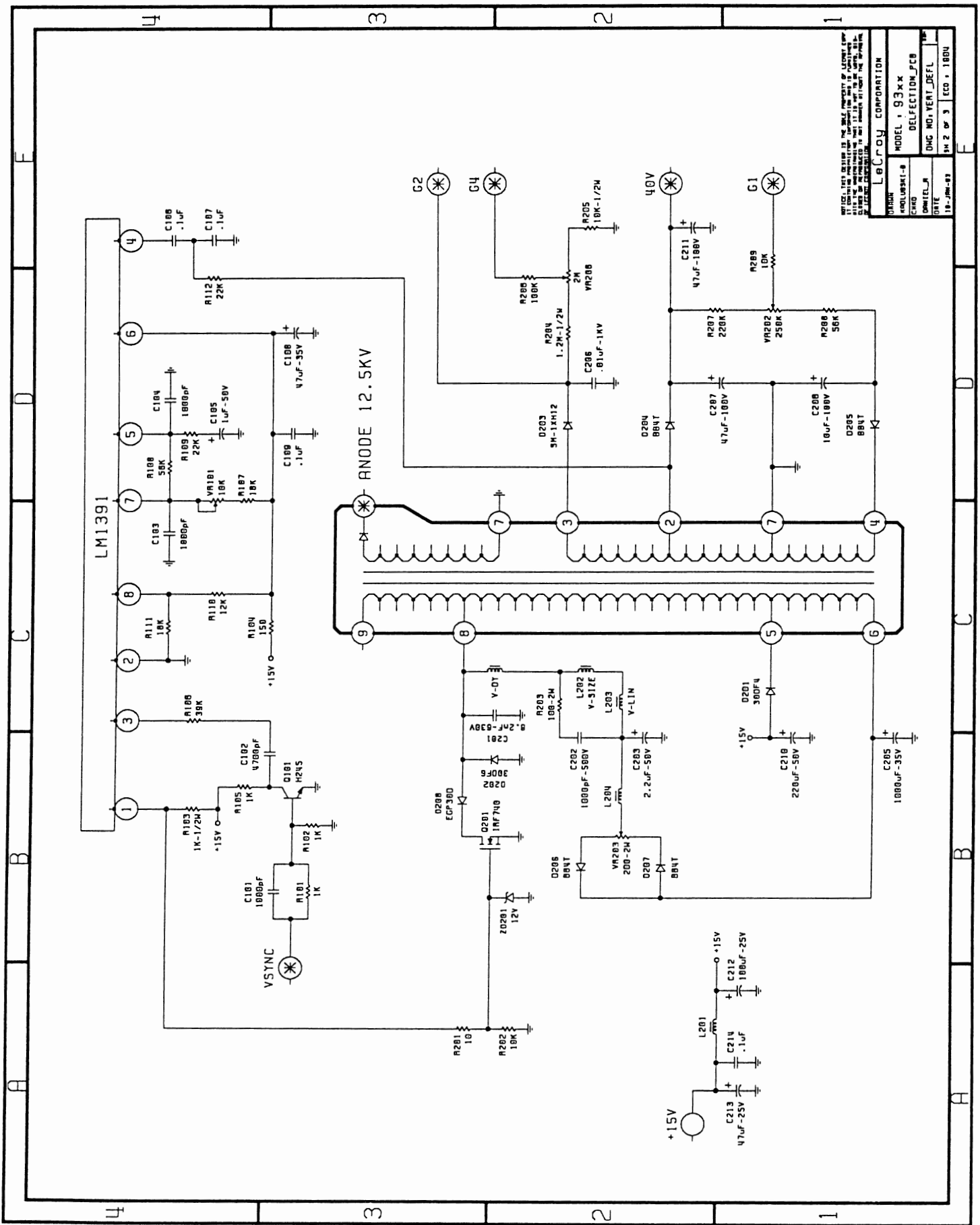

WHILE THIS DESIGN IS THE SOLE PROPERTY OF LECOROY CORPORATION, ALL RIGHTS ARE RESERVED. THIS DESIGN IS NOT TO BE REPRODUCED OR TRANSMITTED IN ANY FORM OR BY ANY MEANS, ELECTRONIC OR MECHANICAL, INCLUDING PHOTOCOPYING, RECORDING, OR BY ANY INFORMATION STORAGE AND RETRIEVAL SYSTEM, WITHOUT PERMISSION IN WRITING FROM LECOROY CORPORATION.

DRIVER	LECOROY CORPORATION		
MODEL	93 X X	DELFECTION PCB	
CIRCUIT		DHC NO. VERT. DEFL.	
DATE	18-JUN-93	REV. 2 OF 3	ECO - 18DU

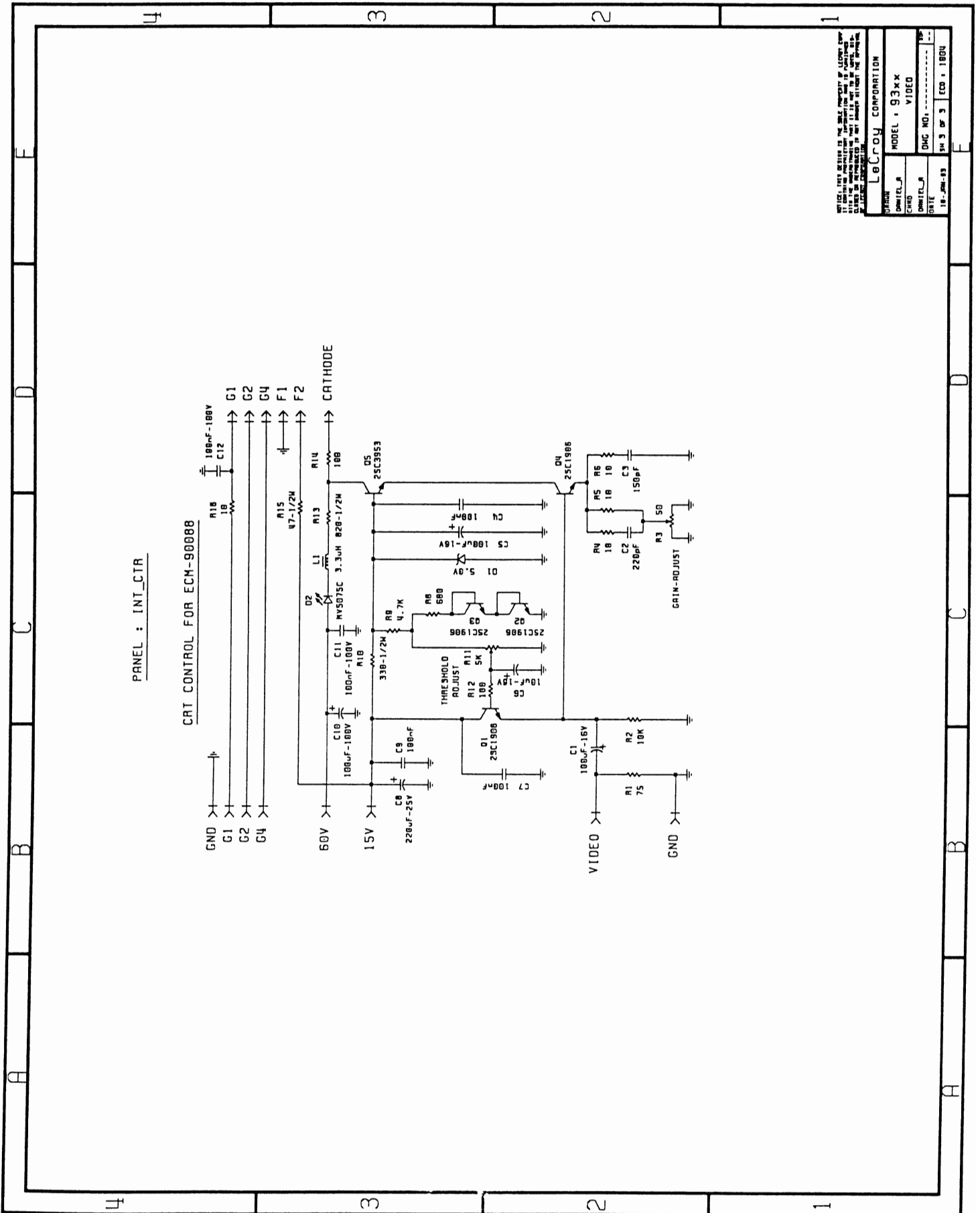

NOTICE: THIS DESIGN IS THE SOLE PROPERTY OF LEICROY COMPANY. IT IS TO BE KEPT SECRET AND NOT TO BE REPRODUCED OR TRANSMITTED IN ANY FORM OR BY ANY MEANS, ELECTRONIC OR MECHANICAL, INCLUDING PHOTOCOPYING, RECORDING, OR BY ANY INFORMATION STORAGE AND RETRIEVAL SYSTEM.

START	LEICROY CORPORATION
DESIGNER	MODEL : 93 X X
CHECKED	VIDEO
DATE	DWG NO. : -----
	14 X 3 OF 3 CD : 1804

PART : F93XX-DEFLECTION

Location	Description	Location	Description
-----	-----	-----	-----
C1	10uF	D202	30DF6
C2	680pF	D203	SM-1XH12
C3	22nF	D204	BB4T
C4	.1uF	D205	BB4T
C5	.1uF	D206	BB4T
C6	82nF	D207	BB4T
C7	.1uF	L201	5nH
C8	.1uF	V-DY	V-DY
C9	470uF	L202	V-SIZE
C10	.1uF	L203	V-LIN
C11	.1uF	L204	5nH
C12	470uF	Q1	A733P
C13	4.7nF250V	Q2	A733P
C14	1uF-63V	Q3	C945
C101	1000pF	Q4	A733P
C102	4700pF	Q5	J177
C103	1000pF	Q6	A733P
C104	1000pF	Q7	C945
C105	1uF-50V	Q8	A733P
C106	.1uF	Q9	C945
C107	.1uF	Q10	IRF630
C108	47uF-35V	Q11	C945
C109	.1uF	Q101	H245
C201	8.2nF-630V	Q201	IRF740
C202	1000pF-500V	R1	20K
C203	2.2uF-50V	R2	10K
C205	1000uF-35V	R4	6.65K-1%
C206	.01uF-1KV	R5	10K
C207	47uF-100V	R6	7.5K
C208	10uF-100V	R7	20K
C210	220uF-50V	R8	2.2M
C211	47uF-100V	R9	510K
C212	100uF-25V	R10	10M
C213	47uF-25V	R11	2.26K-1%
C214	.1uF	R12	13.3K-1%
D1	1N4448	R13	510K
D2	1N4448	R14	1M
D3	1N746A	R15	1K
D4	1N746A	R16	220
D5	BYV36C	R17	470
D6	1N758D	R18	1.5K
D7	1N758D	R19	10K
D8	1N5245B	R20	6.8K
D201	30DF4	R21	220K

PART : F93XX-DEFLECTION

Location	Description
-----	-----
R22	5K
R23	5K
R24	300
R25	30K
R26	510
R27	300
R28	7.5K
R29	2.7
R30	300
R31	300
R32	5K
R33	510
R34	300
R35	7.5K
R36	2.7
R37	910
R38	6.2-1/2W
R40	1.5K
R41	1.5K
R42	7.5K
R101	1K
R102	1K
R103	1K-1/2W
R104	150
R105	1K
R106	39K
R107	18K
R108	56K
R109	22K
R110	12K
R111	18K
R112	22K
R201	10
R202	10K
R203	100-2W
R204	1.2M-1/2W
R205	10K-1/2W
R206	100K
R207	220K
R208	56K
R209	10K
T201	HT
U1	LM3080
U2	LF353
U3	LF353

Location	Description
-----	-----
VR101	10K
VR202	250K
VR203	200-2W
VR206	2M
ZD201	12V

PART : F93XX-VIDEO

Location	Description
-----	-----
C1	100uF-16V
C2	220pF
C3	150pF
C4	100nF
C5	100uF-16V
C6	10uF-16V
C7	100nF
C8	220uF-25V
C9	100nF
C10	100uF-100V
C11	100nF-100V
C12	100nF-100V
D1	5.0V
D2	MV5075C
L1	3.3uH
Q1	2SC1906
Q2	2SC1906
Q3	2SC1906
Q4	2SC1906
Q5	2SC3953
R1	75
R2	10K
R3	50
R4	10
R5	10
R6	10
R8	680
R9	4.7K
R10	330-1/2W
R11	5K
R12	100
R13	820-1/2W
R14	100
R15	47-1/2W
R16	10

REVISIONS		EC	TC	DM	AMP
LTR	DESCRIPTION				
	SEE SHEET 1 FOR REVISIONS				

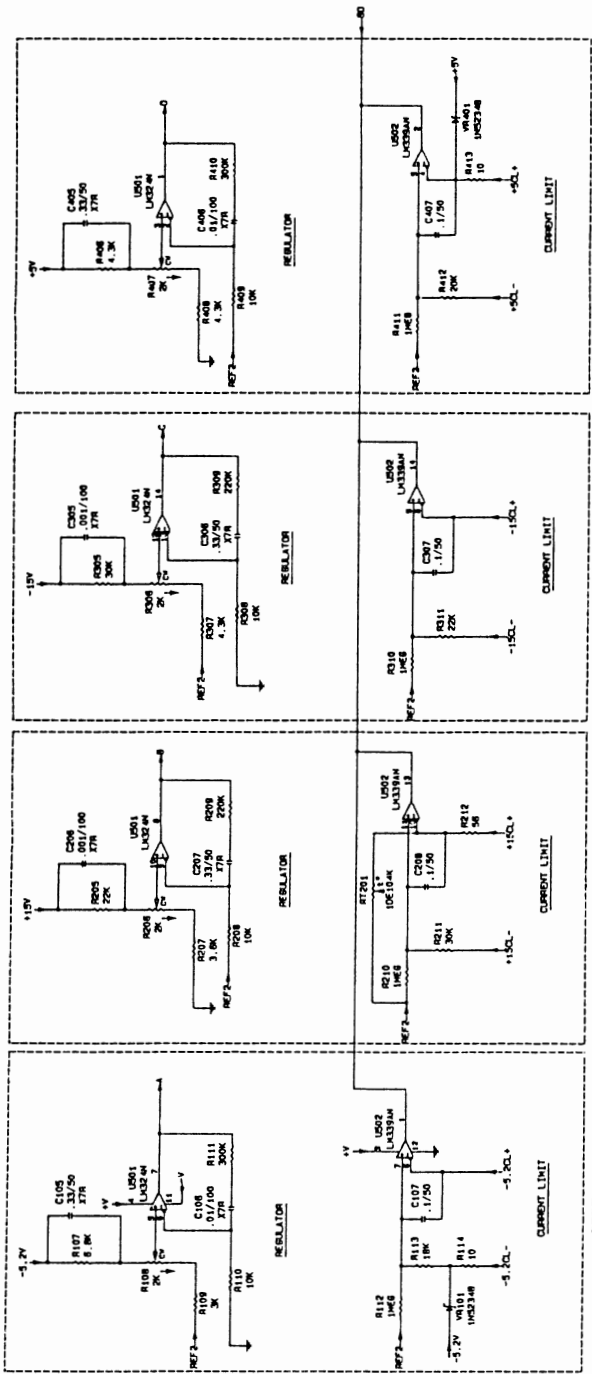

SEE SH1 FOR NOTES

NOTICE	POWER SYSTEM INC.
ALL DIMS AND ALL INFORMATION	PO BOX 1000
HEREON IS THE PROPERTY OF	NEWTON, MASS 02459
POWER SYSTEM INC.	BLOOMFIELD, CT 06002 USA
NO PARTS TO BE REPRODUCED	
APPROVAL / INIT. / DATE	TITLE
DRAWN: NLS 10-21-90	PS-1001 (REV C)
CHECK: _____	SCALE: _____
DESIGN: <u>UP-10/10/91</u>	SHEET: _____
DWG NO: _____	DATE: _____
DATE: _____	SCALE: _____
SAFETY: _____	DO NOT SCALE DRAWING

Section 8 Schematics, Layouts, Parts list

PART: M93XXA DESC: MECHANICAL FOR 9314A, 9314AM, 9314AL

Component -----	Part Description -----	Qty Per Assembly -----
377051005	LABEL "DANGER-----ONLY"	1
377131001	LABEL (GROUND SYMBOL)	1
407036002	FUSE HOLDER 2 POLE BLK 6.3X32	1
433162500	FUSE 250V/5A	2
434690002	LINE INPUT MODULE 250V/6A	1
485023462	FOOT BUMPON GREY	4
485123001	BUMPER (FOOT) SQUARE GREY RUB	2
530301009	BLK HANDLE W/2 BLACK END CAPS	1
550430106	SCREW CYL HD PHIL M3X6	11
550430116	SCREW CYL HD PHIL M3X16	6
550430120	SCREW CYL HD PHIL M3X20	12
550430508	SCREW FLAT HD PHIL M3X8	2
550430706	SCREW ECO-FIX M3X6	6
550440605	SCREW OVAL HD PHIL M4X5	8
550440608	SCREW OVAL PHIL M4X8	7
551430400	WASHER SHAKEPROOF M3	6
551450400	WASHER SHAKEPROOF M5	2
554030101	NUT BANC-LOK TYPE MV M3	7
554035101	CLIP-ON NUT DIAM. 3.5	4
554425003	SCREW S/TAP PHIL M2.5X6 BLACK	6
554435003	SCREW PT PHIL KA35X20	4
554435004	SCREW PT PHIL KA35X10	4
554435005	SCREW CYL HD PHIL 3.5X9.5	4
554440001	SCREW PT PHIL KA 40 X 12	4
554440202	FLAT WASHER M4	4
560032008	SCREW PHILIPS 10-32X1/2	2
594120003	TIEWRAP	1
709300911	LABEL CE	1
7093XX041	FOOT SUPPORT 93XX	2
7093XX051	FOOT 93XX	2
7093XX091	FRONT FRAME BRACKET 93XX	4
7093XX321	MAIN CARD STANDOFF 12MM	2
7093XX901	FAN 93XX-9 ASSEMBLY	1
7093XX931	INTERF. HOLE CLOSURE 93XX-9	2
709424096	INSERTION GUIDE FOR MC	1
780220033	BASE CARD POWER CABLE	1
780661104	FLAT CABLE 2X7 (4 CM)	1
780671110	FLAT CABLE 2X20 (10 CM)	1
780681611	PS1715 LINE INPUT CABLE	1
780721105	FLAT CABLE 2X10 (5,5CM)	1
780754515	GROUND CABLE YEL/GREEN 15CM	1
93XX-DISPLAY	RASTER MONITOR KIT	1
93XX-PS1715	DSO POWER SUPPLY W/SHIELDING	1
FF93X1	FRONT FRAME DSO 93XX	1

PART: M93XXA DESC: MECHANICAL FOR 9314A, 9314AM, 9314AL

Component -----	Part Description -----	Qty Per Assembly -----
LC93X1	LOWER COVER DSO 93XX	1
RP9314-9	REAR PANEL 9314-9	1
UC93X1	UPPER COVER DSO 93XX	1
US9314A-3	UPPER SHIELD ASSEMBLY	1

PART: ACCESSORIES-9314A DESC: ACCESSORIES FOR 9314A, 9314AM & 9314AL

Component -----	Part Description -----	Qty Per Assembly -----
407099008	PLUG FOR AC LINE -ENGLAND	1
433162500	FUSE 250V/5A	1
589202200	AC CORD/PLUG FOR GERMANY	1
589203100	AC CORD/"SEV-ASE" PLUG	1
589203218	AC CORD/US-CANADA PLUG	1
597930001	CARTON FOR 93XX	1
597930002	ETHAFOAM FOR 93XX	2
597940014	PLASTIC BAG FOR 94XX & 93XX	2
597940015	MANUAL/ACCESSORY CTN 9400	2
7093XX061	FRONT COVER 93XX	1
931X-OM-E	931X OPERATOR'S MANUAL - ENG	1
931X-OM-F	931X OPERATOR'S MANUAL - FREN	1
931X-OM-G	931X OPERATOR'S MANUAL - GERM	1
931X-OM-I	931X OPERATOR'S MANUAL - ITAL	1
931X-RCM-E	931X SERIES REMOTE CONTROL MAN	1
PP002	PASSIVE PROBE 10 MOHM 10:1	4

PART: 93XX-FDGP DESC: GRAPHIC PRINTER & FLOPPY DISK

Component -----	Part Description -----	Qty Per Assembly -----
334000402	THERMAL PAPER FOR SEIKO PRINT	1
334000832	THERMAL PRINTER UNIT	1
335023203	FLOPPY DISK DRIVE 3 1/2"	1
530040005	SLIDE LATCH TAB STYLE	2
550425104	SCREW CYL HD PHIL M2,5X4	4
550430106	SCREW CYL HD PHIL M3X6	6
551430100	FLAT WASHER M3	3
551430400	WASHER SHAKEPROOF M3	4
552430300	NUT OPEN-END ACORN M3	3
554030101	NUT BANC-LOK TYPE MV M3	2
554430002	SCREW S/TAP PHIL M3X5	10
594120003	TIE WRAP	2
709450523	PUSH SWITCH EXTENDER	1
70FD01021	FLOPPY DISK DRIVE SUPPORT	1
70FD01031	FLOPPY DISK DRIVE FRAME	1
70GP01031	GRAPHIC PRINTER FRAME	1
70GP01041	GRAPHIC PRINTER COVER AXLE	1
70GP01051	GRAPHIC PRINTER CUTTER	1
70GP01061	GRAPHIC PRINTER SWITCH BUTTON	1
780210030	DISPLAY POWER CABLE	1
780721022	FLAT CABLE 2X10 (22CM)	1
780791604	FLAT CABLE 2X13 (4CM)	1
780791630	FLAT CABLE 2X13 (30CM)	1
780801015	FLAT CABLE 2X20 (3 CONNECT.)	1
BOX-GP01	GP01 GRAPHIC PRINTER BOX	1
COVER-GP01	GP01 GRAPHIC PRINTER COVER	1
CUP-FD01	FD01 FLOPPY DISK DRIVE CUP	1
F9300-6	CENTRONICS/FLOPPY/PRINTER INT	1
F9300-7	LTP 5446 PRINTER CONTROLLER	1
UC93X1-FDGP	UPPER COVER FOR FD/GP OPTIONS	1

PART: 93XX-FD01 DESC: FLOPPY DISK

Component -----	Part Description -----	Qty Per Assembly -----
335023203	FLOPPY DISK DRIVE 3 1/2"	1
550425104	SCREW CYL HD PHIL M2,5X4	4
550430106	SCREW CYL HD PHIL M3X6	4
551430400	WASHER SHAKEPROOF M3	2
551430400	WASHER SHAKEPROOF M3	2
554030101	NUT BANC-LOCK TYPE MV M3	2
554430002	SCREW S/TAP PHIL M3X5	4
70FD01021	FLOPPY DISK DRIVE SUPPORT	1
70FD01031	FLOPPY DISK DRIVE FRAME	1
780791630	FLAT CABLE 2X13 (30CM)	1
780801015	FLAT CABLE 2X20 (3 CONNECT.)	1
CUP-FD01	FD01 FLOPPY DISK DRIVE CUP	1
F9300-6	CENTRONICS/FLOPPY/PRINTER INT. B	1
UC93X1-FD01	UPPER COVER FOR FD01 OPTION	1

PART: 93XX-GP01 DESC: GRAPHICS PRINTER

Component -----	Part Description -----	Qty Per Assembly -----
340000402	THERMAL PAPER FOR SEIKO PRINT	1
334000832	THERMAL PRINTER UNIT	1
530040005	SLIDE LATCH TAB STYLE	2
550430106	SCREW CYL HD PHIL M3X6	4
551430100	FLAT WASHER M3	3
551430400	WASHER SHAKEPROOF M3	4
552430300	NUT OPEN-END ACORN M3	3
554430002	SCREW S/TAP PHIL M3X5	6
594120003	TIE WRAP	2
709450523	PUSH SWITCH EXTENDER	1
70GP01031	GRAPHIC PRINTER FRAME	1
70GP01041	GRAPHIC PRINTER COVER AXLE	1
70GP01051	GRAPHIC PRINTER CUTTER	1
70GP01061	GRAPHIC PRINTER SWITCH BUTTON	1
780210030	DISPLAY POWER CABLE	1
780721022	FLAT CABLE 2X10 (22CM)	1
780791604	FLAT CABLE 2X13 (4CM)	1
780801015	FLAT CABLE 2X20 (3 CONNECT.)	1
BOX-GP01	GP01 GRAPHIC PRINTER BOX	1
COVER-GP01	GP01 GRAPHIC PRINTER COVER	1
F9300-6	CENTRONICS/FLOPPY/PRINTER INT	1
F9300-7	LTP 5446 PRINTER CONTROLLER	1
UC93X1-GP01	UPPER COVER FOR GP01 OPTION	1

PART: 9300-8

DESC: PCMCIA III, HARD DISK CONTROLLER

Component -----	Part Description -----	Qty Per Assembly -----
205750000	IC AND-OR GATE ARRAY 16V8	2
330100100	PCMCIA HEADER ASS'Y TOP/LEFT	1
389340009	AUTO-ADHES. RUBBER BAND 12X4MM	5
454511040	HDR SOLD TAIL/MALE/40/RT	1
550120606	SCREW OVAL HD PHIL M2X6	4
550430106	SCREW CYL HD PHIL M3X6	4
551430400	WASHER SHAKEPROOF M3	4
552120100	NUT HEX M2X0.5D	4
709300811	9300-8 PCMCIA III CONT.BRACKET A	1
709300821	9300-8 PCMCIA III CONT. COVER A	1
709300831	9300-8 PCMCIA III CONTR. LABEL A	1
719300803	PC BD PREASS'Y 9300-8	1
SM200178002	IC 2-INPUT NOR HCT02	1
SM200178374	IC D-TYP FLOP 74HCT374	2
SM201178175	IC QUAD D FLIP/FLOP 74HCT175	1
SM206885245	IC BUS TRANSCVR ABT245	1
SM207170036	IC HEX BUFFER 3-ST. PC74HCT365	3
SM208476482	IC DUAL OP AMP RAIL-RAIL 6482	1
SM208780109	IC MICROPOWER DC-DC CONV.	1
SM232032814	DIODE 2814	4
SM275330858	TRANSISTOR PNP BC858C	1
SM280171005	TRANS POWER MOSFET MTD10N05E	1
SM300056332	INDUCTOR WOUND 33 UH	1
SM652101102	RES CHIP (E24) 1% 1 K	3
SM652101103	RES CHIP (E24) 1% 10 K	18
SM652101104	RES CHIP (E24) 1% 100 K	2
SM652101220	RES CHIP (E24) 1% 22 OHMS	1
SM652101334	RES CHIP (E24) 1% 330 K	3
SM654101000	CHIP JUMPER ZERO OHMS	1
SM661207103	CAP CERA CHIP 20% .01UF (0805)	10
SM661207104	CAP CERA CHIP 20% .1 UF	6
SM661255101	CAP CERA CHIP 5% 100 PF	1
SM666327225	CAP MOLD TANT CHIP 2.2 UF	1
SM666377226	CAP MOLD TANT CHIP 22 UF	3

PART: F9314A-3 DESC: MAIN CARD (FRONT END, ADC, TDC) FOR 9314A/M/L

Location	Part Number	Description	Location	Part Number	Description
A416	SM208030245	SMSL3245	A2003	MFE409	MFE409
A417	SM200167131	SM10H131	A2004	SM289772003	SMULN2003
A418	SM207360125	SM10125	A2005	SM205618594	SM74HC594-PS
A419	SM200167131	SM10H131	A2006	SM207770403	SMDG403-PS
A420	SM207460116	SM10H116	A2007	SM208470358	SMLM358
A421	SM208470353	SMLF353	A2008	SM205618594	SM74HC594-PS
A422	SM200178002	SM74HCT02	A2009	SM200178002	SM74HCT02-PS
A423	SM207360125	SM10125	A2500	HSH410	HSH410
A424	SM207360125	SM10125	A2501	SM208470324	SMLM324
A425	MTB411	MTB411	A2502	207200508	SP97508B
A426	SM200178002	SM74HCT02	A2503	SM207360125	SM10125
A427	SM201177109	SM74ACT109	A2504	SM207360125	SM10125
A428	SM201177109	SM74ACT109	A2505	MDX407	MDX407
A429	SM201177032	SM74ACT32	A2506	SRAM9314-3	SRAM9314-3
A430	SM201177008	SM74ACT08	A2507	SRAM9314-3	SRAM9314-3
A431	SM200178074	SM74HCT74	A2508	SRAM9314-3	SRAM9314-3
A438	SM207978251	SM74HCT251	A2509	SRAM9314-3	SRAM9314-3
A439	SM200178273	SM74HCT273	A2510	SRAM9314-3	SRAM9314-3
A1000	SM208870339	SMLM339	A2511	SRAM9314-3	SRAM9314-3
A1001	SM208470705	SMAD705	A2512	SRAM9314-3	SRAM9314-3
A1002	SM207770201	SMDG201-PS	A2513	SRAM9314-3	SRAM9314-3
A1003	MFE409	MFE409	A3000	SM208870339	SMLM339
A1004	SM289772003	SMULN2003	A3001	SM208470705	SMAD705
A1005	SM205618594	SM74HC594-PS	A3002	SM207770201	SMDG201-PS
A1006	SM207770403	SMDG403-PS	A3003	MFE409	MFE409
A1007	SM208470358	SMLM358	A3004	SM289772003	SMULN2003
A1008	SM205618594	SM74HC594-PS	A3005	SM205618594	SM74HC594-PS
A1009	SM200178002	SM74HCT02-PS	A3006	SM207770403	SMDG403-PS
A1500	HSH410	HSH410	A3007	SM208470358	SMLM358
A1501	SM208470324	SMLM324	A3008	SM205618594	SM74HC594-PS
A1502	207200508	SP97508B	A3009	SM200178002	SM74HCT02-PS
A1503	SM207360125	SM10125	A3500	HSH410	HSH410
A1504	SM207360125	SM10125	A3501	SM208470324	SMLM324
A1505	MDX407	MDX407	A3502	207200508	SP97508B
A1506	SRAM9314-3	SRAM9314-3	A3503	SM207360125	SM10125
A1507	SRAM9314-3	SRAM9314-3	A3504	SM207360125	SM10125
A1508	SRAM9314-3	SRAM9314-3	A3505	MDX407	MDX407
A1509	SRAM9314-3	SRAM9314-3	A3506	SRAM9314-3	SRAM9314-3
A1510	SRAM9314-3	SRAM9314-3	A3507	SRAM9314-3	SRAM9314-3
A1511	SRAM9314-3	SRAM9314-3	A3508	SRAM9314-3	SRAM9314-3
A1512	SRAM9314-3	SRAM9314-3	A3509	SRAM9314-3	SRAM9314-3
A1513	SRAM9314-3	SRAM9314-3	A3510	SRAM9314-3	SRAM9314-3
A2000	SM208870339	SMLM339	A3511	SRAM9314-3	SRAM9314-3
A2001	SM208470705	SMAD705	A3512	SRAM9314-3	SRAM9314-3
A2002	SM207770201	SMDG201-PS	A3513	SRAM9314-3	SRAM9314-3

PART: F9314A-3 DESC: MAIN CARD (FRONT END, ADC, TDC) FOR 9314A/M/L

Location	Part Number	Description	Location	Part Number	Description
A4000	SM208870339	SMLM339	C8	SM661207103	SM.01uFS
A4001	SM208470705	SMAD705	C10	SM661207103	SM.01uFS
A4002	SM207770201	SMDG201-PS	C11	SM661207103	SM.01uFS
A4003	MFE409	MFE409	C12	SM661207103	SM.01uFS
A4004	SM289772003	SMULN2003	C13	SM661207103	SM.01uFS
A4005	SM205618594	SM74HC594-PS	C14	SM666377226	SM22uF-15V
A4006	SM207770403	SMDG403-PS	C15	SM661207103	SM.01uFS
A4007	SM208470358	SMLM358	C16	SM661207103	SM.01uFS
A4008	SM205618594	SM74HC594-PS	C17	SM661207103	SM.01uFS
A4009	SM200178002	SM74HCT02-PS	C18	SM661207103	SM.01uFS
A4500	HSH410	HSH410	C19	SM661207103	SM.01uFS
A4501	SM208470324	SMLM324	C20	SM661207103	SM.01uFS
A4502	207200508	SP97508B	C21	SM661207103	SM.01uFS
A4503	SM207360125	SM10125	C22	SM661207103	SM.01uFS
A4504	SM207360125	SM10125	C23	SM661207103	SM.01uFS
A4505	MDX407	MDX407	C24	SM661127104	SM.1uF
A4506	SRAM9314-3	SRAM9314-3	C25	SM666377226	SM22uF-15V
A4507	SRAM9314-3	SRAM9314-3	C26	SM661127104	SM.1uF
A4508	SRAM9314-3	SRAM9314-3	C27	SM661207103	SM.01uFS
A4509	SRAM9314-3	SRAM9314-3	C28	SM661207103	SM.01uFS
A4510	SRAM9314-3	SRAM9314-3	C29	SM666247106	SM10uF-25V
A4511	SRAM9314-3	SRAM9314-3	C30	146544471	470uF-25V
A4512	SRAM9314-3	SRAM9314-3	C31	SM666247106	SM10uF-25V
A4513	SRAM9314-3	SRAM9314-3	C32	SM661207103	SM.01uFS
A5000	SM208470705	SMAD705	C33	SM666247106	SM10uF-25V
A5001	MTR408	MTR408	C34	SM666247106	SM10uF-25V
A5002	MTR408	MTR408	C35	SM661207103	SM.01uFS
A5003	SM207978153	SM74HCT153-PS	C36	SM661207103	SM.01uFS
A5004	SM205618594	SM74HC594-PS	C40	SM661207103	SM.01uFS
A5005	SM205618594	SM74HC594-PS	C42	SM661207103	SM.01uFS
A5006	SM207770442	SMDG442-PS	C60	SM661207104	SM.1uFS
A5007	SM208971881	SMLM1881	C61	SM661207103	SM.01uFS
A5008	SM205618594	SM74HC594-PS	C70	SM666327225	SM2.2uF-20V
A5009	SM205618594	SM74HC594-PS	C71	SM661207104	SM.1uFS
A5010	SM207770442	SMDG442-PS	C72	SM661207104	SM.1uFS
A5011	SM208470037	SMOP37	C73	SM661207104	SM.1uFS
A5012	SM208870339	SMLM339	C74	SM661207104	SM.1uFS
A6000	SM208470353	SMLF353	C75	SM661207104	SM.1uFS
C1	SM661207103	SM.01uFS	C76	SM661207104	SM.1uFS
C2	SM661255181	SM180pFS	C77	SM661207104	SM.1uFS
C3	SM661207103	SM.01uFS	C78	SM661207104	SM.1uFS
C4	SM661207104	SM.1uFS	C79	SM666327225	SM2.2uF-20V
C5	SM661207103	SM.01uFS	C100	SM661726103	SM.01uF
C6	SM661207103	SM.01uFS	C101	SM661726103	SM.01uF
C7	SM661207103	SM.01uFS	C102	SM661207103	SM.01uFS

PART: F9314A-3 DESC: MAIN CARD (FRONT END, ADC, TDC) FOR 9314A/M/L

Location	Part Number	Description	Location	Part Number	Description
-----	-----	-----	-----	-----	-----
C103	SM661207103	SM.01uFS	C209	SM661207103	SM.01uFS
C104	SM661726103	SM.01uF	C210	SM661207103	SM.01uFS
C105	SM661726103	SM.01uF	C211	SM661207103	SM.01uFS
C106	SM661207103	SM.01uFS	C212	SM661207103	SM.01uFS
C107	SM661207103	SM.01uFS	C213	SM661207103	SM.01uFS
C108	SM661207103	SM.01uFS	C214	SM661207103	SM.01uFS
C109	SM661207103	SM.01uFS	C215	SM661207103	SM.01uFS
C110	SM661726103	SM.01uF	C217	SM661207103	SM.01uFS
C111	SM661726103	SM.01uF	C218	SM661207103	SM.01uFS
C112	SM661207103	SM.01uFS	C219	SM661207103	SM.01uFS
C113	SM661207103	SM.01uFS	C220	SM661207103	SM.01uFS
C114	SM661726103	SM.01uF	C221	SM661207103	SM.01uFS
C115	SM661726103	SM.01uF	C222	SM661207103	SM.01uFS
C116	SM661207103	SM.01uFS	C223	SM661207103	SM.01uFS
C117	SM661207103	SM.01uFS	C224	SM661207103	SM.01uFS
C118	SM661207103	SM.01uFS	C225	SM661207103	SM.01uFS
C119	SM661726103	SM.01uF	C226	SM666237476	SM47uF-6V
C120	SM661726103	SM.01uF	C227	SM666247106	SM10uF-25V
C122	SM661207103	SM.01uFS	C228	SM666247106	SM10uF-25V
C123	SM661207103	SM.01uFS	C229	SM666247106	SM10uF-25V
C124	SM661207103	SM.01uFS	C235	SM661207103	SM.01uFS
C125	SM661726103	SM.01uF	C236	SM661207103	SM.01uFS
C126	SM661726103	SM.01uF	C237	SM661207103	SM.01uFS
C127	SM661207103	SM.01uFS	C238	SM661207103	SM.01uFS
C128	SM661207103	SM.01uFS	C400	SM661207103	SM.01uFS
C129	SM661207103	SM.01uFS	C401	SM661207103	SM.01uFS
C130	SM666327225	SM2.2uF-20V	C402	SM661207103	SM.01uFS
C131	SM666327225	SM2.2uF-20V	C403	SM661207103	SM.01uFS
C132	SM666327225	SM2.2uF-20V	C405	SM661207103	SM.01uFS
C133	SM666327225	SM2.2uF-20V	C406	SM661207103	SM.01uFS
C140	SM666327225	SM2.2uF-20V	C408	SM661207103	SM.01uFS
C141	SM666327225	SM2.2uF-20V	C410	SM661207103	SM.01uFS
C142	SM666327225	SM2.2uF-20V	C411	SM158240200	SM0.6-2.5pF
C143	SM666327225	SM2.2uF-20V	C412	SM661207103	SM.01uFS
C144	SM661207104	SM.1uFS	C413	SM661207103	SM.01uFS
C145	SM661207103	SM.01uFS	C414	SM661207103	SM.01uFS
C200	SM666247106	SM10uF-25V	C415	SM661207103	SM.01uFS
C201	SM666237476	SM47uF-6V	C416	SM661207103	SM.01uFS
C202	SM666247106	SM10uF-25V	C417	SM661207103	SM.01uFS
C203	SM666247106	SM10uF-25V	C418	SM661207103	SM.01uFS
C204	SM666237476	SM47uF-6V	C419	SM661207103	SM.01uFS
C205	SM661207103	SM.01uFS	C420	SM661207103	SM.01uFS
C206	SM661207103	SM.01uFS	C421	SM661255560	SM56pFS
C207	SM661207103	SM.01uFS	C422	SM661207103	SM.01uFS
C208	SM661207103	SM.01uFS	C423	SM661207103	SM.01uFS

PART: F9314A-3 DESC: MAIN CARD (FRONT END, ADC, TDC) FOR 9314A/M/L

Location	Part Number	Description	Location	Part Number	Description
C424	SM661255270	SM27pFS	C1000	SM661207104	SM.1uFS
C425	SM661256120	SM12pFS	C1001	SM661207103	SM.01uFS
C426	SM158043006	SM2-6pF	C1002	SM661207103	SM.01uFS
C427	SM661207103	SM.01uFS	C1003	SM661127104	SM.1uF
C428	SM661207103	SM.01uFS	C1004	SM661207104	SM.1uFS
C429	SM661207103	SM.01uFS	C1005	SM661255056	SM5.6pFS
C430	SM661207103	SM.01uFS	C1006	SM661207103	SM.01uFS
C431	SM661207103	SM.01uFS	C1007	SM661207103	SM.01uFS
C432	SM661207103	SM.01uFS	C1008	SM661127104	SM.1uF
C433	SM661207103	SM.01uFS	C1009	158849012	5-15pF-S
C434	SM661207103	SM.01uFS	C1010	SM661256120	SM12pFS
C435	SM661207103	SM.01uFS	C1011	SM661255056	SM5.6pFS
C436	SM661207103	SM.01uFS	C1012	SM661255820	SM82pFS
C437	SM661207103	SM.01uFS	C1013	SM661207103	SM.01uFS
C438	SM661207103	SM.01uFS	C1014	SM661495561	SM560pFS-500V
C439	SM661207103	SM.01uFS	C1015	SM661127104	SM.1uF
C440	SM661207103	SM.01uFS	C1016	SM661207103	SM.01uFS
C441	SM661207103	SM.01uFS	C1017	SM661207103	SM.01uFS
C442	SM661207103	SM.01uFS	C1018	SM661207103	SM.01uFS
C443	SM661207103	SM.01uFS	C1019	SM661207223	SM.022uFS
C444	SM661207103	SM.01uFS	C1020	SM661207103	SM.01uFS
C445	SM661207103	SM.01uFS	C1021	SM661207103	SM.01uFS
C446	SM661207103	SM.01uFS	C1022	SM661127104	SM.1uF
C447	SM661255101	SM100pFS	C1023	SM661207103	SM.01uFS
C448	SM661207103	SM.01uFS	C1024	SM661207103	SM.01uFS
C449	SM661207103	SM.01uFS	C1025	SM661207103	SM.01uFS
C450	SM661207103	SM.01uFS	C1026	SM661250082	SM8.2pFS
C451	SM661207103	SM.01uFS	C1027	SM661207103	SM.01uFS
C452	SM661207103	SM.01uFS	C1028	158849009	0.5-2.5pF-S
C454	SM661207103	SM.01uFS	C1029	SM661255220	SM22pFS
C455	SM661207103	SM.01uFS	C1030	SM661207103	SM.01uFS
C456	SM661207103	SM.01uFS	C1031	SM661207103	SM.01uFS
C457	SM661255056	SM5.6pFS	C1032	SM661207103	SM.01uFS
C459	SM661255270	SM27pFS	C1034	SM661207103	SM.01uFS
C461	SM661207103	SM.01uFS	C1035	SM661207103	SM.01uFS
C462	SM661207103	SM.01uFS	C1036	SM661207103	SM.01uFS
C464	SM661255330	SM33pFS	C1037	SM661207103	SM.01uFS
C467	SM661207103	SM.01uFS	C1039	SM661255101	SM100pFS
C470	SM661207103	SM.01uFS	C1040	SM661207103	SM.01uFS
C474	SM661207103	SM.01uFS	C1041	SM661207103	SM.01uFS
C476	SM661207103	SM.01uFS	C1042	SM661207103	SM.01uFS
C478	SM661255270	SM27pFS	C1043	SM661207103	SM.01uFS
C480	SM661207103	SM.01uFS	C1044	SM661207103	SM.01uFS
C481	SM661207103	SM.01uFS	C1045	SM661207103	SM.01uFS
C485	SM661207103	SM.01uFS	C1046	SM661207103	SM.01uFS

PART: F9314A-3 DESC: MAIN CARD (FRONT END, ADC, TDC) FOR 9314A/M/L

Location	Part Number	Description	Location	Part Number	Description
C1047	SM661207103	SM.01uFS	C2008	SM661127104	SM.1uF
C1048	SM661207103	SM.01uFS	C2009	158849012	5-15pF-S
C1049	SM661207103	SM.01uFS	C2010	SM661256120	SM12pFS
C1050	SM661207103	SM.01uFS	C2011	SM661255056	SM5.6pFS
C1051	SM661207103	SM.01uFS	C2012	SM661255820	SM82pFS
C1052	SM666327225	SM2.2uF-20V	C2013	SM661207103	SM.01uFS
C1053	SM666327225	SM2.2uF-20V	C2014	SM661495561	SM560pFS-500V
C1054	SM666327225	SM2.2uF-20V	C2015	SM661127104	SM.1uF
C1055	SM666327225	SM2.2uF-20V	C2016	SM661207103	SM.01uFS
C1056	SM666327225	SM2.2uF-20V	C2017	SM661207103	SM.01uFS
C1057	SM661255181	SM180pFS	C2018	SM661207103	SM.01uFS
C1058	SM661255270	SM27pFS	C2019	SM661207223	SM.022uFS
C1059	SM661207103	SM.01uFS	C2020	SM661207103	SM.01uFS
C1500	SM661207103	SM.01uFS	C2021	SM661207103	SM.01uFS
C1501	SM661207103	SM.01uFS	C2022	SM661127104	SM.1uF
C1502	SM661207103	SM.01uFS	C2023	SM661207103	SM.01uFS
C1503	SM661207103	SM.01uFS	C2024	SM661207103	SM.01uFS
C1504	SM661207103	SM.01uFS	C2025	SM661207103	SM.01uFS
C1505	SM661207103	SM.01uFS	C2026	SM661250082	SM8.2pFS
C1506	SM661207103	SM.01uFS	C2027	SM661207103	SM.01uFS
C1507	SM661207103	SM.01uFS	C2028	158849009	0.5-2.5pF-S
C1510	SM666237476	SM47uF-6V	C2029	SM661255220	SM22pFS
C1511	SM661207103	SM.01uFS	C2030	SM661207103	SM.01uFS
C1512	SM661207103	SM.01uFS	C2031	SM661207103	SM.01uFS
C1513	SM661207103	SM.01uFS	C2032	SM661207103	SM.01uFS
C1514	SM661207103	SM.01uFS	C2034	SM661207103	SM.01uFS
C1515	SM661207103	SM.01uFS	C2035	SM661207103	SM.01uFS
C1516	SM661207103	SM.01uFS	C2036	SM661207103	SM.01uFS
C1517	SM661207103	SM.01uFS	C2037	SM661207103	SM.01uFS
C1518	SM661207103	SM.01uFS	C2039	SM661255101	SM100pFS
C1519	SM661207103	SM.01uFS	C2040	SM661207103	SM.01uFS
C1520	SM661207103	SM.01uFS	C2041	SM661207103	SM.01uFS
C1521	SM661207103	SM.01uFS	C2042	SM661207103	SM.01uFS
C1522	SM661207103	SM.01uFS	C2043	SM661207103	SM.01uFS
C1523	SM661207103	SM.01uFS	C2044	SM661207103	SM.01uFS
C1524	SM661207103	SM.01uFS	C2045	SM661207103	SM.01uFS
C1525	SM661207103	SM.01uFS	C2046	SM661207103	SM.01uFS
C2000	SM661207104	SM.1uFS	C2047	SM661207103	SM.01uFS
C2001	SM661207103	SM.01uFS	C2048	SM661207103	SM.01uFS
C2002	SM661207103	SM.01uFS	C2049	SM661207103	SM.01uFS
C2003	SM661127104	SM.1uF	C2050	SM661207103	SM.01uFS
C2004	SM661207104	SM.1uFS	C2051	SM661207103	SM.01uFS
C2005	SM661255056	SM5.6pFS	C2052	SM666327225	SM2.2uF-20V
C2006	SM661207103	SM.01uFS	C2053	SM666327225	SM2.2uF-20V
C2007	SM661207103	SM.01uFS	C2054	SM666327225	SM2.2uF-20V

PART: F9314A-3 DESC: MAIN CARD (FRONT END, ADC, TDC) FOR 9314A/M/L

Location	Part Number	Description	Location	Part Number	Description
C2055	SM666327225	SM2.2uF-20V	C3016	SM661207103	SM.01uFS
C2056	SM666327225	SM2.2uF-20V	C3017	SM661207103	SM.01uFS
C2057	SM661255181	SM180pFS	C3018	SM661207103	SM.01uFS
C2058	SM661255270	SM27pFS	C3019	SM661207223	SM.022uFS
C2059	SM661207103	SM.01uFS	C3020	SM661207103	SM.01uFS
C2500	SM661207103	SM.01uFS	C3021	SM661207103	SM.01uFS
C2501	SM661207103	SM.01uFS	C3022	SM661127104	SM.1uF
C2502	SM661207103	SM.01uFS	C3023	SM661207103	SM.01uFS
C2503	SM661207103	SM.01uFS	C3024	SM661207103	SM.01uFS
C2504	SM661207103	SM.01uFS	C3025	SM661207103	SM.01uFS
C2505	SM661207103	SM.01uFS	C3026	SM661250082	SM8.2pFS
C2506	SM661207103	SM.01uFS	C3027	SM661207103	SM.01uFS
C2507	SM661207103	SM.01uFS	C3028	158849009	0.5-2.5pF-S
C2510	SM666237476	SM47uF-6V	C3029	SM661255220	SM22pFS
C2511	SM661207103	SM.01uFS	C3030	SM661207103	SM.01uFS
C2512	SM661207103	SM.01uFS	C3031	SM661207103	SM.01uFS
C2513	SM661207103	SM.01uFS	C3032	SM661207103	SM.01uFS
C2514	SM661207103	SM.01uFS	C3034	SM661207103	SM.01uFS
C2515	SM661207103	SM.01uFS	C3035	SM661207103	SM.01uFS
C2516	SM661207103	SM.01uFS	C3036	SM661207103	SM.01uFS
C2517	SM661207103	SM.01uFS	C3037	SM661207103	SM.01uFS
C2518	SM661207103	SM.01uFS	C3039	SM661255101	SM100pFS
C2519	SM661207103	SM.01uFS	C3040	SM661207103	SM.01uFS
C2520	SM661207103	SM.01uFS	C3041	SM661207103	SM.01uFS
C2521	SM661207103	SM.01uFS	C3042	SM661207103	SM.01uFS
C2522	SM661207103	SM.01uFS	C3043	SM661207103	SM.01uFS
C2523	SM661207103	SM.01uFS	C3044	SM661207103	SM.01uFS
C2524	SM661207103	SM.01uFS	C3045	SM661207103	SM.01uFS
C2525	SM661207103	SM.01uFS	C3046	SM661207103	SM.01uFS
C3000	SM661207104	SM.1uFS	C3047	SM661207103	SM.01uFS
C3001	SM661207103	SM.01uFS	C3048	SM661207103	SM.01uFS
C3002	SM661207103	SM.01uFS	C3049	SM661207103	SM.01uFS
C3003	SM661127104	SM.1uF	C3050	SM661207103	SM.01uFS
C3004	SM661207104	SM.1uFS	C3051	SM661207103	SM.01uFS
C3005	SM661255056	SM5.6pFS	C3052	SM666327225	SM2.2uF-20V
C3006	SM661207103	SM.01uFS	C3053	SM666327225	SM2.2uF-20V
C3007	SM661207103	SM.01uFS	C3054	SM666327225	SM2.2uF-20V
C3008	SM661127104	SM.1uF	C3055	SM666327225	SM2.2uF-20V
C3009	158849012	5-15pF-S	C3056	SM666327225	SM2.2uF-20V
C3010	SM661256120	SM12pFS	C3057	SM661255181	SM180pFS
C3011	SM661255056	SM5.6pFS	C3058	SM661255270	SM27pFS
C3012	SM661255820	SM82pFS	C3059	SM661207103	SM.01uFS
C3013	SM661207103	SM.01uFS	C3500	SM661207103	SM.01uFS
C3014	SM661495561	SM560pFS-500V	C3501	SM661207103	SM.01uFS
C3015	SM661127104	SM.1uF	C3502	SM661207103	SM.01uFS

PART: F9314A-3 DESC: MAIN CARD (FRONT END, ADC, TDC) FOR 9314A/M/L

Location	Part Number	Description	Location	Part Number	Description
C3503	SM661207103	SM.01uFS	C4024	SM661207103	SM.01uFS
C3504	SM661207103	SM.01uFS	C4025	SM661207103	SM.01uFS
C3505	SM661207103	SM.01uFS	C4026	SM661250082	SM8.2pFS
C3506	SM661207103	SM.01uFS	C4027	SM661207103	SM.01uFS
C3507	SM661207103	SM.01uFS	C4028	158849009	0.5-2.5pF-S
C3510	SM666237476	SM47uF-6V	C4029	SM661255220	SM22pFS
C3511	SM661207103	SM.01uFS	C4030	SM661207103	SM.01uFS
C3512	SM661207103	SM.01uFS	C4031	SM661207103	SM.01uFS
C3513	SM661207103	SM.01uFS	C4032	SM661207103	SM.01uFS
C3514	SM661207103	SM.01uFS	C4034	SM661207103	SM.01uFS
C3515	SM661207103	SM.01uFS	C4035	SM661207103	SM.01uFS
C3516	SM661207103	SM.01uFS	C4036	SM661207103	SM.01uFS
C3517	SM661207103	SM.01uFS	C4037	SM661207103	SM.01uFS
C3518	SM661207103	SM.01uFS	C4039	SM661255101	SM100pFS
C3519	SM661207103	SM.01uFS	C4040	SM661207103	SM.01uFS
C3520	SM661207103	SM.01uFS	C4041	SM661207103	SM.01uFS
C3521	SM661207103	SM.01uFS	C4042	SM661207103	SM.01uFS
C3522	SM661207103	SM.01uFS	C4043	SM661207103	SM.01uFS
C3523	SM661207103	SM.01uFS	C4044	SM661207103	SM.01uFS
C3524	SM661207103	SM.01uFS	C4045	SM661207103	SM.01uFS
C3525	SM661207103	SM.01uFS	C4046	SM661207103	SM.01uFS
C4000	SM661207104	SM.1uFS	C4047	SM661207103	SM.01uFS
C4001	SM661207103	SM.01uFS	C4048	SM661207103	SM.01uFS
C4002	SM661207103	SM.01uFS	C4049	SM661207103	SM.01uFS
C4003	SM661127104	SM.1uF	C4050	SM661207103	SM.01uFS
C4004	SM661207104	SM.1uFS	C4051	SM661207103	SM.01uFS
C4005	SM661255056	SM5.6pFS	C4052	SM666327225	SM2.2uF-20V
C4006	SM661207103	SM.01uFS	C4053	SM666327225	SM2.2uF-20V
C4007	SM661207103	SM.01uFS	C4054	SM666327225	SM2.2uF-20V
C4008	SM661127104	SM.1uF	C4055	SM666327225	SM2.2uF-20V
C4009	158849012	5-15pF-S	C4056	SM666327225	SM2.2uF-20V
C4010	SM661256120	SM12pFS	C4057	SM661255181	SM180pFS
C4011	SM661255056	SM5.6pFS	C4058	SM661255270	SM27pFS
C4012	SM661255820	SM82pFS	C4059	SM661207103	SM.01uFS
C4013	SM661207103	SM.01uFS	C4500	SM661207103	SM.01uFS
C4014	SM661495561	SM560pFS-500V	C4501	SM661207103	SM.01uFS
C4015	SM661127104	SM.1uF	C4502	SM661207103	SM.01uFS
C4016	SM661207103	SM.01uFS	C4503	SM661207103	SM.01uFS
C4017	SM661207103	SM.01uFS	C4504	SM661207103	SM.01uFS
C4018	SM661207103	SM.01uFS	C4505	SM661207103	SM.01uFS
C4019	SM661207223	SM.022uFS	C4506	SM661207103	SM.01uFS
C4020	SM661207103	SM.01uFS	C4507	SM661207103	SM.01uFS
C4021	SM661207103	SM.01uFS	C4510	SM666237476	SM47uF-6V
C4022	SM661127104	SM.1uF	C4511	SM661207103	SM.01uFS
C4023	SM661207103	SM.01uFS	C4512	SM661207103	SM.01uFS

PART: F9314A-3 DESC: MAIN CARD (FRONT END, ADC, TDC) FOR 9314A/M/L

Location	Part Number	Description	Location	Part Number	Description
C4513	SM661207103	SM.01uFS	C5034	SM661207103	SM.01uFS
C4514	SM661207103	SM.01uFS	C5035	SM661207103	SM.01uFS
C4515	SM661207103	SM.01uFS	C5036	SM661207103	SM.01uFS
C4516	SM661207103	SM.01uFS	C5037	SM661207103	SM.01uFS
C4517	SM661207103	SM.01uFS	C5038	SM661207103	SM.01uFS
C4518	SM661207103	SM.01uFS	C5039	SM661207103	SM.01uFS
C4519	SM661207103	SM.01uFS	C5040	SM661207103	SM.01uFS
C4520	SM661207103	SM.01uFS	C5041	SM666327225	SM2.2uF-20V
C4521	SM661207103	SM.01uFS	C5042	SM661207103	SM.01uFS
C4522	SM661207103	SM.01uFS	C5043	SM661207103	SM.01uFS
C4523	SM661207103	SM.01uFS	C5044	SM661207103	SM.01uFS
C4524	SM661207103	SM.01uFS	C5045	SM661207103	SM.01uFS
C4525	SM661207103	SM.01uFS	C5046	SM661127104	SM.1uF
C5000	SM661207103	SM.01uFS	C5047	SM661255821	SM820pFS
C5001	SM661207104	SM.1uFS	C5048	SM661127104	SM.1uF
C5002	SM661250047	SM4.7pFS	C5049	SM661255100	SM10pFS
C5003	SM661207104	SM.1uFS	C5050	SM666327225	SM2.2uF-20V
C5004	SM661255027	SM2.7pFS	C5051	SM666327225	SM2.2uF-20V
C5005	SM661207103	SM.01uFS	C5052	SM661207103	SM.01uFS
C5006	SM661207103	SM.01uFS	C5053	SM661207103	SM.01uFS
C5007	SM661255033	SM3.3pFS	C5054	SM666327225	SM2.2uF-20V
C5008	SM661207103	SM.01uFS	C5055	SM666327225	SM2.2uF-20V
C5009	SM661495561	SM560pFS-500V	C5056	146554476	47uF-25V
C5010	SM661255022	SM2.2pFS	C5058	SM661207103	SM.01uFS
C5011	SM661207103	SM.01uFS	C5059	SM661207103	SM.01uFS
C5012	SM661207103	SM.01uFS	C5060	SM661127104	SM.1uF
C5013	SM661255470	SM47pFS	C5061	SM661127104	SM.1uF
C5014	SM661250082	SM8.2pFS	C6000	SM661207103	SM.01uFS
C5015	SM661207103	SM.01uFS	C6001	SM661207103	SM.01uFS
C5016	SM661207103	SM.01uFS	C6002	SM666327225	SM2.2uF-20V
C5019	SM661207103	SM.01uFS	C6003	SM666327225	SM2.2uF-20V
C5020	SM661207103	SM.01uFS	C6006	SM661255056	SM5.6pFS
C5021	SM661207103	SM.01uFS	C6050	SM661207104	SM.1uFS
C5022	SM661207103	SM.01uFS	C6051	SM661207104	SM.1uFS
C5023	SM661250082	SM8.2pFS	J1	454320096	3x32-ST-F
C5024	SM661250082	SM8.2pFS	J2	454110010	POWER1x10-M
C5025	SM666427105	SM1uF-16V	J3	454390002	1x2-ST-M-PL
C5026	SM661207103	SM.01uFS	J4	454115014	1x14-ST-M
C5027	SM661205822	SM.0082uFS	J1000	7093XXP01-P21	BNC PROBE
C5028	SM661207103	SM.01uFS	J2000	7093XXP01-P21	BNC PROBE
C5029	SM666427105	SM1uF-16V	J3000	7093XXP01-P21	BNC PROBE
C5030	SM661207103	SM.01uFS	J4000	7093XXP01-P21	BNC PROBE
C5031	SM661205822	SM.0082uFS	J5000	7093XXP01-P21	BNC PROBE
C5032	SM661207103	SM.01uFS	J6000	7093XXP01-P21	BNC PROBE
C5033	SM661207103	SM.01uFS	L101	SM301502001	SMBEAD1206

PART: F9314A-3 DESC: MAIN CARD (FRONT END, ADC, TDC) FOR 9314A/M/L

Location	Part Number	Description	Location	Part Number	Description
-----	-----	-----	-----	-----	-----
L104	SM301502001	SMBEAD1206	L6001	SM301502001	SMBEAD1206
L105	SM301502001	SMBEAD1206	Q402	SM270130092	BFR92A
L106	SM301502001	SMBEAD1206	Q403	SM270130092	BFR92A
L107	SM301502001	SMBEAD1206	Q404	SM270140092	BFR92AR
L110	SM301502001	SMBEAD1206	Q405	SM275030092	BFT92
L111	SM301502001	SMBEAD1206	Q406	SM275030092	BFT92
L200	SM301502001	SMBEAD1206	Q407	SM275030092	BFT92
L201	SM301502001	SMBEAD1206	Q408	SM275330858	BC858C
L202	SM301502001	SMBEAD1206	Q409	SM207130025	BFT25A
L203	SM301502001	SMBEAD1206	Q410	SM275330858	BC858C
L400	SM300446150	SM.015uH	Q411	SM270030020	BFS20
L401	SM300546151	SM.15uH	Q412	SM275030092	BFT92
L1000	SM300486104	SM100uH	Q1000	SM280120416	MMBF4416
L1001	SM301502001	SMBEAD1206	Q1001	SM270130092	BFR92A
L1002	SM301502001	SMBEAD1206	Q1002	SM270130092	BFR92A
L1003	SM301502001	SMBEAD1206	Q1003	SM289240062	BCV62
L1004	SM301502001	SMBEAD1206	Q1004	SM275040093	BFT93R
L1005	SM301502001	SMBEAD1206	Q1005	SM275030093	BFT93
L1500	SM301502001	SMBEAD1206	Q1006	SM270130092	BFR92A
L2000	SM300486104	SM100uH	Q1007	SM275330858	BC858C
L2001	SM301502001	SMBEAD1206	Q1008	SM275030092	BFT92
L2002	SM301502001	SMBEAD1206	Q1009	SM275030092	BFT92
L2003	SM301502001	SMBEAD1206	Q1010	SM275030092	BFT92
L2004	SM301502001	SMBEAD1206	Q1011	SM270130092	BFR92A
L2005	SM301502001	SMBEAD1206	Q1012	SM270130092	BFR92A
L2500	SM301502001	SMBEAD1206	Q1500	SM275330858	BC858C
L3000	SM300486104	SM100uH	Q1501	SM270330848	BC848C
L3001	SM301502001	SMBEAD1206	Q2000	SM280120416	MMBF4416
L3002	SM301502001	SMBEAD1206	Q2001	SM270130092	BFR92A
L3003	SM301502001	SMBEAD1206	Q2002	SM270130092	BFR92A
L3004	SM301502001	SMBEAD1206	Q2003	SM289240062	BCV62
L3005	SM301502001	SMBEAD1206	Q2004	SM275040093	BFT93R
L3500	SM301502001	SMBEAD1206	Q2005	SM275030093	BFT93
L4000	SM300486104	SM100uH	Q2006	SM270130092	BFR92A
L4001	SM301502001	SMBEAD1206	Q2007	SM275330858	BC858C
L4002	SM301502001	SMBEAD1206	Q2008	SM275030092	BFT92
L4003	SM301502001	SMBEAD1206	Q2009	SM275030092	BFT92
L4004	SM301502001	SMBEAD1206	Q2010	SM275030092	BFT92
L4005	SM301502001	SMBEAD1206	Q2011	SM270130092	BFR92A
L4500	SM301502001	SMBEAD1206	Q2012	SM270130092	BFR92A
L5000	SM301502001	SMBEAD1206	Q2500	SM275330858	BC858C
L5001	SM301502001	SMBEAD1206	Q2501	SM270330848	BC848C
L5002	SM301502001	SMBEAD1206	Q3000	SM280120416	MMBF4416
L5003	SM301502001	SMBEAD1206	Q3001	SM270130092	BFR92A
L6000	SM301502001	SMBEAD1206	Q3002	SM270130092	BFR92A

PART: F9314A-3 DESC: MAIN CARD (FRONT END, ADC, TDC) FOR 9314A/M/L

Location	Part Number	Description	Location	Part Number	Description
-----	-----	-----	-----	-----	-----
Q3003	SM289240062	BCV62	R11	SM652101103	SM10KS
Q3004	SM275040093	BFT93R	R12	SM652101103	SM10KS
Q3005	SM275030093	BFT93	R14	SM652101103	SM10KS
Q3006	SM270130092	BFR92A	R15	161445100	10-1/2W
Q3007	SM275330858	BC858C	R16	NOPOT	NOPOT-12T
Q3008	SM275030092	BFT92	R17	NOPOT	NOPOT-12T
Q3009	SM275030092	BFT92	R19	SM652101103	SM10KS
Q3010	SM275030092	BFT92	R20	SM652101103	SM10KS
Q3011	SM270130092	BFR92A	R25	SM652101220	SM22S
Q3012	SM270130092	BFR92A	R26	SM652101220	SM22S
Q3500	SM275330858	BC858C	R27	SM652101220	SM22S
Q3501	SM270330848	BC848C	R32	SM652101750	SM75S
Q4000	SM280120416	MMBF4416	R33	SM652101680	SM68S
Q4001	SM270130092	BFR92A	R34	SM652101680	SM68S
Q4002	SM270130092	BFR92A	R35	SM652101680	SM68S
Q4003	SM289240062	BCV62	R36	SM652101181	SM180S
Q4004	SM275040093	BFT93R	R37	SM652101181	SM180S
Q4005	SM275030093	BFT93	R38	SM652101220	SM22S
Q4006	SM270130092	BFR92A	R40	SM652101102	SM1KS
Q4007	SM275330858	BC858C	R41	SM652101271	SM270S
Q4008	SM275030092	BFT92	R60	SM652101332	SM3.3KS
Q4009	SM275030092	BFT92	R61	SM652101332	SM3.3KS
Q4010	SM275030092	BFT92	R62	SM652101332	SM3.3KS
Q4011	SM270130092	BFR92A	R63	SM652101332	SM3.3KS
Q4012	SM270130092	BFR92A	R64	SM652101332	SM3.3KS
Q4500	SM275330858	BC858C	R65	SM652101332	SM3.3KS
Q4501	SM270330848	BC848C	R66	SM652101103	SM10KS
Q5000	SM270130092	BFR92A	R68	SM654101000	SM0S
Q5001	SM280120416	MMBF4416	R69	SM652101102	SM1KS
Q5002	SM270130093	BFR93A	R72	SM652101100	SM10S
Q5003	SM270130092	BFR92A	R73	SM652101122	SM1.2KS
Q6000	SM270130093	BFR93A	R74	SM652101102	SM1KS
Q6001	SM270130093	BFR93A	R100	SM652101103	SM10KS
Q6002	SM275030550	BF550	R101	SM652101103	SM10KS
Q6003	SM270130092	BFR92A	R102	SM652101103	SM10KS
Q6005	SM275030550	BF550	R103	SM652101103	SM10KS
R1	SM652101223	SM22KS	R104	SM652101103	SM10KS
R2	169416473	NTC-DISC-47K	R105	SM652101103	SM10KS
R3	SM652101302	SM3KS	R106	SM652101103	SM10KS
R4	SM652101103	SM10KS	R107	SM652101103	SM10KS
R5	SM652101512	SM5.1KS	R108	SM652101103	SM10KS
R6	SM652101102	SM1KS	R109	SM652101103	SM10KS
R8	SM652101102	SM1KS	R110	SM652101103	SM10KS
R9	SM652101102	SM1KS	R111	SM652101103	SM10KS
R10	SM652101103	SM10KS	R112	SM652101301	SM300S

PART: F9314A-3 DESC: MAIN CARD (FRONT END, ADC, TDC) FOR 9314A/M/L

Location	Part Number	Description	Location	Part Number	Description
-----	-----	-----	-----	-----	-----
R113	SM652101510	SM51S	R430	SM652101562	SM5.6KS
R114	SM652101181	SM180S	R431	SM652101562	SM5.6KS
R115	SM652101103	SM10KS	R432	SM652101562	SM5.6KS
R116	SM168659007	SM3.0K-1/oo	R433	SM652101471	SM470S
R117	SM168659004	SM900-1/oo	R434	SM652101391	SM390S
R118	SM168659297	SM100-1/oo	R435	SM652101181	SM180S
R119	SM652101301	SM300S	R436	SM652101131	SM130S
R120	SM652101103	SM10KS	R437	SM652101471	SM470S
R121	SM652101181	SM180S	R438	SM652101750	SM75S
R130	SM652101103	SM10KS	R440	SM652101512	SM5.1KS
R131	SM652101824	SM820KS	R441	SM652101562	SM5.6KS
R132	SM652101102	SM1KS	R442	SM652101512	SM5.1KS
R133	SM652101153	SM15KS	R443	SM652101562	SM5.6KS
R134	SM652101332	SM3.3KS	R444	SM652101512	SM5.1KS
R135	SM652101152	SM1.5KS	R445	SM652101391	SM390S
R136	SM652101122	SM1.2KS	R446	SM652101562	SM5.6KS
R137	SM652101332	SM3.3KS	R447	SM652101181	SM180S
R200	SM652101391	SM390S	R448	SM652101820	SM82S
R400	SM652101680	SM68S	R449	SM652101131	SM130S
R401	SM652101271	SM270S	R450	SM652101471	SM470S
R402	SM652101680	SM68S	R452	SM652101512	SM5.1KS
R403	SM652101271	SM270S	R453	SM652101151	SM150S
R404	SM652101271	SM270S	R454	SM652101471	SM470S
R405	SM652101471	SM470S	R455	SM652101471	SM470S
R406	SM652101680	SM68S	R456	SM652101471	SM470S
R407	SM652101471	SM470S	R457	SM652101510	SM51S
R408	SM652101471	SM470S	R458	SM652101562	SM5.6KS
R409	SM652101680	SM68S	R459	SM652101512	SM5.1KS
R410	SM652101471	SM470S	R460	SM652101222	SM2.2KS
R411	SM652101271	SM270S	R461	SM652101391	SM390S
R412	SM652101271	SM270S	R462	SM652101471	SM470S
R413	SM652101471	SM470S	R463	SM652101471	SM470S
R414	SM652101680	SM68S	R464	SM652101392	SM3.9KS
R415	SM652101471	SM470S	R465	SM652101471	SM470S
R416	SM652101471	SM470S	R466	SM652101391	SM390S
R417	SM652101471	SM470S	R467	SM652101391	SM390S
R418	SM652101471	SM470S	R468	SM652101561	SM560S
R419	SM652101471	SM470S	R469	SM652101471	SM470S
R420	SM652101271	SM270S	R470	SM652101750	SM75S
R421	SM652101680	SM68S	R471	SM652101561	SM560S
R422	SM652101512	SM5.1KS	R472	SM652101151	SM150S
R423	SM652101512	SM5.1KS	R473	SM652101152	SM1.5KS
R424	SM652101512	SM5.1KS	R474	SM652101101	SM100S
R427	SM652101562	SM5.6KS	R475	SM652101101	SM100S
R429	SM652101471	SM470S	R476	SM652101750	SM75S

PART: F9314A-3 DESC: MAIN CARD (FRONT END, ADC, TDC) FOR 9314A/M/L

Location	Part Number	Description	Location	Part Number	Description
R477	SM652101151	SM150S	R535	SM652101392	SM3.9KS
R479	SM652101512	SM5.1KS	R536	SM651104151	SM150-25PPM
R480	SM652101241	SM240S	R537	SM652101152	SM1.5KS
R481	SM652101471	SM470S	R538	SM652101101	SM100S
R482	SM652101562	SM5.6KS	R539	SM652101131	SM130S
R483	SM652101512	SM5.1KS	R540	SM652101221	SM220S
R484	SM652101471	SM470S	R541	SM652101391	SM390S
R485	SM652101332	SM3.3KS	R542	SM652101680	SM68S
R486	SM652101510	SM51S	R543	SM651104392	SM3.9K-25PPM
R487	SM652101512	SM5.1KS	R544	SM651104204	SM200K-25PPM
R488	SM652101220	SM22S	R545	SM652101101	SM100S
R490	SM652101471	SM470S	R546	SM652101271	SM270S
R491	SM652101122	SM1.2KS	R547	SM652101391	SM390S
R492	SM652101220	SM22S	R548	SM651104182	SM1.8K-25PPM
R493	SM652101471	SM470S	R549	SM652101750	SM75S
R494	SM652101471	SM470S	R550	SM652101220	SM22S
R498	SM652101391	SM390S	R551	SM652101680	SM68S
R500	SM652101680	SM68S	R552	SM651104183	SM18K-25PPM
R501	SM652101391	SM390S	R553	SM652101751	SM750S
R502	SM652101680	SM68S	R554	SM652101680	SM68S
R503	SM652101680	SM68S	R555	SM652101510	SM51S
R505	SM652101471	SM470S	R556	SM652101510	SM51S
R506	SM652101391	SM390S	R557	SM652101751	SM750S
R507	SM652101241	SM240S	R558	SM652101471	SM470S
R508	SM652101471	SM470S	R559	SM652101510	SM51S
R511	SM652101391	SM390S	R561	SM652101391	SM390S
R514	SM652101471	SM470S	R562	SM652101510	SM51S
R515	SM652101910	SM91S	R563	SM652101301	SM300S
R516	SM652101680	SM68S	R564	SM652101220	SM22S
R517	SM651104391	SM390-25PPM	R565	SM652101391	SM390S
R518	SM185457101	SM100-1T	R566	SM652101751	SM750S
R519	SM652101751	SM750S	R567	SM652101103	SM10KS
R520	SM652101101	SM100S	R568	SM652101220	SM22S
R521	SM652101101	SM100S	R569	SM652101220	SM22S
R522	SM652101101	SM100S	R570	SM652101220	SM22S
R523	SM652101471	SM470S	R571	SM652101220	SM22S
R524	SM652101821	SM820S	R572	SM652101680	SM68S
R526	SM652101391	SM390S	R573	SM652101680	SM68S
R527	SM652101510	SM51S	R574	SM652101331	SM330S
R529	SM652101181	SM180S	R575	SM652101680	SM68S
R530	SM652101750	SM75S	R576	SM652101680	SM68S
R531	SM652101181	SM180S	R577	SM652101331	SM330S
R532	SM652101680	SM68S	R578	SM652101152	SM1.5KS
R533	SM652101680	SM68S	R579	SM652101103	SM10KS
R534	SM652101471	SM470S	R580	SM652101510	SM51S

PART: F9314A-3 DESC: MAIN CARD (FRONT END, ADC, TDC) FOR 9314A/M/L

Location	Part Number	Description	Location	Part Number	Description
R581	SM652101510	SM51S	R1008	SM168651297	'SM100-1%MM'
R582	SM652101152	SM1.5KS	R1009	SM652101822	SM8.2KS
R583	SM652101751	SM750S	R1010	SM652101683	SM68KS
R584	SM652101471	SM470S	R1011	SM185457203	SM20K-1T
R586	SM652101102	SM1KS	R1012	SM652101101	SM100S
R587	SM652101152	SM1.5KS	R1013	SM652101360	SM36S
R594	SM652101471	SM470S	R1014	SM652101330	SM33S
R601	SM652101220	SM22S	R1015	SM168651297	'SM100-1%MM'
R602	SM652101220	SM22S	R1016	SM652113523	SM52.63K-3/oo
R603	SM652101220	SM22S	R1017	SM652101101	SM100S
R604	SM652101220	SM22S	R1018	SM652101114	SM110KS
R609	SM652101102	SM1KS	R1019	SM652110904	SM900K-5/oo
R611	SM654101000	SM0S	R1020	SM652101272	SM2.7KS
R612	SM652101331	SM330S	R1021	SM652101512	SM5.1KS
R613	SM652101220	SM22S	R1022	SM652101101	SM100S
R614	SM652101911	SM910S	R1023	SM652101475	SM4.7MS
R618	SM652101102	SM1KS	R1024	SM652101122	SM1.2KS
R623	SM652101331	SM330S	R1025	SM652101221	SM220S
R624	SM652101103	SM10KS	R1026	SM652101105	SM1MS
R626	SM652101680	SM68S	R1027	SM652101105	SM1MS
R627	SM652101680	SM68S	R1028	SM652101390	SM39S
R650	SM652101102	SM1KS	R1029	SM652101151	SM150S
R653	SM652101512	SM5.1KS	R1030	SM652101512	SM5.1KS
R654	SM652101562	SM5.6KS	R1031	SM652101512	SM5.1KS
R655	SM652101471	SM470S	R1032	SM652101181	SM180S
R657	SM652101750	SM75S	R1033	SM652101185	SM1.8MS
R660	SM652101131	SM130S	R1034	SM652101334	SM330KS
R661	SM652101131	SM130S	R1035	SM652101101	SM100S
R662	SM652101680	SM68S	R1036	SM652101333	SM33KS
R663	SM652101680	SM68S	R1037	SM652101103	SM10KS
R664	SM652101131	SM130S	R1038	SM652101220	SM22S
R665	SM652101181	SM180S	R1039	SM652101511	SM510S
R666	SM652101680	SM68S	R1040	SM652101101	SM100S
R667	SM652101181	SM180S	R1041	SM185457103	SM10K-1T
R668	SM652101131	SM130S	R1042	SM652101103	SM10KS
R669	SM652101131	SM130S	R1043	SM652101913	SM91KS
R670	SM652101181	SM180S	R1044	SM652101100	SM10S
R1000	SM652101330	SM33S	R1045	SM652101100	SM10S
R1001	SM652101391	SM390S	R1046	SM652101100	SM10S
R1002	SM652101392	SM3.9KS	R1047	SM652101182	SM1.8KS
R1003	SM652101220	SM22S	R1048	SM652101163	SM16KS
R1004	SM652101105	SM1MS	R1049	SM652101122	SM1.2KS
R1005	SM652101332	SM3.3KS	R1050	SM652101101	SM100S
R1006	SM652113954	SM950K-3/oo	R1051	SM652101200	SM20S
R1007	SM652101181	SM180S	R1052	SM652101101	SM100S

PART: F9314A-3 DESC: MAIN CARD (FRONT END, ADC, TDC) FOR 9314A/M/L

Location	Part Number	Description	Location	Part Number	Description
R1053	SM652101223	SM22KS	R1506	SM652101182	SM1.8KS
R1054	SM652101240	SM24S	R1507	SM652101240	SM24S
R1055	SM652101240	SM24S	R1508	SM652101103	SM10KS
R1056	SM652101510	SM51S	R1509	SM652101100	SM10S
R1057	SM652101100	SM10S	R1510	SM652101122	SM1.2KS
R1058	SM652101100	SM10S	R1511	SM652101222	SM2.2KS
R1059	SM652101822	SM8.2KS	R1512	SM652101510	SM51S
R1060	SM652101471	SM470S	R1513	SM652101332	SM3.3KS
R1061	SM652101471	SM470S	R1514	SM652101332	SM3.3KS
R1062	SM652101152	SM1.5KS	R1515	SM652101332	SM3.3KS
R1063	SM652101101	SM100S	R1516	SM652101471	SM470S
R1064	SM652101750	SM75S	R1517	SM652101103	SM10KS
R1065	SM652101330	SM33S	R1518	SM652101392	SM3.9KS
R1066	SM652101301	SM300S	R1519	SM652101510	SM51S
R1067	SM652101101	SM100S	R1520	SM652101471	SM470S
R1068	SM652101302	SM3KS	R1521	SM652101272	SM2.7KS
R1069	SM652101152	SM1.5KS	R1522	SM652101103	SM10KS
R1070	SM652101202	SM2KS	R1523	SM185457103	SM10K-1T
R1071	SM652101103	SM10KS	R1524	SM652101273	SM27KS
R1072	SM652101391	SM390S	R1525	SM652101273	SM27KS
R1073	SM652101560	SM56S	R1526	SM185457102	SM1K-1T
R1074	SM652101560	SM56S	R1527	SM652101100	SM10S
R1075	SM652101560	SM56S	R1528	SM185457101	SM100-1T
R1076	SM652101562	SM5.6KS	R1530	SM652101333	SM33KS
R1077	SM652101152	SM1.5KS	R1531	SM185457104	SM100K-1T
R1078	SM652101221	SM220S	R2000	SM652101330	SM33S
R1079	SM185457203	SM20K-1T	R2001	SM652101391	SM390S
R1080	SM652101103	SM10KS	R2002	SM652101392	SM3.9KS
R1081	SM652101103	SM10KS	R2003	SM652101220	SM22S
R1082	SM652101103	SM10KS	R2004	SM652101105	SM1MS
R1083	SM652101221	SM220S	R2005	SM652101332	SM3.3KS
R1084	SM652101105	SM1MS	R2006	SM652113954	SM950K-3/oo
R1085	SM652101103	SM10KS	R2007	SM652101181	SM180S
R1086	SM652101105	SM1MS	R2008	SM168651297	'SM100-1%MM'
R1087	SM652101390	SM39S	R2009	SM652101822	SM8.2KS
R1088	SM653185390	SM39	R2010	SM652101683	SM68KS
R1089	SM652101100	SM10S	R2011	SM185457203	SM20K-1T
R1498	SM652101470	SM47S	R2012	SM652101101	SM100S
R1499	SM652101470	SM47S	R2013	SM652101360	SM36S
R1500	SM652101103	SM10KS	R2014	SM652101330	SM33S
R1501	SM185457102	SM1K-1T	R2015	SM168651297	'SM100-1%MM'
R1502	SM652101820	SM82S	R2016	SM652113523	SM52.63K-3/oo
R1503	SM652101240	SM24S	R2017	SM652101101	SM100S
R1504	SM652101390	SM39S	R2018	SM652101114	SM110KS
R1505	SM652101621	SM620S	R2019	SM652110904	SM900K-5/oo

PART: F9314A-3 DESC: MAIN CARD (FRONT END, ADC, TDC) FOR 9314A/M/L

Location	Part Number	Description	Location	Part Number	Description
-----	-----	-----	-----	-----	-----
R2020	SM652101272	SM2.7KS	R2065	SM652101330	SM33S
R2021	SM652101512	SM5.1KS	R2066	SM652101301	SM300S
R2022	SM652101101	SM100S	R2067	SM652101101	SM100S
R2023	SM652101475	SM4.7MS	R2068	SM652101302	SM3KS
R2024	SM652101122	SM1.2KS	R2069	SM652101152	SM1.5KS
R2025	SM652101221	SM220S	R2070	SM652101202	SM2KS
R2026	SM652101105	SM1MS	R2071	SM652101103	SM10KS
R2027	SM652101105	SM1MS	R2072	SM652101391	SM390S
R2028	SM652101390	SM39S	R2073	SM652101560	SM56S
R2029	SM652101151	SM150S	R2074	SM652101560	SM56S
R2030	SM652101512	SM5.1KS	R2075	SM652101560	SM56S
R2031	SM652101512	SM5.1KS	R2076	SM652101562	SM5.6KS
R2032	SM652101181	SM180S	R2077	SM652101152	SM1.5KS
R2033	SM652101185	SM1.8MS	R2078	SM652101221	SM220S
R2034	SM652101334	SM330KS	R2079	SM185457203	SM20K-1T
R2035	SM652101101	SM100S	R2080	SM652101103	SM10KS
R2036	SM652101333	SM33KS	R2081	SM652101103	SM10KS
R2037	SM652101103	SM10KS	R2082	SM652101103	SM10KS
R2038	SM652101220	SM22S	R2083	SM652101221	SM220S
R2039	SM652101511	SM510S	R2084	SM652101105	SM1MS
R2040	SM652101101	SM100S	R2085	SM652101103	SM10KS
R2041	SM185457103	SM10K-1T	R2086	SM652101105	SM1MS
R2042	SM652101103	SM10KS	R2087	SM652101390	SM39S
R2043	SM652101913	SM91KS	R2088	SM653185390	SM39
R2044	SM652101100	SM10S	R2089	SM652101100	SM10S
R2045	SM652101100	SM10S	R2500	SM652101103	SM10KS
R2046	SM652101100	SM10S	R2501	SM185457102	SM1K-1T
R2047	SM652101182	SM1.8KS	R2502	SM652101820	SM82S
R2048	SM652101163	SM16KS	R2503	SM652101240	SM24S
R2049	SM652101122	SM1.2KS	R2504	SM652101390	SM39S
R2050	SM652101101	SM100S	R2505	SM652101621	SM620S
R2051	SM652101200	SM20S	R2506	SM652101182	SM1.8KS
R2052	SM652101101	SM100S	R2507	SM652101240	SM24S
R2053	SM652101223	SM22KS	R2508	SM652101103	SM10KS
R2054	SM652101240	SM24S	R2509	SM652101100	SM10S
R2055	SM652101240	SM24S	R2510	SM652101122	SM1.2KS
R2056	SM652101510	SM51S	R2511	SM652101222	SM2.2KS
R2057	SM652101100	SM10S	R2512	SM652101510	SM51S
R2058	SM652101100	SM10S	R2513	SM652101332	SM3.3KS
R2059	SM652101822	SM8.2KS	R2514	SM652101332	SM3.3KS
R2060	SM652101471	SM470S	R2515	SM652101332	SM3.3KS
R2061	SM652101471	SM470S	R2516	SM652101471	SM470S
R2062	SM652101152	SM1.5KS	R2517	SM652101103	SM10KS
R2063	SM652101101	SM100S	R2518	SM652101392	SM3.9KS
R2064	SM652101750	SM75S	R2519	SM652101510	SM51S

PART: F9314A-3 DESC: MAIN CARD (FRONT END, ADC, TDC) FOR 9314A/M/L

Location	Part Number	Description	Location	Part Number	Description
R2520	SM652101471	SM470S	R3034	SM652101334	SM330KS
R2521	SM652101272	SM2.7KS	R3035	SM652101101	SM100S
R2522	SM652101103	SM10KS	R3036	SM652101333	SM33KS
R2523	SM185457103	SM10K-1T	R3037	SM652101103	SM10KS
R2524	SM652101273	SM27KS	R3038	SM652101220	SM22S
R2525	SM652101273	SM27KS	R3039	SM652101511	SM510S
R2526	SM185457102	SM1K-1T	R3040	SM652101101	SM100S
R2527	SM652101100	SM10S	R3041	SM185457103	SM10K-1T
R2528	SM185457101	SM100-1T	R3042	SM652101103	SM10KS
R2530	SM652101333	SM33KS	R3043	SM652101913	SM91KS
R2531	SM185457104	SM100K-1T	R3044	SM652101100	SM10S
R3000	SM652101330	SM33S	R3045	SM652101100	SM10S
R3001	SM652101391	SM390S	R3046	SM652101100	SM10S
R3002	SM652101392	SM3.9KS	R3047	SM652101182	SM1.8KS
R3003	SM652101220	SM22S	R3048	SM652101163	SM16KS
R3004	SM652101105	SM1MS	R3049	SM652101122	SM1.2KS
R3005	SM652101332	SM3.3KS	R3050	SM652101101	SM100S
R3006	SM652113954	SM950K-3/oo	R3051	SM652101200	SM20S
R3007	SM652101181	SM180S	R3052	SM652101101	SM100S
R3008	SM168651297	'SM100-1%MM'	R3053	SM652101223	SM22KS
R3009	SM652101822	SM8.2KS	R3054	SM652101240	SM24S
R3010	SM652101683	SM68KS	R3055	SM652101240	SM24S
R3011	SM185457203	SM20K-1T	R3056	SM652101510	SM51S
R3012	SM652101101	SM100S	R3057	SM652101100	SM10S
R3013	SM652101360	SM36S	R3058	SM652101100	SM10S
R3014	SM652101330	SM33S	R3059	SM652101822	SM8.2KS
R3015	SM168651297	'SM100-1%MM'	R3060	SM652101471	SM470S
R3016	SM652113523	SM52.63K-3/oo	R3061	SM652101471	SM470S
R3017	SM652101101	SM100S	R3062	SM652101152	SM1.5KS
R3018	SM652101114	SM110KS	R3063	SM652101101	SM100S
R3019	SM652110904	SM900K-5/oo	R3064	SM652101750	SM75S
R3020	SM652101272	SM2.7KS	R3065	SM652101330	SM33S
R3021	SM652101512	SM5.1KS	R3066	SM652101301	SM300S
R3022	SM652101101	SM100S	R3067	SM652101101	SM100S
R3023	SM652101475	SM4.7MS	R3068	SM652101302	SM3KS
R3024	SM652101122	SM1.2KS	R3069	SM652101152	SM1.5KS
R3025	SM652101221	SM220S	R3070	SM652101202	SM2KS
R3026	SM652101105	SM1MS	R3071	SM652101103	SM10KS
R3027	SM652101105	SM1MS	R3072	SM652101391	SM390S
R3028	SM652101390	SM39S	R3073	SM652101560	SM56S
R3029	SM652101151	SM150S	R3074	SM652101560	SM56S
R3030	SM652101512	SM5.1KS	R3075	SM652101560	SM56S
R3031	SM652101512	SM5.1KS	R3076	SM652101562	SM5.6KS
R3032	SM652101181	SM180S	R3077	SM652101152	SM1.5KS
R3033	SM652101185	SM1.8MS	R3078	SM652101221	SM220S

PART: F9314A-3 DESC: MAIN CARD (FRONT END, ADC, TDC) FOR 9314A/M/L

Location	Part Number	Description	Location	Part Number	Description
R3079	SM185457203	SM20K-1T	R4003	SM652101220	SM22S
R3080	SM652101103	SM10KS	R4004	SM652101105	SM1MS
R3081	SM652101103	SM10KS	R4005	SM652101332	SM3.3KS
R3082	SM652101103	SM10KS	R4006	SM652113954	SM950K-3/oo
R3083	SM652101221	SM220S	R4007	SM652101181	SM180S
R3084	SM652101105	SM1MS	R4008	SM168651297	'SM100-1%MM'
R3085	SM652101103	SM10KS	R4009	SM652101822	SM8.2KS
R3086	SM652101105	SM1MS	R4010	SM652101683	SM68KS
R3087	SM652101390	SM39S	R4011	SM185457203	SM20K-1T
R3088	SM653185390	SM39	R4012	SM652101101	SM100S
R3089	SM652101100	SM10S	R4013	SM652101360	SM36S
R3500	SM652101103	SM10KS	R4014	SM652101330	SM33S
R3501	SM185457102	SM1K-1T	R4015	SM168651297	'SM100-1%MM'
R3502	SM652101820	SM82S	R4016	SM652113523	SM52.63K-3/oo
R3503	SM652101240	SM24S	R4017	SM652101101	SM100S
R3504	SM652101390	SM39S	R4018	SM652101114	SM110KS
R3505	SM652101621	SM620S	R4019	SM652110904	SM900K-5/oo
R3506	SM652101182	SM1.8KS	R4020	SM652101272	SM2.7KS
R3507	SM652101240	SM24S	R4021	SM652101512	SM5.1KS
R3508	SM652101103	SM10KS	R4022	SM652101101	SM100S
R3509	SM652101100	SM10S	R4023	SM652101475	SM4.7MS
R3510	SM652101122	SM1.2KS	R4024	SM652101122	SM1.2KS
R3511	SM652101222	SM2.2KS	R4025	SM652101221	SM220S
R3512	SM652101510	SM51S	R4026	SM652101105	SM1MS
R3513	SM652101332	SM3.3KS	R4027	SM652101105	SM1MS
R3514	SM652101332	SM3.3KS	R4028	SM652101390	SM39S
R3515	SM652101332	SM3.3KS	R4029	SM652101151	SM150S
R3516	SM652101471	SM470S	R4030	SM652101512	SM5.1KS
R3517	SM652101103	SM10KS	R4031	SM652101512	SM5.1KS
R3518	SM652101392	SM3.9KS	R4032	SM652101181	SM180S
R3519	SM652101510	SM51S	R4033	SM652101185	SM1.8MS
R3520	SM652101471	SM470S	R4034	SM652101334	SM330KS
R3521	SM652101272	SM2.7KS	R4035	SM652101101	SM100S
R3522	SM652101103	SM10KS	R4036	SM652101333	SM33KS
R3523	SM185457103	SM10K-1T	R4037	SM652101103	SM10KS
R3524	SM652101273	SM27KS	R4038	SM652101220	SM22S
R3525	SM652101273	SM27KS	R4039	SM652101511	SM510S
R3526	SM185457102	SM1K-1T	R4040	SM652101101	SM100S
R3527	SM652101100	SM10S	R4041	SM185457103	SM10K-1T
R3528	SM185457101	SM100-1T	R4042	SM652101103	SM10KS
R3530	SM652101333	SM33KS	R4043	SM652101913	SM91KS
R3531	SM185457104	SM100K-1T	R4044	SM652101100	SM10S
R4000	SM652101330	SM33S	R4045	SM652101100	SM10S
R4001	SM652101391	SM390S	R4046	SM652101100	SM10S
R4002	SM652101392	SM3.9KS	R4047	SM652101182	SM1.8KS

PART: F9314A-3 DESC: MAIN CARD (FRONT END, ADC, TDC) FOR 9314A/M/L

Location	Part Number	Description	Location	Part Number	Description
R4048	SM652101163	SM16KS	R4503	SM652101240	SM24S
R4049	SM652101122	SM1.2KS	R4504	SM652101390	SM39S
R4050	SM652101101	SM100S	R4505	SM652101621	SM620S
R4051	SM652101200	SM20S	R4506	SM652101182	SM1.8KS
R4052	SM652101101	SM100S	R4507	SM652101240	SM24S
R4053	SM652101223	SM22KS	R4508	SM652101103	SM10KS
R4054	SM652101240	SM24S	R4509	SM652101100	SM10S
R4055	SM652101240	SM24S	R4510	SM652101122	SM1.2KS
R4056	SM652101510	SM51S	R4511	SM652101222	SM2.2KS
R4057	SM652101100	SM10S	R4512	SM652101510	SM51S
R4058	SM652101100	SM10S	R4513	SM652101332	SM3.3KS
R4059	SM652101822	SM8.2KS	R4514	SM652101332	SM3.3KS
R4060	SM652101471	SM470S	R4515	SM652101332	SM3.3KS
R4061	SM652101471	SM470S	R4516	SM652101471	SM470S
R4062	SM652101152	SM1.5KS	R4517	SM652101103	SM10KS
R4063	SM652101101	SM100S	R4518	SM652101392	SM3.9KS
R4064	SM652101750	SM75S	R4519	SM652101510	SM51S
R4065	SM652101330	SM33S	R4520	SM652101471	SM470S
R4066	SM652101301	SM300S	R4521	SM652101272	SM2.7KS
R4067	SM652101101	SM100S	R4522	SM652101103	SM10KS
R4068	SM652101302	SM3KS	R4523	SM185457103	SM10K-1T
R4069	SM652101152	SM1.5KS	R4524	SM652101273	SM27KS
R4070	SM652101202	SM2KS	R4525	SM652101273	SM27KS
R4071	SM652101103	SM10KS	R4526	SM185457102	SM1K-1T
R4072	SM652101391	SM390S	R4527	SM652101100	SM10S
R4073	SM652101560	SM56S	R4528	SM185457101	SM100-1T
R4074	SM652101560	SM56S	R4530	SM652101333	SM33KS
R4075	SM652101560	SM56S	R4531	SM185457104	SM100K-1T
R4076	SM652101562	SM5.6KS	R5000	SM652101330	SM33S
R4077	SM652101152	SM1.5KS	R5001	SM652101220	SM22S
R4078	SM652101221	SM220S	R5002	SM652101220	SM22S
R4079	SM185457203	SM20K-1T	R5003	SM168651297	'SM100-1%MM'
R4080	SM652101103	SM10KS	R5004	SM652101272	SM2.7KS
R4081	SM652101103	SM10KS	R5005	SM652101220	SM22S
R4082	SM652101103	SM10KS	R5006	SM652101202	SM2KS
R4083	SM652101221	SM220S	R5007	SM168651297	'SM100-1%MM'
R4084	SM652101105	SM1MS	R5008	SM652101330	SM33S
R4085	SM652101103	SM10KS	R5009	SM652101104	SM100KS
R4086	SM652101105	SM1MS	R5010	SM652110904	SM900K-5/oo
R4087	SM652101390	SM39S	R5011	SM652101122	SM1.2KS
R4088	SM653185390	SM39	R5012	SM652101221	SM220S
R4089	SM652101100	SM10S	R5013	SM652101391	SM390S
R4500	SM652101103	SM10KS	R5014	SM652101123	SM12KS
R4501	SM185457102	SM1K-1T	R5015	SM652101151	SM150S
R4502	SM652101820	SM82S	R5016	SM652101475	SM4.7MS

PART: F9314A-3 DESC: MAIN CARD (FRONT END, ADC, TDC) FOR 9314A/M/L

Location	Part Number	Description	Location	Part Number	Description
R5017	SM652110904	SM900K-5/oo	R5066	SM652101222	SM2.2KS
R5018	SM652101510	SM51S	R5067	SM652101153	SM15KS
R5019	SM652101104	SM100KS	R5068	SM652101222	SM2.2KS
R5020	SM168659006	SM111.1K-1/oo	R5069	SM652101822	SM8.2KS
R5021	SM652101103	SM10KS	R5070	SM652101332	SM3.3KS
R5022	SM652101181	SM180S	R5071	SM652101512	SM5.1KS
R5023	SM652110904	SM900K-5/oo	R5072	SM652101512	SM5.1KS
R5024	SM652101561	SM560S	R5073	SM652101512	SM5.1KS
R5025	SM652101100	SM10S	R5074	SM652101105	SM1MS
R5026	SM652101560	SM56S	R5075	SM652101392	SM3.9KS
R5027	SM652101561	SM560S	R5076	SM652101683	SM68KS
R5028	SM652101331	SM330S	R5077	SM185457103	SM10K-1T
R5029	SM652101101	SM100S	R6000	SM652101112	SM1.1KS
R5030	SM652101101	SM100S	R6001	SM652101112	SM1.1KS
R5032	SM652101391	SM390S	R6002	SM652101391	SM390S
R5034	SM652101471	SM470S	R6003	SM652101112	SM1.1KS
R5035	SM652101222	SM2.2KS	R6004	SM652101331	SM330S
R5037	SM652101560	SM56S	R6005	SM168659297	SM100-1/oo
R5038	SM652101222	SM2.2KS	R6006	SM168659297	SM100-1/oo
R5040	SM652101391	SM390S	R6008	SM168659297	SM100-1/oo
R5041	SM652101391	SM390S	R6009	SM168659004	SM900-1/oo
R5042	SM652101332	SM3.3KS	R6012	SM168659007	SM3.0K-1/oo
R5043	SM652101750	SM75S	R6013	SM652101512	SM5.1KS
R5044	SM652101750	SM75S	R6014	SM168659007	SM3.0K-1/oo
R5045	SM652101391	SM390S	R6015	SM168659007	SM3.0K-1/oo
R5046	SM652101332	SM3.3KS	R6016	SM168659007	SM3.0K-1/oo
R5047	SM652101163	SM16KS	R6017	SM652101131	SM130S
R5048	SM652101332	SM3.3KS	R6018	SM652101181	SM180S
R5049	SM652101750	SM75S	R6019	SM652101512	SM5.1KS
R5050	SM652101750	SM75S	R6020	SM652101511	SM510S
R5051	SM652101391	SM390S	R6021	SM652101101	SM100S
R5052	SM652101332	SM3.3KS	R6050	SM652101330	SM33S
R5053	SM652101163	SM16KS	R6051	SM652101330	SM33S
R5054	SM185457203	SM20K-1T	R6052	SM652101330	SM33S
R5055	SM652101561	SM560S	R6060	SM652101512	SM5.1KS
R5056	SM185457203	SM20K-1T	S50	SM654101000	SM0S-2P
R5057	SM652101561	SM560S	S200	SM654101000	SM0S-2P
R5058	SM652101512	SM5.1KS	S201	SM654101000	SM0S-2P
R5059	SM652101512	SM5.1KS	S202	SM654101000	SM0S-2P
R5060	SM652101474	SM470KS	S203	SM654101000	SM0S-2P
R5061	SM652101824	SM820KS	Y400	310062100	100MHZ
R5062	SM652101684	SM680KS	BZ400	530040006	HMB-06
R5063	SM652101181	SM180S	CR50	SM236030099	BAV99
R5064	SM652101153	SM15KS	CR100	SM240218475	BZX84-C7V5
R5065	SM652101222	SM2.2KS	CR101	SM240218475	BZX84-C7V5

PART: F9314A-3 DESC: MAIN CARD (FRONT END, ADC, TDC) FOR 9314A/M/L

Location	Part Number	Description	Location	Part Number	Description
CR102	SM240218451	BZX84-C5V1	CR6003	SM240050051	TZMC5V1
CR402	SM236654004	SM4004	CR6050	SM236030099	BAV99
CR403	SM236030099	BAV99	CR6051	SM229020150	SMTVSS-5V6
CR404	SM252080682	BA682	DL400	290120004	4nS
CR405	SM252080682	BA682	DL401	290120004	4nS
CR406	SM252080682	BA682	RL1000	430441732	RL-732-12
CR407	SM252080682	BA682	RL1001	430430002	RL-FBR22-12
CR408	SM252080682	BA682	RL1002	430441732	RL-732-12
CR411	SM232022822	HSMS2822	RL1003	430430002	RL-FBR22-12
CR1000	SM229020150	SMTVSS-5V6	RL2000	430441732	RL-732-12
CR1001	SM236030099	BAV99	RL2001	430430002	RL-FBR22-12
CR1002	SM236030099	BAV99	RL2002	430441732	RL-732-12
CR1003	SM236030099	BAV99	RL2003	430430002	RL-FBR22-12
CR1004	SM252023018	BAT18	RL3000	430441732	RL-732-12
CR1005	SM240050051	TZMC5V1	RL3001	430430002	RL-FBR22-12
CR2000	SM229020150	SMTVSS-5V6	RL3002	430441732	RL-732-12
CR2001	SM236030099	BAV99	RL3003	430430002	RL-FBR22-12
CR2002	SM236030099	BAV99	RL4000	430441732	RL-732-12
CR2003	SM236030099	BAV99	RL4001	430430002	RL-FBR22-12
CR2004	SM252023018	BAT18	RL4002	430441732	RL-732-12
CR2005	SM240050051	TZMC5V1	RL4003	430430002	RL-FBR22-12
CR3000	SM229020150	SMTVSS-5V6	RL5000	430490003	RL-TQ2-12
CR3001	SM236030099	BAV99	RL5001	430430002	RL-FBR22-12
CR3002	SM236030099	BAV99	RL5002	430490003	RL-TQ2-12
CR3003	SM236030099	BAV99	RL5003	430490003	RL-TQ2-12
CR3004	SM252023018	BAT18	RN2	190042103	10K-SIPC
CR3005	SM240050051	TZMC5V1	RN3	190042103	10K-SIPC
CR4000	SM229020150	SMTVSS-5V6	RN4	190042103	10K-SIPC
CR4001	SM236030099	BAV99	RN5	190042103	10K-SIPC
CR4002	SM236030099	BAV99	RN6	190042103	10K-SIPC
CR4003	SM236030099	BAV99	RN7	190042103	10K-SIPC
CR4004	SM252023018	BAT18	RN50	190042103	10K-SIPC
CR4005	SM240050051	TZMC5V1	RN400	190642221	220-6SIPC
CR5000	SM229020150	SMTVSS-5V6	RN401	190642221	220-6SIPC
CR5001	SM236030099	BAV99	RN1500	190042471	470-SC
CR5002	SM252023018	BAT18	RN2500	190042471	470-SC
CR5003	SM232120070	BAV70	RN3500	190042471	470-SC
CR5004	SM232120070	BAV70	RN4500	190042471	470-SC
CR5005	SM232120070	BAV70	TP100	454313010	2x5-ST-M
CR5006	SM240050033	TZMC3V3	TP101	454313010	2x5-ST-M
CR5007	SM240050033	TZMC3V3	TP200	454313010	2x5-ST-M
CR5008	SM236030099	BAV99	TP1000	454340002	2x1-ST-M-NW
CR5009	SM236030099	BAV99	TP1500	454315008	2x4-ST-M-NW
CR6000	SM253032823	HSMS2823	TP2000	454340002	2x1-ST-M-NW
CR6001	SM232022822	HSMS2822	TP2500	454315008	2x4-ST-M-NW

PART: F9314A-3 DESC: MAIN CARD (FRONT END, ADC, TDC) FOR 9314A/M/L

Location	Part Number	Description
-----	-----	-----
TP3000	454340002	2x1-ST-M-NW
TP3500	454315008	2x4-ST-M-NW
TP4000	454340002	2x1-ST-M-NW
TP4500	454315008	2x4-ST-M-NW
TP5000	454340002	2x1-ST-M-NW

PART: F9314A-3 DESC: MAIN CARD (FRONT END, ADC, TDC) FOR 9314A

COMPONENT	PART DESCRIPTION	QTY PER ASSEMBLY
-----	-----	-----
205750000	IC AND-OR GATE ARRAY 16V8	5
MNX401	ICMIN MAX GATEARR. MNX401	1
S9314A-3	COMMON PARTS FOR 9314A-3	1
SM200248191	IC 4-BIT U/D CNTR 74HCT191	5
SM205219264	IC 8K X 8 SRAM 70 NSEC 6264	32
SM205290512	IC 512K X 8 PSRAM HM658512	2
SM652101181	RES CHIP (E24) 1% 180 OHM	18
SM652101221	RES CHIP (E24) 1% 220 OHM	14
SM661250082	CAP CERA CHIP .1% 8.2 PF	7
SM661255181	CAP CERA CHIP 5% 180 PF	5
SM661255270	CAP CERA CHIP 27PF	7
SM661255330	CAP CERA CHIP 5% 33 PF	1

PART: F9314AM-3 DESC: MAIN CARD (FRONT END, ADC, TDC) FOR 9314AM

COMPONENT	PART DESCRIPTION	QTY PER ASSEMBLY
-----	-----	-----
205750000	IC AND-OR GATE ARRAY 16V8	5
MNX401	ICMIN MAX GATEARR. MNX401	1
S9314A-3	COMMON PARTS FOR 9314A-3	1
SM200248191	IC 4-BIT U/D CNTR 74HCT191	5
SM205219256	IC 32K X 8 SRAM MS62256	32
SM205290512	IC 512K X 8 PSRAM HM658512	2
SM652101181	RES CHIP (E24) 1% 180 OHM	18
SM652101221	RES CHIP (E24) 1% 220 OHM	14
SM661250082	CAP CERA CHIP .1% 8.2 PF	7
SM661255181	CAP CERA CHIP 5% 180 PF	5
SM661255270	CAP CERA CHIP 27PF	7
SM661255330	CAP CERA CHIP 5% 33 PF	1

PART: F9314AL-3 DESC: MAIN CARD (FRONT END, ADC, TDC) FOR 9314AL

COMPONENT	PART DESCRIPTION	QTY PER ASSEMBLY
205750000	IC AND-OR GATE ARRAY 16V8	5
MNX401	ICMIN MAX GATEARR. MNX401	1
S9314A-3	COMMON PARTS FOR 9314A-3	1
SM200248191	IC 4-BIT U/D CNTR 74HCT191	5
SM205290512	IC 512K X 8 PSRAM HM658512	2
SM205701070	IC 128KX8 STAT RAM 70 NS	32
SM652101181	RES CHIP (E24) 1% 180 OHM	18
SM652101221	RES CHIP (E24) 1% 220 OHM	14
SM661250082	CAP CERA CHIP .1% 8.2 PF	7
SM661255181	CAP CERA CHIP 5% 180 PF	5
SM661255270	CAP CERA CHIP 27PF	7
SM661255330	CAP CERA CHIP 5% 33 PF	1

PART: S9314A-3 DESC: MAIN CARD (FRONT END, ADC, TDC) FOR 9314A/M/L

COMPONENT	PART DESCRIPTION	QTY PER ASSEMBLY
146544471	CAP MINI ALUM 20% 470UF	1
158849013	CAP VARIABLE 6-25 PF	4
158899002	CAP VARIABLE .2 - .6 PF	4
161225101	RES COMP 1/8W 5% 100 OHMS	4
161225680	RES COMP 1/8W 5% 68 OHMS	3
161445100	RES COMP 1/2W 5% 10 OHMS	1
169416473	RESISTOR DISC NTC 47 K	1
181447104	RES VARI CERMET 100 K	2
190042103	RESISTOR NETWORK 10 K	5
190042471	RESISTOR NETWORK 470 OHMS	4
190642103	RESISTOR NETWORK 10 K	1
190642221	RESISTOR NETWORK 220 OHMS	2
190642472	RESISTOR NETWORK 4.7 K	1
207200200	IC 8-BIT FLASH ADC 77200	4
207280703	IC 16-BIT DAC 703	1
208122002	IC VOLT REG POS UA7805	2
208123002	IC +12 VOLT REG LM340T-12	2
208124002	IC VOLT REG -5V UA7905UC	1
208124003	IC VOLT REG NEG LM320T-12	2
290120004	DELAY LINE 4 NS	2
310062100	CRYSTAL 10PPM 100MHZ	1
402110303	CONN PC MTG/THREAD BNC	6
403119004	HEADER RT ANGLE 4-PIN	1
430430002	RELAY 1 FORM C SPDT	8
430441732	RELAY 2 FORM CDPDT	8
430490003	RELAY 2 FORM C DPDT	3
454110010	HDR SOLD TAIL/MALE PIN 10	1
454313010	HDR DIP SOLD TO PCB 2X5	3

PART: S9314A-3 DESC: MAIN CARD (FRONT END, ADC, TDC) FOR 9314A/M/L

COMPONENT	PART DESCRIPTION	QTY PER ASSEMBLY
454315008	HDR DIP SOLD TO PCB 2X4	4
454320096	HDR DIP SOLD TO FEM 96	1
454340002	HDR MALE PIN TO WW 02	5
454390002	HDR FRICTION LOCK 2-PIN	1
550430105	SCREW CYL HD PHIL M3X5	12
550430706	SCREW ECO-FIX M3X6	12
554435401	RIVET "RIVSCREW" M 3.5	7
585252236	RIVET HOLLOW 2.5X6MM	2
709314321	M/CARD 9314-3 U/COVER SHIELD	1
709314331	MAIN CARD U/SEP SHIELD	6
7093XX331	MAIN CARD BNC SPACER	6
709450321	HEAT SINK FOR FADC	5
719314303	PC BD PREASS'Y 9314-3	1
CH599011061	ADHESIVE (THERMAL COND) 709	1
FP9314-3	MAIN CARD PANEL 9314-3	1
HSH410	HYB SAMPLE & HOLD HSH410	4
MCL404	IC MEM GATE ARRAY MCL404	1
MDX407	IC DEMULTIPLEXER MDX407	4
MFE409	MONOL. DSO FRONT END (500MHZ)	4
MST412	IC SMART TRIGGER GATE-ARRAY	1
MTB411	IC TIME BASE GATE-ARRAY	1
MTR408	TRIGGER COUPLING & COMPARATOR	2
SM158043006	CAP VARIABLE 2 - 6 PF	1
SM158240200	CAP VARIABLE .6 - 2.5 PF	1
SM168651297	RES METAL FILM 1% 100 OHMS	8
SM168659004	RES METAL FILM .1% 900 OHMS	1
SM168659006	RES METAL FILM .1% 111.1 K	1
SM168659007	RES METAL FILM .1% 3.00 K	1
SM168659297	RES METAL FILM .1% 100 OHMS	3
SM185457101	RES VARI CERMET 100 OHMS	1
SM185457102	RES VARI CERMET 1 K	8
SM185457103	RES VARI CERMET 10 K	8
SM185457203	RES VARI CERMET 20 K	10
SM200167102	IC NOR GATE 10H102	1
SM200167103	IC 2-INP OR GATE 10H103	1
SM200167105	IC 2-3-2 OR/NOR 10H105	4
SM200167121	IC OR-AND/O-A-INV 10H121	1
SM200167131	IC M-S TYP D FLOP 10H131	5
SM200176002	IC 2-IN NOR HC02	1
SM200178000	IC 2-INPUT NAND HCT00	1
SM200178002	IC 2-INPUT NOR HCT02	1
SM200178020	IC 4-IN NAND HCT20	1
SM200178074	IC D-TYP FLOP 74HCT74	1
SM200178138	IC 3-8 LINE DECOD HCT 138	3
SM200178139	IC 2-TO-4-LINE DEC HCT139	1

PART: S9314A-3 DESC: MAIN CARD (FRONT END, ADC, TDC) FOR 9314A/M/L

COMPONENT	PART DESCRIPTION	QTY PER ASSEMBLY
SM200178374	IC D-TYP FLOP 74HCT374	1
SM200179374	IC OCTAL D-TYP F-F 74BCT374	2
SM200267016	IC BINARY COUNTER 10H016	1
SM200278040	IC COUNTER HCT4040	1
SM201177000	IC 2-IN NAND 74ACT00	1
SM201177004	IC HEX INVERTER 74ACT04	1
SM201177008	IC 4X2 INPUT AND 74ACT08	2
SM201177109	IC DUAL FLPO 74ACT109	2
SM205617594	IC 8-BIT SHIFT REG 74HC594	12
SM205618165	IC 8-BIT SHIFT REG 74HCT165	1
SM206886623	IC OCTAL BUS TRANSCVR. BCT623	6
SM207130025	TRANSISTOR NPN BFT25A	1
SM207178541	IC BUFFER/LINE DR HCT541	5
SM207360125	IC TRANSLATO MC10125	11
SM207460116	IC LINE RECEIVER 10H116	6
SM207480823	IC 9-BIT BUS INT FF 74BCT29823	2
SM207770201	IC ANALOG SWITCH DG201	7
SM207770403	IC ANALOG SWITCH DG403	4
SM207770442	IC ANALOG SWITCH DG442	3
SM207878245	IC BUS TRANSCVR HCT 245	6
SM207978153	IC 4-INPUT MUX HCT153	1
SM207978251	IC 8-IN MUX 3-ST 74HCT251	1
SM208030245	IC TRANS ARRAY NPNX6 SL3245	1
SM208470324	IC OP AMP LM324M	4
SM208470347	IC J-FET OP AMP 347	7
SM208470353	IC DUAL OP AMP 353	2
SM208470358	IC DUAL OP AMP 358D	1
SM208470705	IC OP AMP PICOAMP INPUT AD705	6
SM208580336	IC REF DIODE LM336-2.5V	1
SM208765041	IC 8-BIT AD SERIAL MC145041	1
SM208870339	IC VOLT COMPARATOR 339	4
SM208971881	IC VIDEO SYNC SEPARATOR LM1881	1
SM232022822	DIODE ARRAY SCHTTKY 2822	1
SM232120070	DIODE ARRAY BAV70	2
SM234101385	DIODE VOLT REG 385-1.2	1
SM236030099	DIODE SO-PKG BAV99	13
SM236654004	DIODE RECTIFIER 4004	1
SM240050033	DIODE ZENER TZM-C-3V3	3
SM240050051	DIODE ZENER TZM-C-5V1	4
SM252023018	DIODE PIN BAT 18	5
SM252080682	DIODE PIN BA682	5
SM253032821	DIODE SCHOTTKY 2821	1
SM270030020	TRANSISTOR NPN BFS20	1
SM270130092	TRANSISTOR NPN BFR92A	24
SM270130093	TRANSISTOR NPN BFR93A	1

PART: S9314A-3 DESC: MAIN CARD (FRONT END, ADC, TDC) FOR 9314A/M/L

COMPONENT	PART DESCRIPTION	QTY PER ASSEMBLY
-----	-----	-----
SM270140092	TRANSISTOR NPN BFR92AR	1
SM270330848	TRANSISTOR NPN BC848C	5
SM275030092	TRANSISTOR PNP BFT92	15
SM275030093	TRANSISTOR PNP BFT93	4
SM275030550	TRANSISTOR PNP BF550	1
SM275040093	TRANSISTOR PNP BFT93R	6
SM275040550	TRANSISTOR PNP BF550R	1
SM275330858	TRANSISTOR PNP BC858C	11
SM280124416	TRANSISTOR JFET N-CH SST4416	5
SM289240062	TRANSISTOR ARRAY BCV62	5
SM289772003	TRANSISTOR ARRAY 2003	4
SM300446150	INDUCTOR .015UH	1
SM300486104	INDUCTOR WOUND 100uH	4
SM300546151	INDUCTOR .15 UH	1
SM301502001	BEAD (FERRITE CHIP)	40
SM651104151	RES CHIP 1% 25PPM 150 OHMS	1
SM651104182	RES CHIP 1% 25PPM 1.8K	1
SM651104183	RES CHIP 1% 25PPM 18 K	1
SM651104204	RES CHIP 1% 25PPM 200 K	1
SM651104391	RES CHIP 1% 25PPM 390 OHMS	1
SM651104392	RES CHIP 1% 25PPM 3.9K	1
SM652101100	RES CHIP (E24) 1% 10 OHMS	25
SM652101101	RES CHIP (E24) 1% 100 OHM	42
SM652101102	RES CHIP (E24) 1% 1 K	4
SM652101103	RES CHIP (E24) 1% 10 K	81
SM652101104	RES CHIP (E24) 1% 100 K	2
SM652101105	RES CHIP (E24) 1% 1 M	16
SM652101106	RES CHIP (E24) 1% 10 MEG	1
SM652101111	RES CHIP (E24) 1% 110 OHM	1
SM652101114	RES CHIP (E24) 1% 110 K	4
SM652101120	RES CHIP (E24) 1% 12 OHMS	4
SM652101121	RES CHIP (E24) 1% 120 OHM	1
SM652101122	RES CHIP (E24) 1% 1.2 K	15
SM652101131	RES CHIP (E24) 1% 130 OHM	3
SM652101151	RES CHIP (E24) 1% 150 OHM	17
SM652101152	RES CHIP (E24) 1% 1.5 K	18
SM652101153	RES CHIP (E24) 1% 15 K	2
SM652101163	RES CHIP (E24) 1% 16 K	4
SM652101180	RES CHIP (E24) 1% 18 OHMS	1
SM652101181	RES CHIP (E24) 1% 180 OHM	7
SM652101182	RES CHIP (E24) 1% 1.8 K	8
SM652101185	RES CHIP (E24) 1% 1.8 M	4
SM652101200	RES CHIP (E24) 1% 20 OHMS	8
SM652101201	RES CHIP (E24) 1% 200 OHM	6
SM652101202	RES CHIP (E24) 1% 2 K	9

PART: S9314A-3 DESC: MAIN CARD (FRONT END, ADC, TDC) FOR 9314A/M/L

COMPONENT	PART DESCRIPTION	QTY PER ASSEMBLY
-----	-----	-----
SM652101220	RES CHIP (E24) 1% 22 OHMS	3
SM652101221	RES CHIP (E24) 1% 220 OHM	10
SM652101222	RES CHIP (E24) 1% 2.2 K	7
SM652101223	RES CHIP (E24) 1% 22 K	5
SM652101240	RES CHIP (E24) 1% 24 OHMS	20
SM652101241	RES CHIP (E24) 1% 240 OHM	4
SM652101242	RES CHIP (E24) 1% 2.4 K	1
SM652101243	RES CHIP (E24) 1% 24 K	4
SM652101271	RES CHIP (E24) 1% 270 OHM	6
SM652101272	RES CHIP (E24) 1% 2.7 K	9
SM652101273	RES CHIP (E24) 1% 27 K	8
SM652101300	RES CHIP (E24) 1% 30 OHMS	2
SM652101301	RES CHIP (E24) 1% 300 OHM	8
SM652101302	RES CHIP (E24) 1% 3 K	5
SM652101330	RES CHIP (E24) 1% 33 OHMS	5
SM652101331	RES CHIP (E24) 1% 330 OHM	15
SM652101332	RES CHIP (E24) 1% 3.3 K	18
SM652101333	RES CHIP (E24) 1% 33 K	4
SM652101334	RES CHIP (E24) 1% 330 K	5
SM652101360	RES CHIP (E24) 1 % 36 OHM	4
SM652101361	RES CHIP (E24) 1% 360 OHM	2
SM652101390	RES CHIP (E24) 1% 39 OHMS	13
SM652101391	RES CHIP (E24) 1% 390 OHM	14
SM652101392	RES CHIP (E24) 1% 3.9 K	8
SM652101431	RES CHIP (E24) 1% 430 OHM	2
SM652101470	RES CHIP (E24) 47 OHMS	7
SM652101471	RES CHIP (E24) 1% 470 OHM	52
SM652101472	RES CHIP (E24) 1% 4.7 K	1
SM652101474	RES CHIP (E24) 1% 470 K	1
SM652101475	RES CHIP (E24) 1% 4.7 M	6
SM652101510	RES CHIP (E24) 1% 51 OHMS	27
SM652101511	RES CHIP (E24) 1% 510 OHM	8
SM652101512	RES CHIP (E24) 1% 5.1 K	29
SM652101513	RES CHIP (E24) 1% 51 K	1
SM652101560	RES CHIP (E24) 1% 56 OHM	16
SM652101561	RES CHIP (E24) 1% 560 OHM	5
SM652101562	RES CHIP (E24) 1% 5.6 K	7
SM652101621	RES CHIP (E24) 1% 620 OHM	5
SM652101622	RES CHIP (E24) 1% 6.2 K	3
SM652101623	RES CHIP (E24) 1% 62 K	2
SM652101680	RES CHIP (E24) 1% 68 OHMS	38
SM652101681	RES CHIP (E24) 1% 680 OHM	2
SM652101683	RES CHIP (E24) 1% 68 K	4
SM652101684	RES CHIP (E24) 1% 680 K	1
SM652101750	RES CHIP (E24) 1% 75 OHMS	10

PART: S9314A-3 DESC: MAIN CARD (FRONT END, ADC, TDC) FOR 9314A/M/L

COMPONENT	PART DESCRIPTION	QTY PER ASSEMBLY
-----	-----	-----
SM652101751	RES CHIP (E24) 1% 750 OHM	8
SM652101820	RES CHIP (E24) 1% 82 OHMS	5
SM652101821	RES CHIP (E24) 1% 820 OHM	5
SM652101822	RES CHIP (E24) 1% 8.2 K	4
SM652101824	RES CHIP (E24) 1% 820 K	1
SM652101910	RES CHIP (E24) 1% 91 OHMS	1
SM652101912	RES CHIP (E24) 1% 9.1 K	1
SM652101913	RES CHIP (E24) 1% 91 K	4
SM652110904	RES CHIP 900K 0.5%	7
SM652113523	RES CHIP (24) 0.3% 52.63 K	4
SM652113954	RES CHIP (E24) 0.3% 950 K	4
SM653185100	RES THICK FILM 10 OHMS	4
SM653185560	RES THICK FILM 56 OHMS	1
SM654101000	CHIP JUMPER ZERO OHMS	5
SM661127104	CAP CERA CHIP 20% .1 UF	20
SM661205822	CAP CERA CHIP 8200PF	2
SM661207103	CAP CERA CHIP 20% .01UF (0805)	392
SM661207223	CAP CERA CHIP 20% .022 UF	4
SM661250047	CAP CERA CHIP 4.7 PF	1
SM661250082	CAP CERA CHIP .1% 8.2 PF	1
SM661255012	CAP CERA CHIP 5% 1.2 PF	1
SM661255027	CAP CERA CHIP 2.7 PF	5
SM661255033	CAP CERA CHIP 3.3 PF	1
SM661255056	CAP CERA CHIP 5.6 PF	8
SM661255068	CAP CERA CHIP 6.8 PF	2
SM661255100	CAP CERA CHIP 10PF	5
SM661255101	CAP CERA CHIP 5% 100 PF	6
SM661255181	CAP CERA CHIP 5% 180 PF	4
SM661255220	CAP CERA CHIP 5% 22 PF	4
SM661255270	CAP CERA CHIP 27PF	7
SM661255331	CAP CERA CHIP 5% 330 PF	1
SM661255470	CAP CERA CHIP 47PF	1
SM661255560	CAP CERA CHIP 56PF	2
SM661255820	CAP CERA CHIP 5% 82 PF	4
SM661255821	CAP CERA CHIP 5% 820 PF	1
SM661256120	CAP CERA CHIP 10% 12 PF	1
SM661446474	CAP CERA CHIP 10% .47 UF	1
SM661495561	CAP CERA CHIP 5% 560 PF	5
SM661726103	CAP CERA CHIP 10% .01UF (2220)	12
SM666237476	CAP MOLD TANT CHIP 47 UF	9
SM666247106	CAP MOLD TANT CHIP 10 UF	10
SM666317475	CAP MOLD TANT CHIP 4.7 UF	1
SM666327225	CAP MOLD TANT CHIP 2.2 UF	29
SM666377226	CAP MOLD TANT CHIP 22 UF	2
SM666427105	CAP MOLD TANT CHIP 1 UF	2

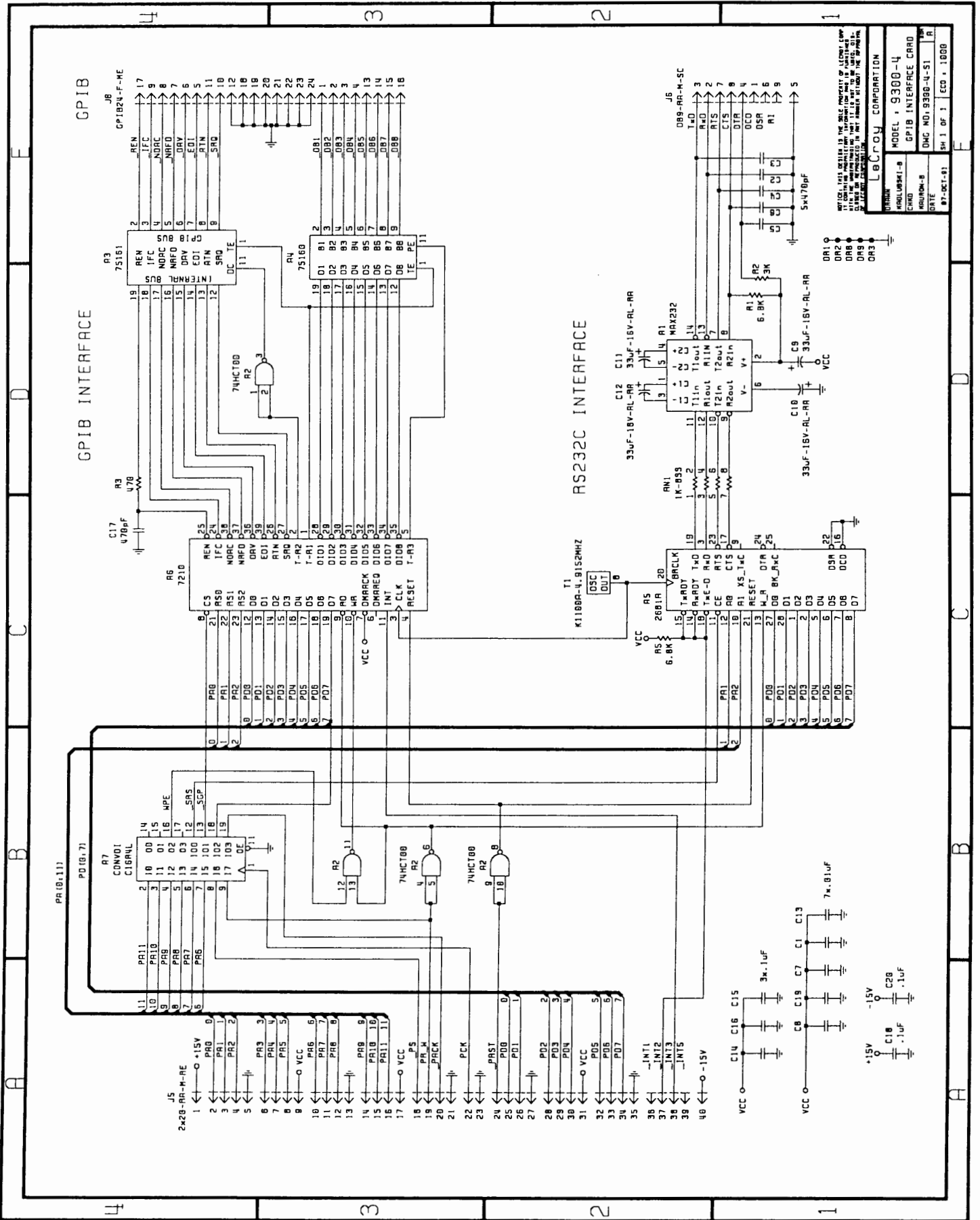

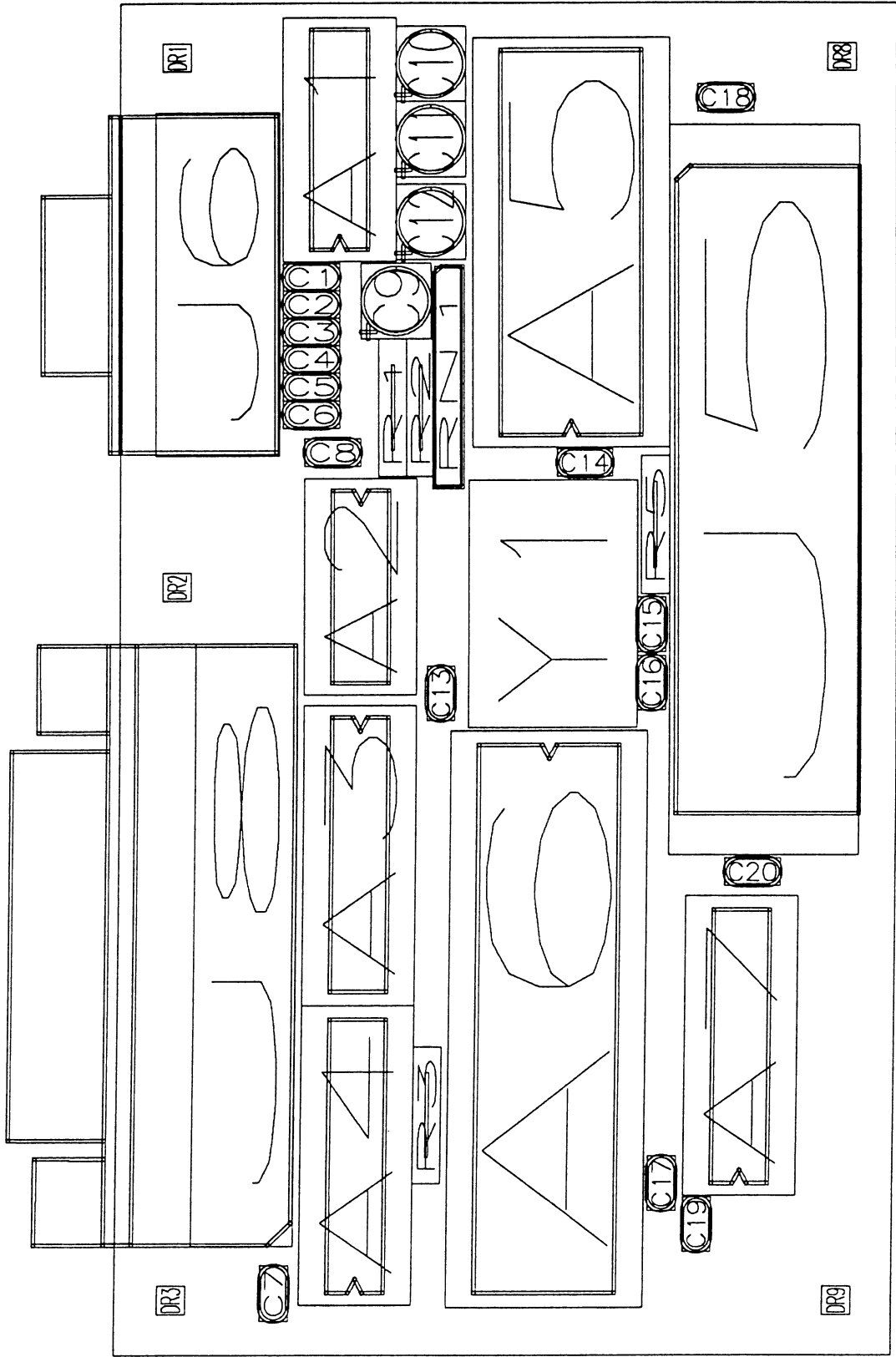

9300-4 REV : D

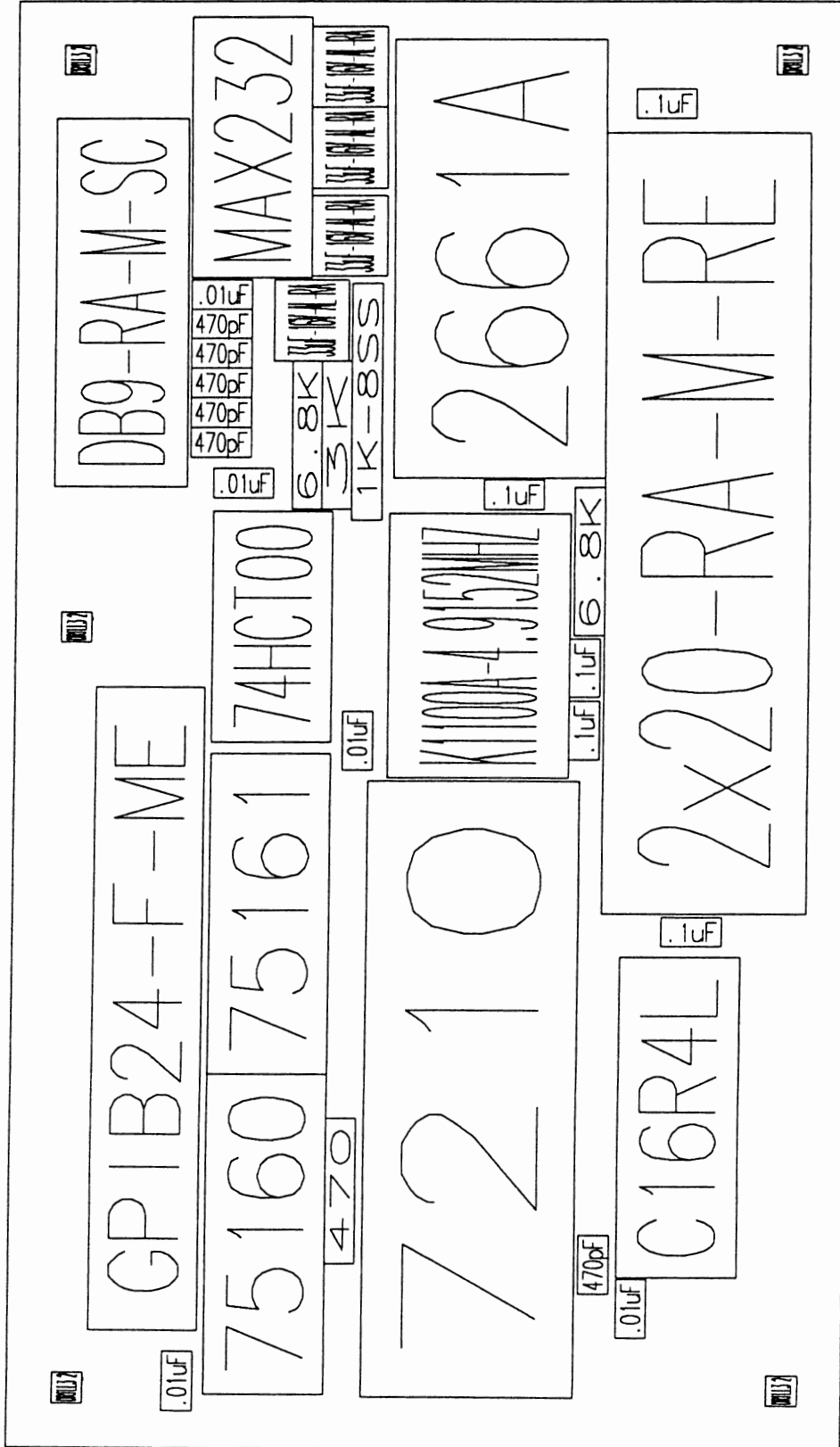

9300-4 REV:D

SECTION 9 MECHANICAL PARTS

9314A, 9314AM, 9314AL Digital Oscilloscope

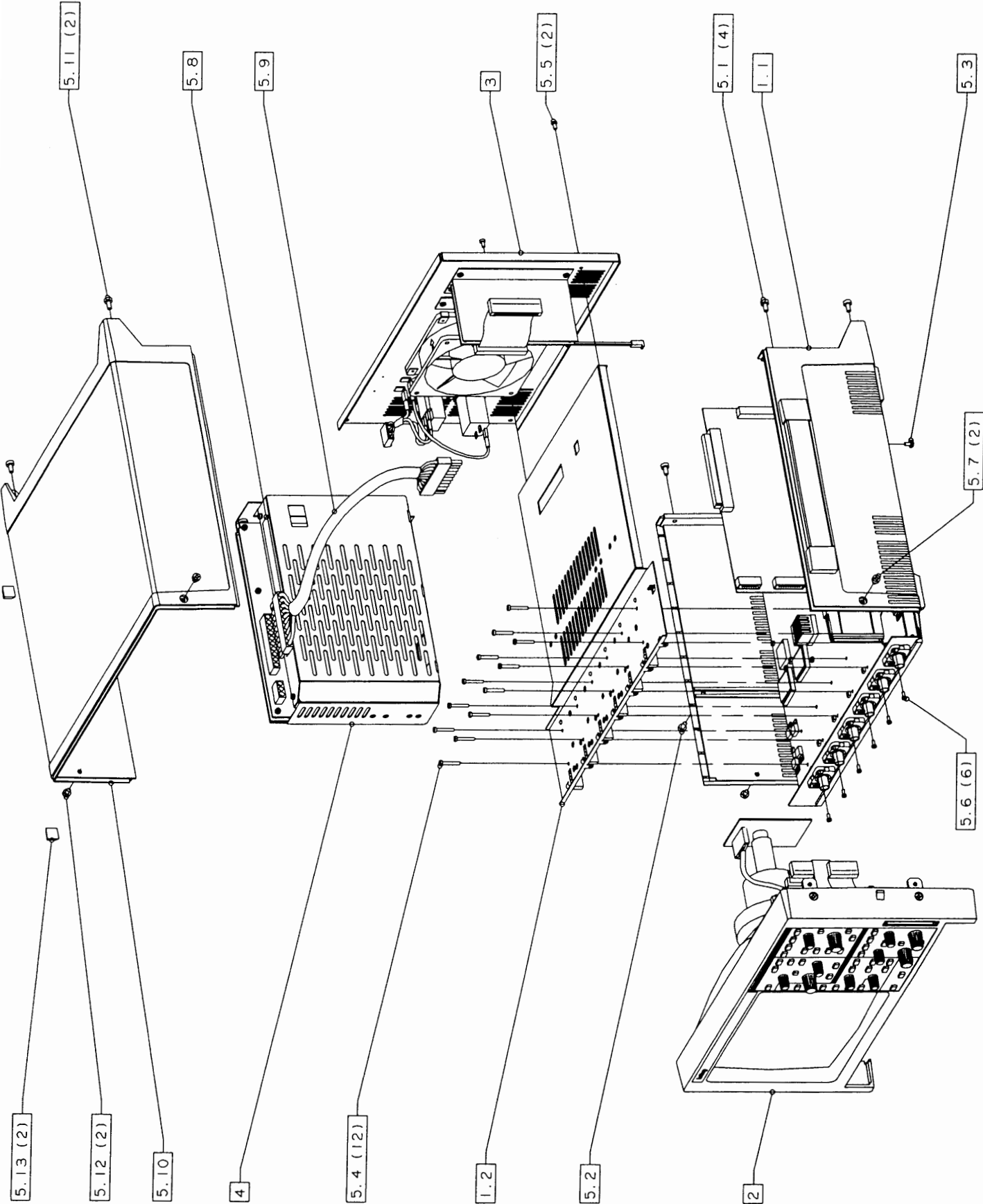

Figure 9.1 : 9314A/M/L DSO Exploded View

	9314A/M/L Assembly	Part Description	Quantity per Assembly
	-----	-----	-----
1.1	9314A lower cover assembly	LC93X1	1
1.2	9314A upper shield assembly	US9314A-3	1
2.	9314A front frame assembly		1
3.	Rear panel assembly		1
4.	Power supply	93XX-PS1715	1
5.1	Screw oval head M4x8	550 440 608	4
5.2	Screw oval head M4x8	550 440 608	1
5.3	Screw eco fix M3x6	550 430 706	1
5.4	Screw cyl head M3x20	550 430 120	12
5.5	Screw eco fix M3x6	550 430 706	2
5.6	Self tapping screw M2.5x6	554 425 003	6
5.7	Screw oval head M4x8	550 440 608	2
5.8	Label " Danger "	377 051 005	1
5.9	Power Cable	780 220 033	1
5.10	9314A Upper cover	UC 93X1	1
5.11	Screw oval head M4x8	550 440 608	2
5.12	Screw M4x5	550 440 605	2
5.13	Foot bumpon grey 6 mm	485 023 462	2

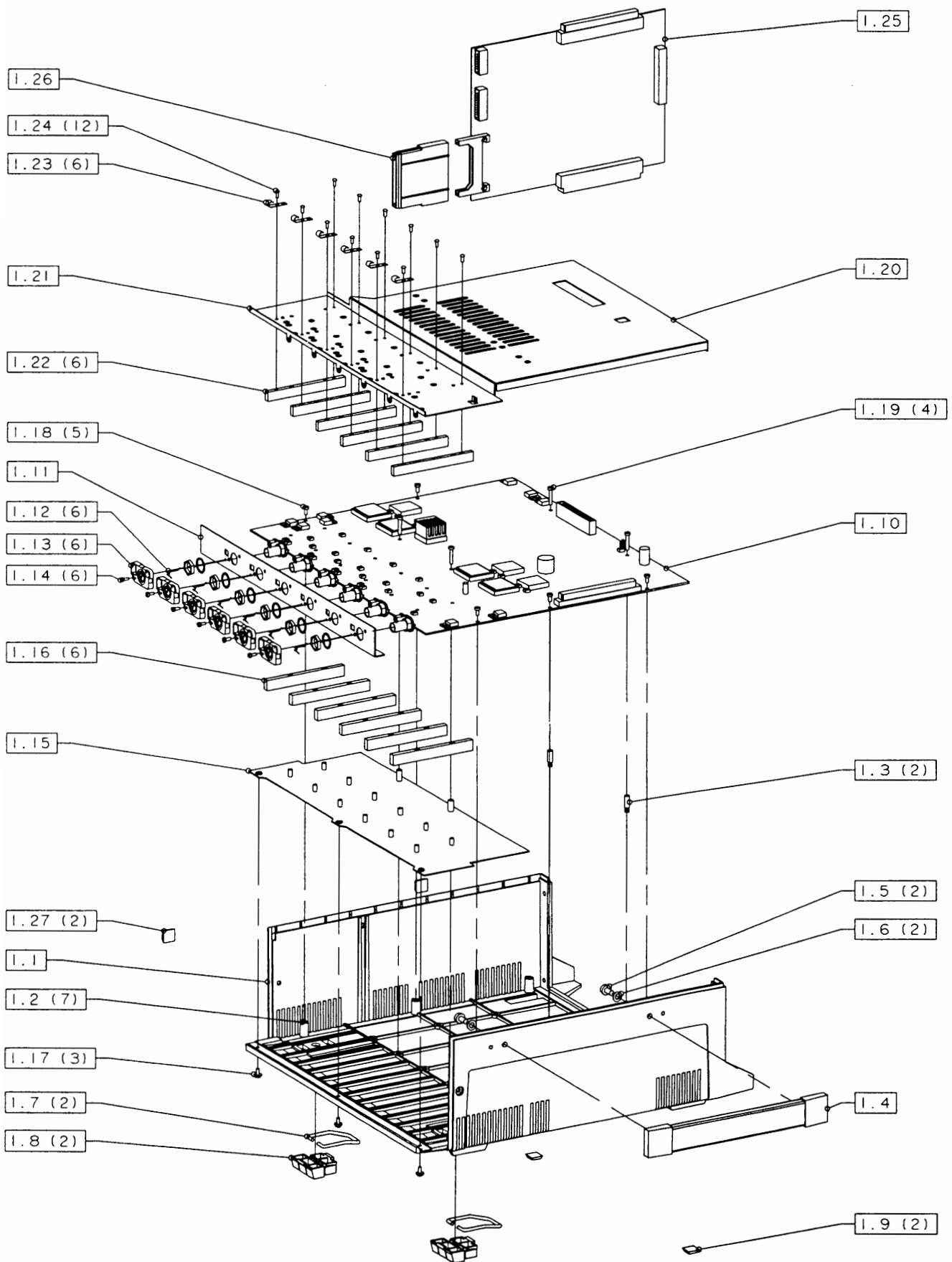

Figure 9.2 : 9314A/M/L Lower Cover Exploded View

1.	9314A/M/L Lower Cover Assembly Part Description		Quantity per Assembly
1.1	Lower cover	LC 93X1	1
1.2	Nut Banc-Lock M3	554 030 101	7
1.3	Main card standoff 12 mm M3	709 3xx 321	2
1.4	Handle with caps	530 301 009	1
1.5	Screw cyl head 10-32 x 1/2	560 032 008	2
1.6	Lockwasher M5	551 450 400	2
1.7	Foot	709 3xx 051	2
1.8	Foot support	709 3xx 041	2
1.9	Foot bumpon grey 3 mm	485 123 001	2
1.10	Main board 9314A	F9314A-3	1
	Main board 9314AM	F9314AM-3	1
	Main board 9314AL	F9314AL-3	1
1.11	Main board panel 9314A	FP9314A-3	1
1.12	Probe ring contact	709 3xx P91	6
1.13	Probe holder	709 3xx P41	6
1.14	Self tapping screw M2,5x6	554 425 003	6
1.15	9314A base shield	709 314A 331	1
1.16	Lower partition	709 3XX 361	6
1.17	Screw eco-fix M3x6	550 430 706	3
1.18	Screw cyl head M3x6	550 430 106	5
1.19	Screw cyl head M3x16	550 430 116	4
1.20	Upper shield assembly	US9314A-3	1
1.21	Upper shield	709 314A 321	1
1.22	Upper partition shield	709 3XX 351	6
1.23	Shield contact	709 3XX 371	6
1.24	Nail rivet M2,5x6	554 425 004	12
1.25	9314A/M/L Processor card	F9300-1-2 or F9314M-1	1
1.26	Memory card insertion guide	709 424 096	1
1.27	Self adhesive foot	485 023 462	2

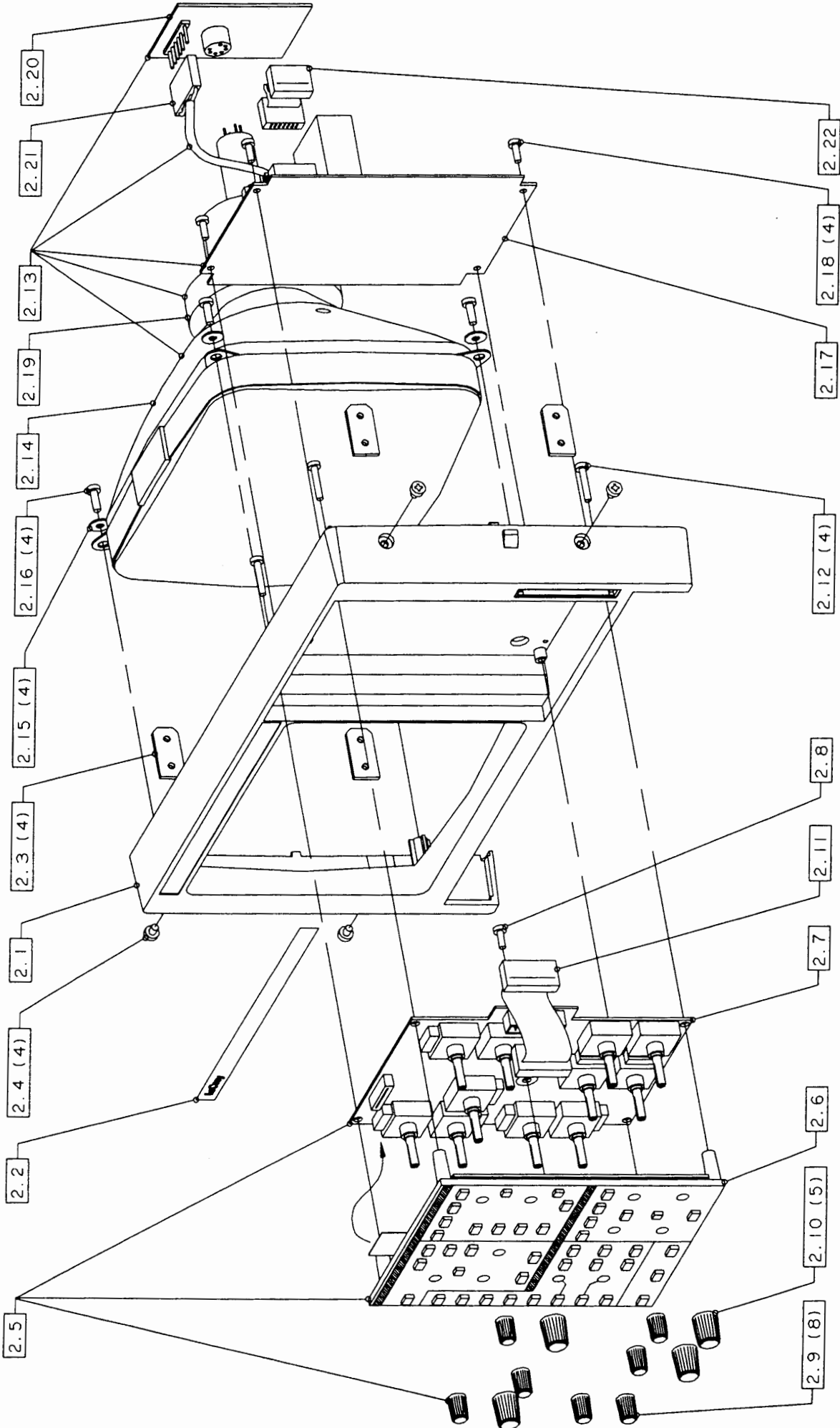

Figure 9.3 : 9314A/M/L Front Frame Exploded View

2.	9314A/M/L Front Panel Assembly	Part Description	Quantity per Assembly
2.1	Front frame	FF 93X1	1
2.2	Front label 9314A	709 314A26	1
	Front label 9314AM	709 314AM26	1
	Front label 9314AL	709 314AL26	1
2.3	Front frame bracket	709 3XX 091	4
2.4	Screw oval head M4x5	550 440 605	4
2.5	Front panel assembly	F9354-5	1
2.6	Front panel keyboard ass'y	729 354 513	1
2.7	Front panel pcb ass'y	9354-5	1
2.8	Screw PT KA 35x10	554 435 004	1
2.9	Knob diameter 10mm	709 3XX 511	8
2.10	Knob diameter 14mm	709 3XX 521	5
2.11	20 lines flat cable	780 721 105	1
2.12	Screw PT KA 35x20	554 435 003	4
2.13	Raster monitor kit	93XX-Display	1
2.14	9 inch CRT	93XX-CRT	1
2.15	Flat washer M4	554 440 202	4
2.16	Screw PT KA 40x12	554 440 001	4
2.17	Deflection board	93XX-Deflection	1
2.18	Screw PT KA 35x10	554 435 004	4
2.19	Deflection yoke	93XX-Yoke	1
2.20	Video board	93XX-Video	1
2.21	Monitor cable		1
2.22	14 lines flat cable	780 661 104	1

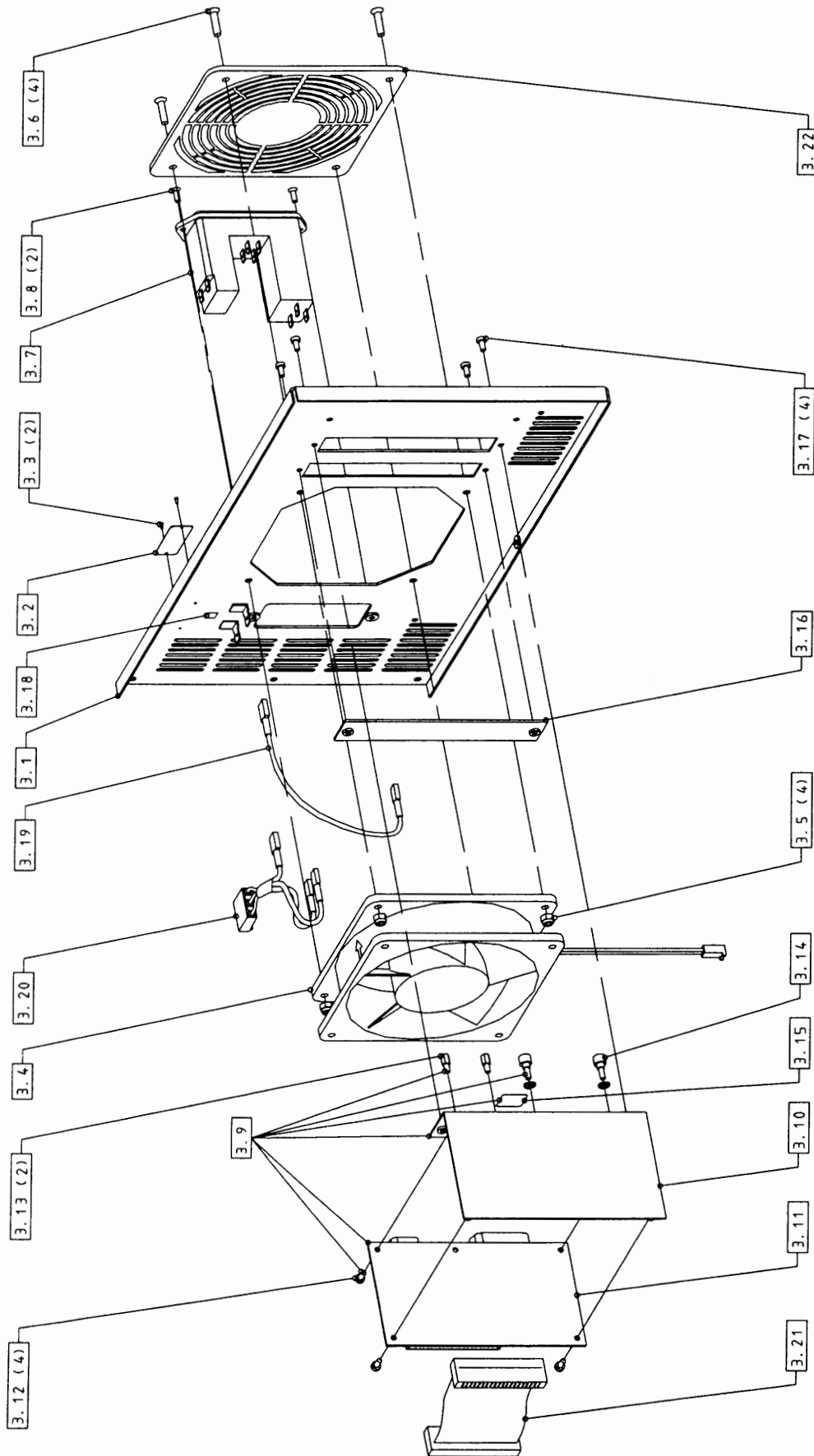

Figure 9.4 : 9314A/M/L Rear Panel Exploded View (ECO 1000)

3	9314A/M/L Rear Panel Assembly	Part Description	Quantity per Assembly

ECO 1000			
3.1	Rear panel	RP 93XX-9	1
3.2	Serial number plate	709 314 913	1
3.3	Taping screw	554 500 001	2
3.4	Fan assembly	709 3XX 901	1
3.5	Nut open end acorn M4	552 440 300	4
3.6	Screw flat head M4x16	550 440 516	4
3.7	Line input module	434 690 002	1
	Fuse holder	407 036 002	1
	Fuse 5A / 250 V	433 162 500	2
3.8	Screw flat head M3x8	550 430 508	2
3.9	RS232/GPIB interface assembly	F9300-4	1
3.10	Interface card bracket	709 300 411	1
3.11	Interface card	9300-4	1
3.12	Screw cyl head M3x6	550 430 106	4
	Washer Shakeproof M3	551 430 400	4
3.13	Mounting hardware	455 980 002	2
3.14	Connector kit	435 521 024	2
3.15	Label " RS232C "	709 300 421	1
3.16	Interface hole closure	709 3XX 931	1
3.17	Screw cyl head M3x6	550 430 106	4
	Washer shakeproof M3	551 430 400	4
3.18	Ground label	377 131 001	1
3.19	Ground cable	780 754 515	1
3.20	Line input cable	780 681 611	1
3.21	40 lines flat cable	780 671 110	1
3.22	Fan grid	530 904 000	1

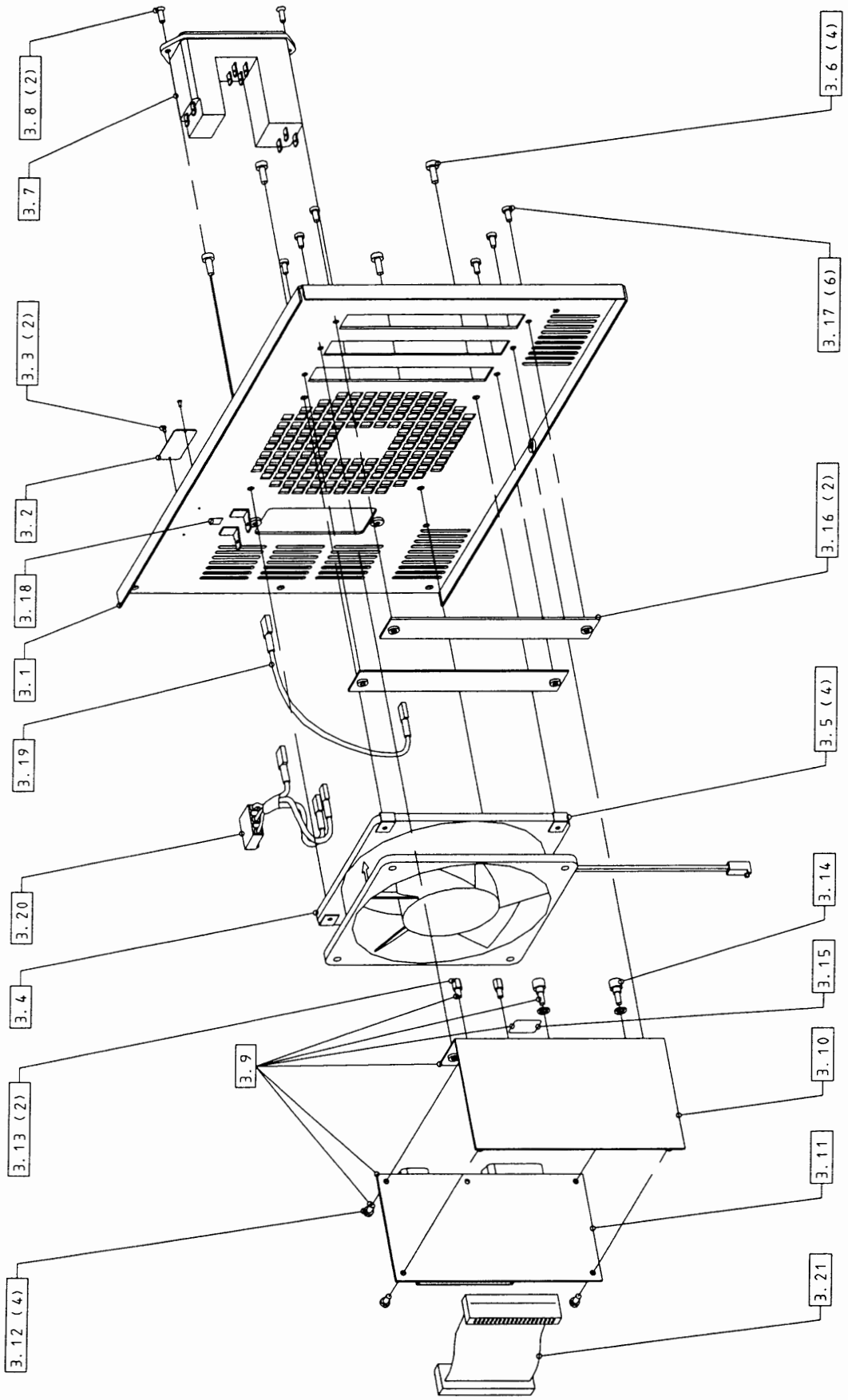

Figure 9.5 : 9314A/M/L Rear Panel Exploded View (ECO 1001)

3	9314A/M/L Rear Panel Assembly	Part Description	Quantity per Assembly
ECO 1001			
3.1	Rear panel	RP 93XX-9	1
3.2	Serial number plate	709 314 913	1
3.3	Taping screw	554 500 001	2
3.4	Fan assembly	709 3XX 901	1
3.5	Clip on nut 3.5	554 035 101	4
3.6	Screw 3.5x9.5	554 435 005	4
3.7	Line input module	434 690 002	1
	Fuse holder	407 036 002	1
	Fuse 5A / 250 V	433 162 500	2
3.8	Screw flat head M3x8	550 430 508	2
3.9	RS232/GPIB interface assembly	F9300-4	1
3.10	Interface card bracket	709 300 411	1
3.11	Interface card	9300-4	1
3.12	Screw cyl head M3x6	550 430 106	4
	Washer Shakeproof M3	551 430 400	4
3.13	Mounting hardware	455 980 002	2
3.14	Connector kit	435 521 024	2
3.15	Label " RS232C "	709 300 421	1
3.16	Interface hole closure	709 3XX 931	2
3.17	Screw cyl head M3x6	550 430 106	6
	Washer shakeproof M3	551 430 400	6
3.18	Ground label	377 131 001	1
3.19	Ground cable	780 754 515	1
3.20	Line input cable	780 681 611	1
3.21	40 lines flat cable	780 671 110	1

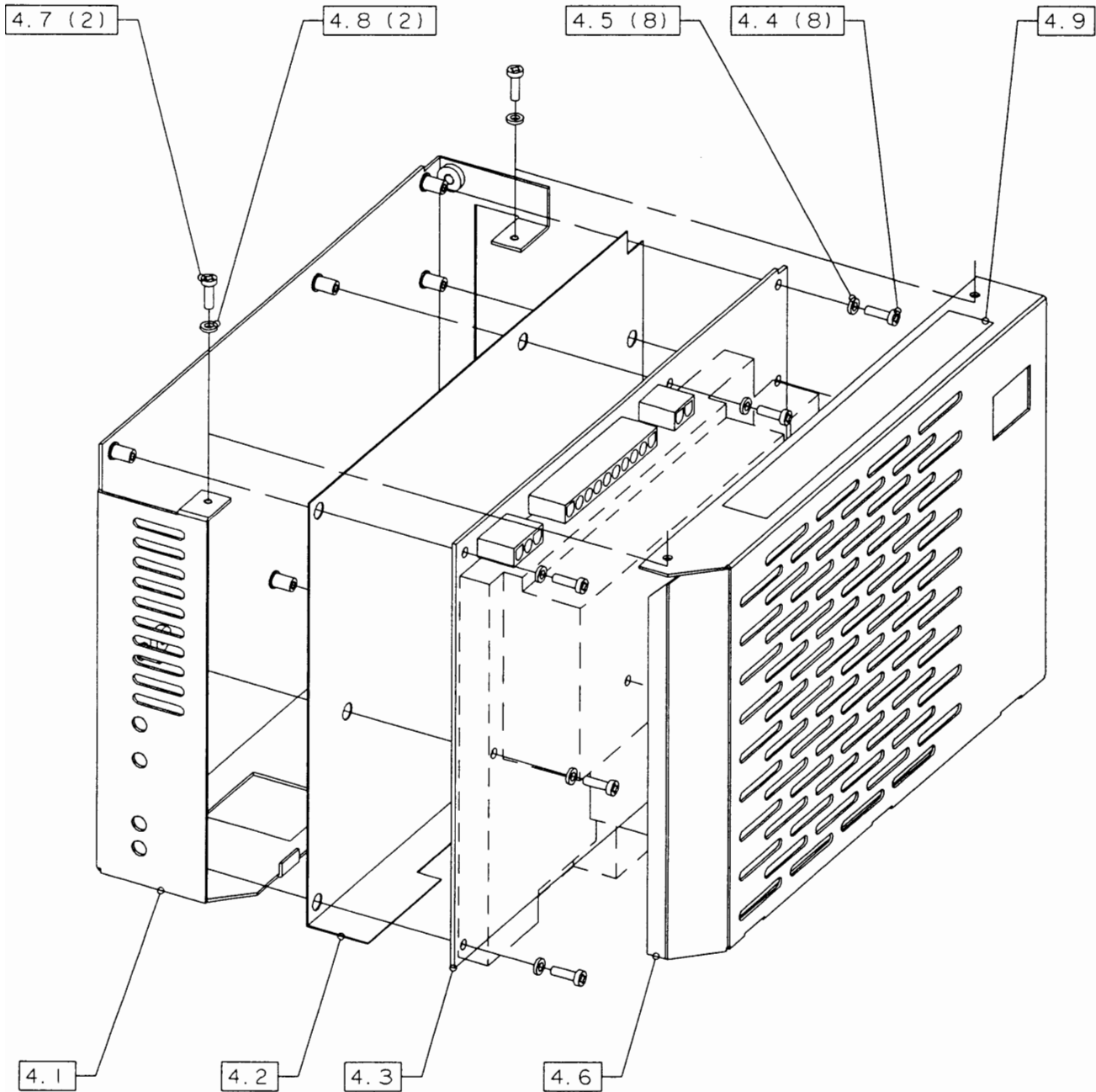

Figure 9.6 : 93XX-PS1715 Power Supply Exploded View

4.	Power supply 93XX-PS1715	Part Description	Quantity per Assembly
4.1	Power supply bracket	709 3XX 071	1
4.2	Power supply insulator	93XX-M11	1
4.3	Power supply board	PS 1715	1
4.4	Screw cyl head M3x6	550 430 106	8
4.5	Lockwasher M3	551 430 400	8
4.6	Power supply cover	709 3XX 081	1
4.7	Screw cyl head M3x6	550 430 106	2
4.8	Lockwasher M3	551 430 400	2
4.9	Label " Danger....only "	377 051 005	1

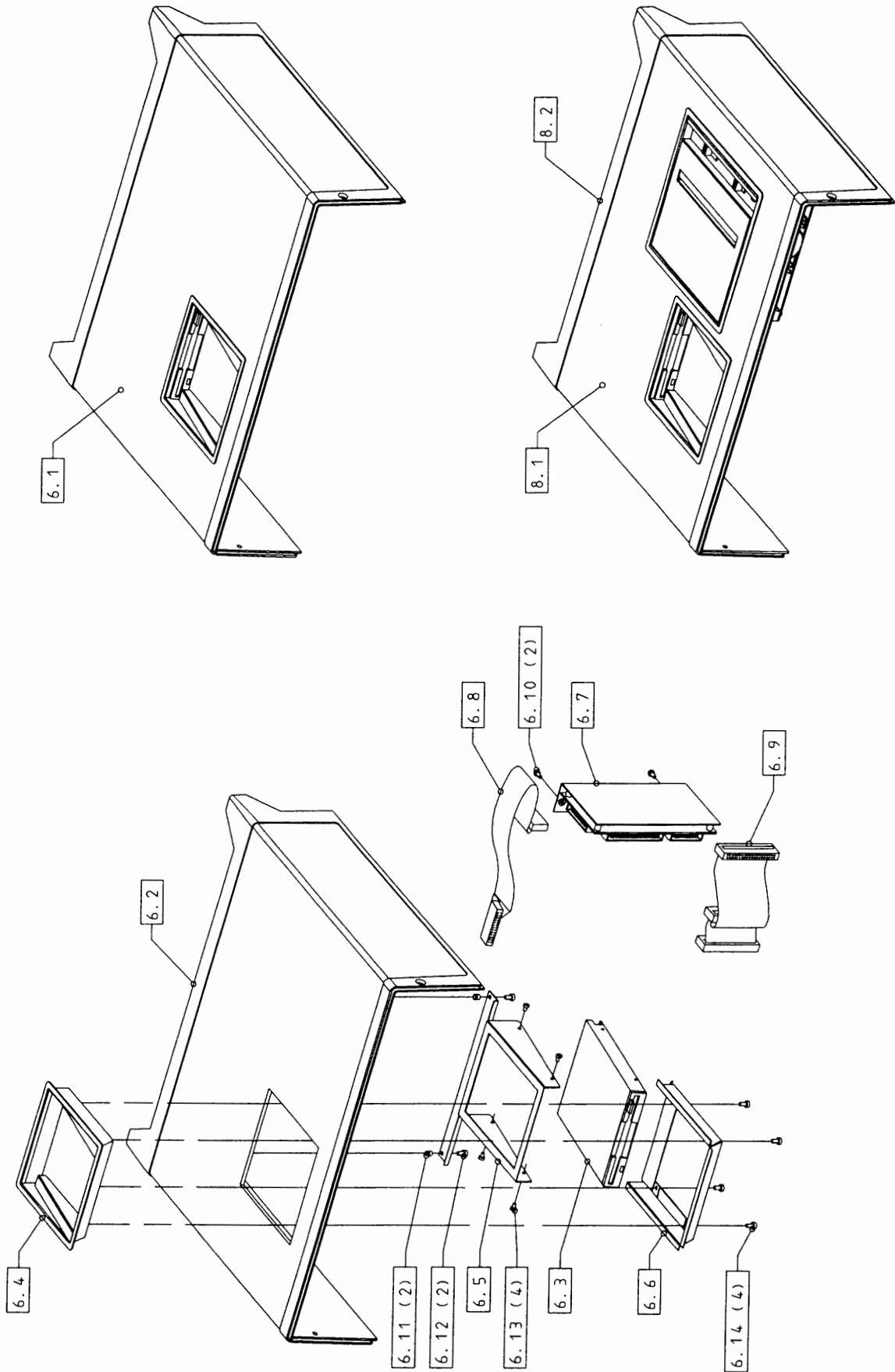

Figure 9.7 : FD01 Floppy Option

6.	FD01 Floppy Option	Part Description	Quantity per Assembly
	-----	-----	-----
6.1	Floppy drive option	93XX-FD01	1
6.2	Upper cover	UC93X1-FD01	1
6.3	Floppy drive	335 023 203	1
6.4	Cup	CUP-FD01	1
6.5	Support	70FD01021	1
6.6	Frame	70FD01031	1
6.7	Floppy/Printer/Cent interface	F9300-6	1
6.8	Flat cable 26 P	780 791 630	1
6.9	Flat cable 40 P	780 801 015	1
6.10	Screw M3x6	550 430 106	2
	Washer M3	551 430 400	2
6.11	Nut banc lock M3	554 030 101	2
6.12	Screw M3x6	550 430 106	2
6.13	Screw M2.5x4	550 425 014	4
6.14	Screw self tapping M3x5	554 430 002	4
8.1	Floppy and Printer options	93XX-FDGP	1
8.2	Floppy&Printer Upper cover	UC93X1-FDGP	1

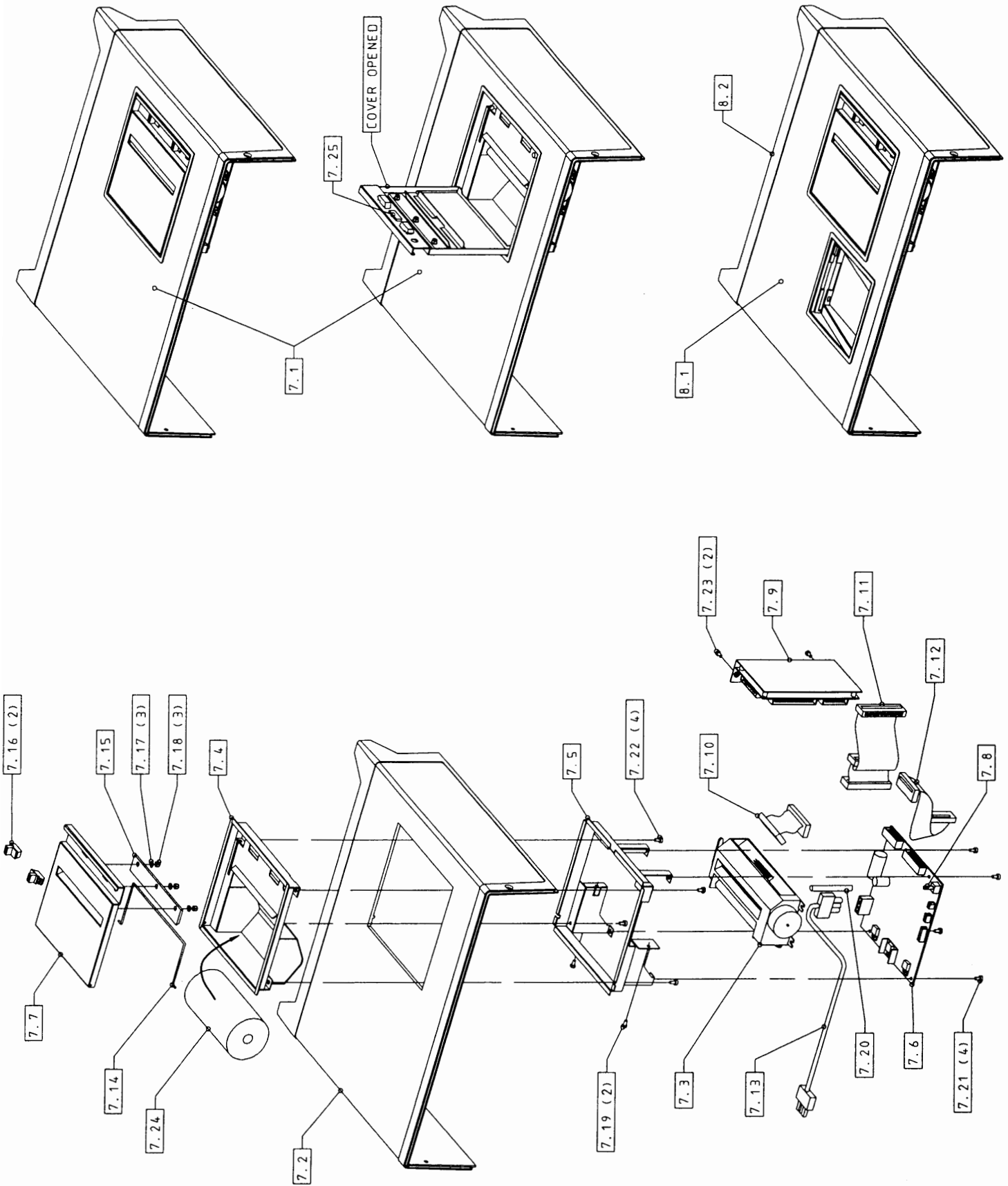

Figure 9.8 : GP01 Printer Option

7.	GP01 Printer Option	Part Description	Quantity per Assembly

7.1	Graphic printer option	93XX-GP01	1
7.2	Upper cover	UC93X1-GP01	1
7.3	Graphic printer	334 000 832	1
7.4	Box	BOX-GP01	1
7.5	Frame	70GP01031	1
7.6	Printer interface card	F9300-7	1
7.7	Cover	COVER-GP01	1
7.8	Switch push button	709 450 523	1
7.9	Floppy/Printer/Cent interface	F9300-6	1
7.10	Flat cable 26 P	780 791 604	1
7.11	Flat cable 40 P	780 801 015	1
7.12	Flat cable 20 P	780 721 022	1
7.13	Power supply cable	780 210 030	1
7.14	Cover Axle	70GP01041	1
7.15	Cutter	70GP01051	1
7.16	Slide latch	530 040 005	2
7.17	Flat washer M3	551 430 100	3
7.18	Nut acorn M3	552 430 300	3
7.19	Screw self tapping M3x5	554 430 002	2
7.20	Push switch extender	70GP01061	1
7.21	Screw M3x6	550 430 106	4
	Washer M3	551 430 400	4
7.22	Screw M3x5	554 430 002	4
7.23	Screw M3x6	550 430 106	2
	Washer M3	551 430 400	2
7.24	Thermal paper roll	344 000 042	1
7.25	Auto adhesive rubber band		1
8.1	Floppy and Printer options	93XX-FDGP	1
8.2	Floppy&Printer Upper cover	UC93X1-FDGP	1

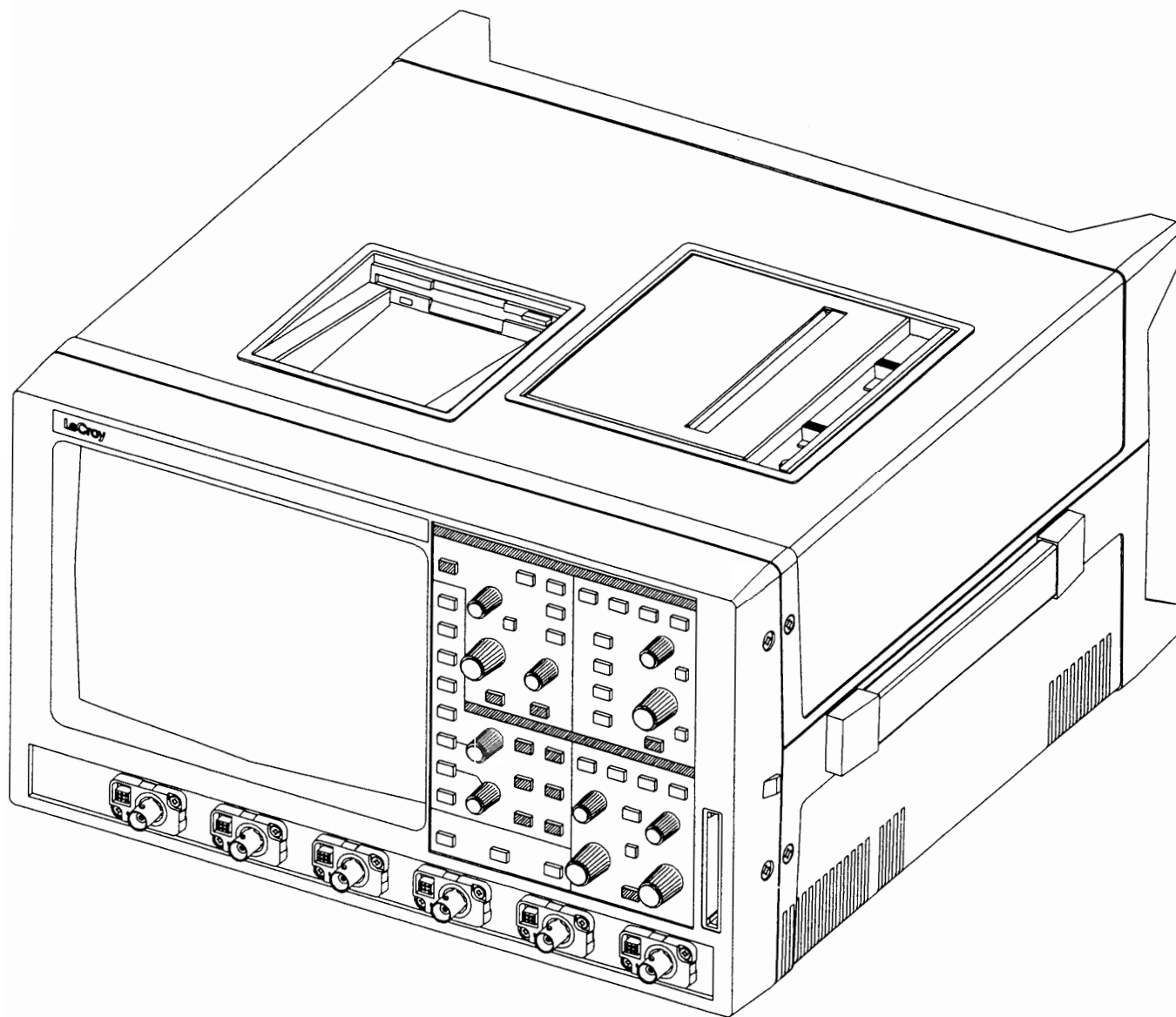

Figure 9.9 : 9314A/M/L DSO Front View

SECTION 10 CONNECTING the 9314A/M/L to a PLOTTER or a PRINTER

10.1 Introduction

LeCroy oscilloscopes are supplied with a list of plotters and printers known to work with them.

This list is not final, so any suggestions are welcome.

HP plotter responses to some RS-232 configuration commands have been evolved. Consequently, the 9314A/M/L generation DSO support HP plotters of two types, 7470A and 7550A. The only difference lies in the RS-232 initialization codes. They may however, despite these changes, work with HPGL compatible plotters from other manufacturers. If the HPGL data is used as input for a CAD or word processing system, it might be necessary to remove the data preceding the in command. Before connecting a plotter to a 9314A/M/L, do not forget to select the appropriate settings in the printer setup menu and the GPIB & RS-232 setup menu.

GPIB & RS232	HARDCOPY
Remote Control from GPIB RS232	output to Card Disk GPIB RS232 Centronics
RS232 Mode 7-bit 8-bit	page feed OFF On
Parity none odd even	protocol HP 7470 HP 7550 TIFF TIFF compr. BMP
Stop bits 1 2	
Baud Rate 300 1200 2400 4800 9600 19200	
GPIB Device Talk Only	

RS-232 connection

The following settings are assumed for the scope.

Baud rate : 9600
 Character : 8 bits
 Parity : none
 Stop bits : 1

Any exceptions will be mentioned.

RS 232 interface

Pin 1 : DCD
 2 : RD
 3 : TD
 4 : DTR
 5 : GND
 6 : DSR
 7 : RTS
 8 : CTS
 9 : RI

A cable with the following pinout can be used in almost every case:

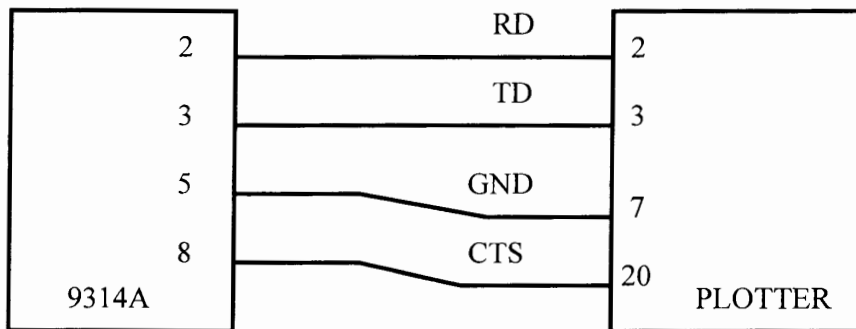

The cable has D25 connector with male pins on the plotter side, and a D9 connector with female pins on the 9314A/M/L oscilloscope side.

GPIB Connection

To have a plot done through GPIB initiated with the front panel screen dump push button, you must set the 9314A/M/L in talk only mode by selecting remote control from RS-232, and the plotter in listen only mode.

If a computer controls the GPIB Bus, both the scope and the plotter must be set in addressed mode (remote control from GPIB).

Remark: the listen only mode does not work on some old HP plotters such as HP7585B or HP7475. The plotter must be set to listener before being able to receive any commands, which is a violation of the GPIB standard.

10.2 Plotters

10.2.1 HP 7470A Plotter

Switch settings:

- RS-232 Connection:

S1 and S2 : 0 0

Y/D : D

A4/US : User selectable

B4 to B1 : 1 0 1 0

- GPIB listen only:

A4/US : User selectable

16 to 1 : 1 1 1 1 1

- GPIB Addressed:

A4/US : User selectable

16 to 1 : 0 0 1 1 1

10.2.2 HP 7550A Plotter

Responses to some ESC characters commands are not the same in this plotter as in older HP models like the 7470A. In fact, ESC sequences of commands which give excellent results in the 7470A can prevent any handshake in RS-232. Problems of this kind have been reported in the case of ESC.R and ESC.@ commands. When combined with ESC.I and ESC.N, ESC.@ breaks up all handshakes.

RS-232 configuration:

- Enter into display 5 (HP-IB MONITOR...).
- Select STANDARD OF STANDARD/ENHANCED.
- Enter into SERIAL sub-menu (display 6)
- For DATA_FLOW, select REMOTE. Either STANDALONE or EAVESDROP may be chosen.
- Enter into display 7 (DUPLEX, PARITY, BAUD).
- Select FULL duplex.
- Configuration PARITY and BAUD rate to the same values as on the DSO.

A standard cable may be used.

Do not start a plot while a sheet of paper is being loaded!

GPIB configuration:

If the scope is in TALK ONLY, the plotter must be in LISTEN ONLY. Selection will be done at display 5.

Note : Its seems that the plotter must be powered off, then on again, to take any configuration change into account.

10.2.3 Hitachi 672 Graph Plotter (or NSA 672)

As this plotter is compatible with the 7470A, select this mode on the plotter menu page.
Switch settings

- RS-232 Connection:

Sw. A, 1 and 2 : 1 1 (ISO A3) or (ISO A4).
Sw. A, 3 to 8 : 1 0 1 1 0 1
Sw. B : 1 1 1 1

Note : When switches are set to ISO A4, the pen must be manually repositioned at the top of the page (or plotter reset by powering it off and on) before loading a new sheet of paper.

10.3 Printers

Interfacing is possible through RS-232, GPIB directly, and in option through Centronics. The parallel interface F9300-6 (Centronics) is an option, see section 4.5.

10.3.1 Centronics Printers

Most printers use a Centronics parallel connection which makes direct connection possible if the 9314A/M/L is equipped with the optional Centronics interface F9300-6 board. If the printer has a Centronics connector then it's a parallel printer, and the F9300-6 board is required or a serial to parallel converter.

If a serial to parallel converter is used, in the printer setup menu select device type Epson, and remote control from RS-232.

RS-232 Remote control port settings:

Baud rate : 9600 or 19200
Characters length (bits) : 8
Parity : none
Number of stop bits : 1

The following printers and printer switch positions have been tested via serial to parallel adapter.

	Switch 1	Switch 2
1. Epson LQ-1000	1, 2, 3, 4 : ON	2, 6, 7 : ON
2. Diconix 150P	1: ON	2, 6, 7 : ON
3. HP-ThinkJet 2225C	2, 4, 5 : ON	
4. HP-DeskJet 550 C	all down	6 up for 19200 bauds

Note: all Epson and Epson Compatible printers are likely to work if the switches are set properly, (Some experimentation may be required).

Some available serial to parallel converters need power through the RS-232 lines. Do not use them, as we do not guarantee that the serial port is able to furnish enough power.

10.3.2 RS-232 Printers

10.3.2.1 Epson FX80

It is possible to use the standard RS-232 cable. Such a printer has the optional RS-232 interface " #8143 " installed. The configuration that follows is valid for the default scope setting. The standard cable is usable.

In the particular case of an FX850:

- the main switches SW1 SW2 remain at the factory configuration

SW1	:	1	2	3	4	5	6	7	8
		OFF	OFF	ON	OFF	OFF	ON	ON	ON

SW2	:	1	2	3	4
		ON	OFF	OFF	OFF

- the 8143 switches are set to:

1	2	3	4	5	6	7	8
ON	OFF	OFF	OFF	n/a	OFF	OFF	ON

- the 8143 jumpers remain at the factory settings:

J1	J2	J3	J4	J5	JC	JNOR	JRVE	JF	JX
OFF	OFF	OFF	OFF	ON	OFF	ON	OFF	ON	OFF

Note: Epson printers only support XON/XOFF support handshake if they have a print buffer. Such printer are : FX, FX+, JX-80, LQ-800/1000, EX-800 and LQ-25000. Otherwise, use DTR/RTS handshake.

10.3.2.2 Citizen 120D

To use this printer with the default RS-232 setting and default printer setting of the 9314A/M/L, select the following switch configuration:

DIP switch bank 1 : all OFF except 3 and 8, DIP switch bank 2 : all OFF.

10.3.2.3 HP LaserJet

Make sure that page feed is ON in the plotter menu to use the LaserJet. It is advisable to start out in single density with a size of A5. Then, depending upon the internal buffer size on the LaserJet, the image size and/or density can be increased. At one point, the internal buffer size of the DSO is also reached. The image is simply truncated, indicating that either density or size have to be reduced.

10.3.2.4 HP QuietJet

10.3.2.5 HP ThinkJet

To use printer with the default RS-232 setting and with the default cable select the following switch configuration:

- mode switch:

1 2 3 4	5 6 7 8
0 0 0 0 : 11" page length	0 0 0 0
1 : 12" page length	

- RS-232 switch:

1	2 3	4 5
1	0 0	0 0
(use DTR handshake)	(8bits, parity none)	(9600 bauds)

Note : it may be possible that old ThinkJet recognize only the Epson protocol. If it is the case use the Epson.

10.3.2.6 HP DeskJet 550C

The standard cable is usable. The printer has been tested at 19200 bauds with the following configuration :

Switch 1 or Bank A : all down

Switch 2 or Bank B : 6 up for 19200 bauds, all the other down

10.3.2.7 Brother Printers

The Brother M-1509 and M-1709 have been tested with a serial connection. On the oscilloscope select "Epson FX-80 or compatible printer".

The switch settings are identical for both the printers:

- SW1 :	1	2	3	4	5	6	7	8
	ON	ON	ON	OFF	ON	n/a	n/a	ON
- SW1 :	1	2	3	4	5	6	7	8
	←		ALL OFF			→		
- SW1 :	1	2	3	4	5	6	7	8
	OFF	OFF	OFF	OFF	11" : OFF	OFF	ON	OFF
					12" : ON			

10.3.3 GPIB Printers**10.3.3.1 HP QuietJet**

Make sure the dip switches on the backplane of the printer are set to

- SRQ enable: 0
- GPIB listen only:
 - Listen always: 1
 - A5 to A1: 0 0 1 1 1
- GPIB Addressed:
 - Listen always: 0
 - A5 to A1: 0 0 1 1 1

10.3.3.2 HP ThinkJet (HP 2225A)

Make sure the dip switches on the backplane of the printer are set to

- SRQ Enable: 0
- GPIB listen only:
 - Listen always 1
 - A5 to A1: 0 0 1 1 1
- GPIB Addressed:
 - Listen always: 0
 - A5 to A1: 0 0 1 1 1

10.3.3.3 HP PaintJet (black/white only)

Make sure the dip switches near the GPIB connector are set to:

- GPIB Listen only:
 - NORM/SCS: NORM
 - A3 to A1: 1 1 1
 - PC8/ROM8: N/A
 - ENG/MET: has to match paper size ENG = 11" MET = 12"
- GPIB addressed:
 - NORM/SCS: NORM
 - A3 to A1: any combination except 1 1 1
(correspond to add. 0-6)
 - PC8/ROM8: N/A
 - ENG/MET: has to match paper size ENG = 11" MET = 12"

10.4 Information on GPIB

10.4.1 Introduction

This section is a simple description of the GPIB interface as an aid to understanding the interface in the 9314A/M/L DSO: it is not intended as a complete specification of the system.

The GPIB system is designed for the interaction of a number of devices, which may transmit or receive information as required. The system includes data lines over which the actual data are sent, bus management lines for control, and handshake lines to ensure correct acceptance of data at the right destination. The main features of the bus are summarized below:

Maximum number of devices	15
Maximum bus length	20 meters or 2 meters per device, whichever is less.
Connection	star or chain

Note that more than half of any connected devices must be powered up, even if they will not be used.

Data lines	8 DIO	1 to 8
Handshake lines	DAV NRFD NDAC	Data available Not ready for data not data accepted
Bus management lines	EOI IFC SRQ ATN REN	End or identity Interface clear Service request Attention Remote enable
Active level	+0.4 V	
Inactive level	+3,3 V	

Note that all signal lines are active low, and that they are wire 0Red to allow participation by all devices.

In addition, there are 8 ground lines, making a total of 24 lines.

10.4.2 Functions in the GPIB

In order to allow satisfactory interconnection of several devices the following functions must be provided

- Enabling any device to transmit data
- Preventing any device from transmitting data
- Enabling any device to receive data

- Preventing any device to receive data
- Transmitting data to a specific device
- Ensuring that only one device is transmitting
- Ensuring that transmitting takes place only when reception is possible
- Enabling any device to request servicing
- Identify type of data to be sent

Any device can be activated into the "talk" or "listen" state, and can be deactivated by the commands "untalk" and "unlisten". Also a device can be a "controller".

Maximum number of current talkers	1
Maximum number of current listeners	14
Maximum number of current controllers	1

Function of bus lines:

- DAV Data available; talker says the data on the line are valid.
- NRFD Not ready for data; listener says it is not ready for more data.
All listeners must release the NRFD line, i.e., let it go high, before talker can send.
- NDAC Not data accepted; listener says it has not yet accepted the data. Talker must hold all data lines steady until all listeners have released this line, i.e., it goes high.

Clearly, the NRFD and NDAC are easy to implement by a wired OR system, so that any one device asserting the signal prevents progress to the next step. Progress is made at the speed of the slowest listener. A simple timing diagram is given in figure 10.1, and another way of presenting the system is given in figure 10.2.

The bus management lines functions as follows:

- EOI End Or Identify; talker sends this with last byte of a block transfer to indicate last byte. Also used with ATN to parallel poll devices for their status bit.
- IFC InterFace Clear; places the GPIB system into a quiescent state.
- SRQ Service ReQuest; any device can send it to the controller to indicate need for attention, and to request interruption of current operations.
- ATN ATeNtion; controller sends this to specify whether DIO lines are to be used for interface messages, e.g., addressing, or for data.
- REN Remote ENable; selects a device as being under local or remote control.

Addressing of the devices on the GPIB bus consult a specialized GPIB-IEEE488 document.

The principles of GPIB are quite simple - the system must wait for all users, and lines are wire ORed so that all can pull the lines down. The handshake sequence is illustrated in two ways. In figure 10.1 the signal waveforms are sketched, while figure 10.2 is a flowchart.

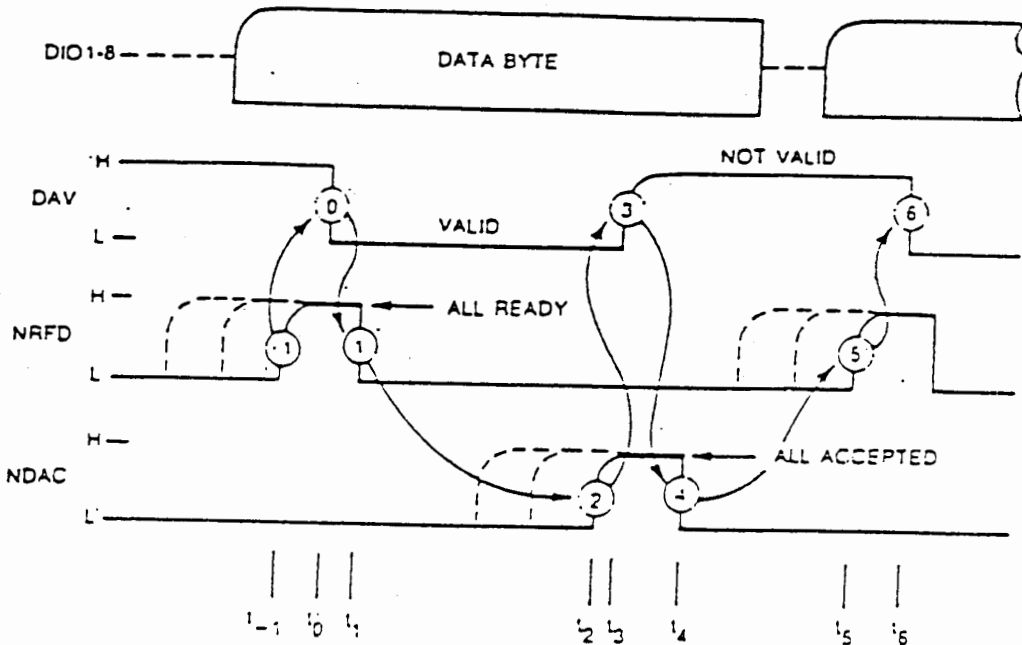

Figure 10.1 : DATA BYTE TRANSFER IN GPIB IEEE-488

The handshake timing sequence proceeds as follows:

- | | |
|-------------|---|
| Preliminary | The source checks for presence of listeners and places the next data byte on the data lines DIO1-8. |
| t-1 | Acceptors one by one become ready for byte. Last one allows NRFD to go high. |
| t0 | Source pulls down DAV to validate data. |
| t1 | The first listener to accept the data pulls down NRFD to show it is no longer ready for a new byte. |
| t2 | The listeners one by one accept the data, and the last one lets NDAC go high. |
| t3 | The source sets DAV high to show this byte is no longer valid. |
| t4 | The listeners one by one accept this, the first one pulling NDAC low for the next cycle. |
| t5 | As for t-1. |

THIS PAGE INTENTIONALLY LEFT BLANK



LeCroy

LeCroy Corporation
700 Chestnut Ridge Road
Chestnut Ridge NY 10977-6499 USA
Phone: 1-800-5-LECROY 1-914-425-2000
FAX: 1-914-425-8967
www.lecroy.com